



EHL171/EHL173

Mini-ITX Industrial Motherboard
User's Manual

Copyright

This publication contains information that is protected by copyright. No part of it may be reproduced in any form or by any means or used to make any transformation/adaptation without the prior written permission from the copyright holders.

This publication is provided for informational purposes only. The manufacturer makes no representations or warranties with respect to the contents or use of this manual and specifically disclaims any express or implied warranties of merchantability or fitness for any particular purpose. The user will assume the entire risk of the use or the results of the use of this document. Further, the manufacturer reserves the right to revise this publication and make changes to its contents at any time, without obligation to notify any person or entity of such revisions or changes.

Changes after the publication's first release will be based on the product's revision. The website will always provide the most updated information.

© 2022. All Rights Reserved.

Trademarks

Product names or trademarks appearing in this manual are for identification purpose only and are the properties of the respective owners.

FCC and DOC Statement on Class B

This equipment has been tested and found to comply with the limits for a Class B digital device, pursuant to Part 15 of the FCC rules. These limits are designed to provide reasonable protection against harmful interference when the equipment is operated in a residential installation. This equipment generates, uses and can radiate radio frequency energy and, if not installed and used in accordance with the instruction manual, may cause harmful interference to radio communications. However, there is no guarantee that interference will not occur in a particular installation. If this equipment does cause harmful interference to radio or television reception, which can be determined by turning the equipment off and on, the user is encouraged to try to correct the interference by one or more of the following measures:

- Reorient or relocate the receiving antenna.
- Increase the separation between the equipment and the receiver.
- Connect the equipment into an outlet on a circuit different from that to which the receiver is connected.
- Consult the dealer or an experienced radio TV technician for help.

Notice:

- The changes or modifications not expressly approved by the party responsible for compliance could void the user's authority to operate the equipment.
- Shielded interface cables must be used in order to comply with the emission limits.

Table of Contents

Chapter 1 - Introduction.....	6
Specifications	6
Features	8
Block Diagram	9
Chapter 2 - Hardware Installation.....	10
Board Layout.....	10
System Memory	11
Installing the DIMM Module	11
Removing the DIMM Module.....	12
Jumper Settings.....	13
CLEAR CMOS Data.....	13
Panel Backlight Selection	14
Panel Inverter Power Selection	14
Backlight Dimming Control.....	15
COM1 Power Selection	16
COM2 Power Selection	16
Rear I/O Ports.....	17
USB Ports.....	17
Graphics Interfaces	18
RJ45 LAN Ports	19
Audio	19
Internal I/O Connectors	20
SATA (Serial ATA).....	20
Digital I/O Connector.....	20
COM (Serial) ports.....	21
Cooling Fan Connectors.....	22
InnoAGE HDR1	22
Front Panel.....	23
S/PDIF Connector.....	23
Expansion Slots	24
Installing the M.2 Module	24
Battery Header.....	25
DIO Power	26
LVDS Backlight.....	26
Chapter 3 - BIOS Settings.....	27
Overview	27
Main.....	28
Advanced	28
RC ACPI Configuration.....	29
CPU Configuration.....	29
Power & Performance	30
PCH-FW Configuration	30
Trusted Computing.....	31
PTN3460 Configuration	31
NCT6126D Super IO Configuration	32
NCT6126D HW Monitor	33
Serial Port Console Redirection	34
USB Configuration	35
Network Stack Configuration.....	36
USB Power Control.....	36
Chipset	37
Memory Configuration	37

Graphics Configuration	38
PCH-IO Configuration	39
PCI Express Configuration	39
SATA And RST Configuration	40
HD Audio Configuration	40
Security	41
Secure Boot.....	41
Boot	43
Save & Exit	43
Updating the BIOS.....	44
Notice: BIOS SPI ROM.....	44

About this Manual

This manual can be downloaded from the website.

The manual is subject to change and update without notice, and may be based on editions that do not resemble your actual products. Please visit our website or contact our sales representatives for the latest editions.

Warranty

- Warranty does not cover damages or failures that occur from misuse of the product, inability to use the product, unauthorized replacement or alteration of components and product specifications.
- The warranty is void if the product has been subjected to physical abuse, improper installation, modification, accidents or unauthorized repair of the product.
- Unless otherwise instructed in this user's manual, the user may not, under any circumstances, attempt to perform service, adjustments or repairs on the product, whether in or out of warranty. It must be returned to the purchase point, factory or authorized service agency for all such work.
- We will not be liable for any indirect, special, incidental or consequential damages to the product that has been modified or altered.

Static Electricity Precautions

It is quite easy to inadvertently damage your PC, system board, components or devices even before installing them in your system unit. Static electrical discharge can damage computer components without causing any signs of physical damage. You must take extra care in handling them to ensure against electrostatic build-up.

- To prevent electrostatic build-up, leave the system board in its anti-static bag until you are ready to install it.
- Wear an antistatic wrist strap.
- Do all preparation work on a static-free surface.
- Hold the device only by its edges. Be careful not to touch any of the components, contacts or connections.
- Avoid touching the pins or contacts on all modules and connectors. Hold modules or connectors by their ends.



Important:

Electrostatic discharge (ESD) can damage your processor, disk drive and other components. Perform the upgrade instruction procedures described at an ESD workstation only. If such a station is not available, you can provide some ESD protection by wearing an antistatic wrist strap and attaching it to a metal part of the system chassis. If a wrist strap is unavailable, establish and maintain contact with the system chassis throughout any procedures requiring ESD protection.

Safety Measures

- To avoid damage to the system, use the correct AC input voltage range.
- To reduce the risk of electric shock, unplug the power cord before removing the system chassis cover for installation or servicing. After installation or servicing, cover the system chassis before plugging the power cord.

About the Package

The package contains the following items. If any of these items are missing or damaged, please contact your dealer or sales representative for assistance.

- 1 EHL171/EHL173 motherboard
- 1 COM port cable (Length: 250mm, 1 x COM ports) A81-015011-001G
- 1 Serial ATA data with power cable (Length: 250mm) A81-002013-000G
- 1 Heat sink TBD

The board and accessories in the package may not come similar to the information listed above. This may differ in accordance with the sales region or models in which it was sold. For more information about the standard package in your region, please contact your dealer or sales representative.

Optional Items

The board and accessories in the package may not come similar to the information listed above. This may differ in accordance with the sales region or models in which it was sold. For more information about the standard package in your region, please contact your dealer or sales representative.

Before Using the System Board

When installing the system board in a new system, you will need at least the following internal components.

- Memory module
- Storage device such as a hard disk drive.
- Power supply

External system peripherals may also be required for navigation and display, including at least a keyboard, a mouse and a video display monitor.

Chapter 1 - Introduction

► Specifications

Model Name		EHL171	EHL173
SYSTEM	Processor	Intel Atom® X Series Processors, BGA 1493 Intel® Atom® x6425E Processor, Quad Core, 1.5M Cache, 2.0GHz (3.0GHz), 12W Intel® Atom® x6211E Processor, Dual Core, 1.5M Cache, 1.3GHz (3.0GHz), 6W Intel® Atom® x6413E Processor, Quad Core, 1.5M Cache, 1.5GHz (3.0GHz), 9W Intel® Celeron® J6413 Processor, Quad Core, 1.5M Cache, 1.8GHz (3.0GHz), 10W	
	Memory	Two 260-pin SODIMM up to 32GB Dual channel DDR4 up to 3200MHz (in-band ECC support in embedded/industrial SKU)	Two 260-pin SODIMM up to 32GB Dual channel DDR4 up to 3200MHz (in-band ECC support in embedded/industrial SKU)
	BIOS	AMI SPI 256Mbit (supports UEFI boot only)	AMI SPI 256Mbit (supports UEFI boot only)
GRAPHICS	Controller	Intel® UHD Graphics	Intel® UHD Graphics
	Feature	OpenGL 4.5, DirectX 12, Open CL 1.2, Vulkan 1.1 HW Decode: AVC/H.264, MPEG2, VC1/WMV9, JPEG/MJPEG, HEVC/H.265, VP8, VP9 HW Encode: AVC/H.264, JPEG/MJPEG, HEVC/H.265, VP9	OpenGL 4.5, DirectX 12, Open CL 1.2, Vulkan 1.1 HW Decode: AVC/H.264, MPEG2, VC1/WMV9, JPEG/MJPEG, HEVC/H.265, VP8, VP9 HW Encode: AVC/H.264, JPEG/MJPEG, HEVC/H.265, VP9
	Display	1 x DP++ (Colay VGA, MOQ required) 1 x HDMI 2.0 (Colay DP++, MOQ required) 1 x eDP/LVDS (eDP in priority) HDMI: resolution up to 4096x2160 @24Hz DP++: resolution up to 4096x2160 @ 60Hz eDP: resolution up to 4096x2160 @ 60Hz VGA: resolution up to 2560x1600 @ 60Hz LVDS: resolution up to 1920x1200 @ 60Hz	1 x DP++ (Colay VGA, MOQ required) 1 x HDMI 2.0 (Colay DP++, MOQ required) 1 x eDP/LVDS (eDP in priority) HDMI: resolution up to 4096x2160 @24Hz DP++: resolution up to 4096x2160 @ 60Hz eDP: resolution up to 4096x2160 @ 60Hz VGA: resolution up to 2560x1600 @ 60Hz LVDS: resolution up to 1920x1200 @ 60Hz
	Triple Displays	DP++/VGA + HDMI/DP++ + eDP/LVDS	DP++/VGA + HDMI/DP++ + eDP/LVDS
EXPANSION	Interface	1 x PCIe x4 (Default: PCIe x1 signal with M.2 B key active/ Opt: PCIe x2 signal with M.2 B key inactive) 1 x M.2 2242/2280/3052 B Key (PCIe x1/SATA/USB2.0) 1 x M.2 2230 E Key (PCIe x1/USB2.0) 1 x Nano SIM socket (connected to M.2 B key)	1 x PCIe x4 (Default: PCIe x1 signal with M.2 B key active/ Opt: PCIe x2 signal with M.2 B key inactive) 1 x M.2 2242/2280/3052 B Key (PCIe x1/SATA/USB2.0) 1 x M.2 2230 E Key (PCIe x1/USB2.0) 1 x Nano SIM socket (connected to M.2 B key)
AUDIO	Audio Codec	Realtek ALC888	Realtek ALC888
ETHERNET	Phy	-40~85°C: 2 x Intel® I225IT (10/100/1000/2500Mbps) or -5~65°C: 2 x Intel® I225LM (10/100/1000/2500Mbps)	-40~85°C: 2 x Intel® I225IT (10/100/1000/2500Mbps) or -5~65°C: 2 x Intel® I225LM (10/100/1000/2500Mbps)
REAR I/O	Ethernet	2 x 2.5GHz RJ45	2 x 2.5GHz RJ45
	USB	2 x USB 3.2 Gen2 2 x USB 3.2 Gen1	2 x USB 3.2 Gen2 2 x USB 3.2 Gen1
	Display	1 x HDMI/DP++ (opt., MOQ required) 1 x DP++ /VGA (opt., MOQ required)	1 x HDMI/DP++ (opt., MOQ required) 1 x DP++ /VGA (opt., MOQ required)
	Audio	1 x Line-out	1 x Line-out

INTERNAL I/O	Serial	2 x RS-232/422/485 (RS-232 w/ power) (2.0mm pitch) 4 x RS-232 (2.0mm pitch)	2 x RS-232/422/485 (RS-232 w/ power) (2.0mm pitch) 4 x RS-232 (2.0mm pitch)
	USB	4 x USB 2.0 (2.0mm pitch) or 2 x USB 2.0 (2.00mm pitch) + 1 x Vertical USB 2.0 (type A) (opt., MOQ required)	4 x USB 2.0 (2.0mm pitch) or 2 x USB 2.0 (2.00mm pitch) + 1 x Vertical USB 2.0 (type A) (opt., MOQ required)
	Display	1 x eDP LCD Panel Connector (Colay LVDS LCD, auto-detection) 1 x LCD/Inverter Power	1 x eDP LCD Panel Connector (Colay LVDS LCD, auto-detection) 1 x LCD/Inverter Power
	Audio	1 x S/PDIF 1 x Line-in/Mic-in	1 x S/PDIF 1 x Line-in/Mic-in
	SATA	2 x SATA 3.0 (up to 6Gb/s) (one SATA port shared with M.2 B key)	2 x SATA 3.0 (up to 6Gb/s) (one SATA port shared with M.2 B key)
	DIO	1 x 8-bit DIO	1 x 8-bit DIO
	SMBus	1 x SMBus	1 x SMBus
WATCHDOG TIMER	Output & Interval	System Reset, Programmable via Software from 1 to 255 Seconds	System Reset, Programmable via Software from 1 to 255 Seconds
SECURITY	TPM	fTPM (default) dTPM (option)	fTPM (default) dTPM (option)
POWER	Type	Single 12V +/-10% DC (DC-In jack by default)	Wide Range 9~36V (4P vertical type by default)
	Connector	DC-in Jack Right Angle Connector (4-pin) Vertical Type Connector (4-pin)	DC-in Jack Right Angle Connector (4-pin) Vertical Type Connector (4-pin)
	Consumption	Idle: Celeron J6413 10W: 12V @ 0.66A (7.92W) Max: Celeron J6413 10W: 12V @ 1.98A (23.76W)	Idle: Celeron J6413 10W: 12V @ 0.66A (7.92W) Max: Celeron J6413 10W: 12V @ 1.98A (23.76W)
	RTC Battery	CR2032 Coin Cell	CR2032 Coin Cell
OS SUPPORT	Microsoft	Windows 10 IoT Enterprise 64-bit Windows 11 GAC	Windows 10 IoT Enterprise 64-bit Windows 11 GAC
	Linux	Linux	Linux
ENVIRONMENT	Temperature	Operating: -5 to 65°C, -40 to 85°C Storage: -40 to 85°C	Operating: -5 to 65°C, -40 to 85°C Storage: -40 to 85°C
	Humidity	Operating: 5 to 90% RH Storage: 5 to 90% RH	Operating: 5 to 90% RH Storage: 5 to 90% RH
	MTBF	EHL171-CT-6427FE MTBF 349,721 hrs @ 25°C; 236,303 hrs @ 45°C; 164,112 hrs @ 60°C; 82,397 hrs @ 85°C; Calculation model: Telcordia Issue 4 Environment: GB, GC – Ground Benign, Controlled	EHL173-CT-6425E MTBF 430,473 hrs @ 25°C; 267,529 hrs @ 45°C; 176,755 hrs @ 60°C; 132,188 hrs @ 70°C; 84,901 hrs @ 85°C; Calculation model: Telcordia Issue 4 Environment: GB, GC – Ground Benign, Controlled
MECHANICAL	Dimensions	Mini-ITX Form Factor 170mm (6.7") x 170mm (6.7")	Mini-ITX Form Factor 170mm (6.7") x 170mm (6.7")
	Height	PCB: 1.6mm Top Side: TBD	PCB: 1.6mm Top Side: TBD
STANDARDS AND CERTIFICATIONS	Certifications	CE, FCC, RoHS, UKCA	CE, FCC, RoHS, UKCA

► Features

Watchdog Timer

The Watchdog Timer function allows your application to regularly “clear” the system at the set time interval. If the system hangs or fails to function, it will reset at the set time interval so that your system will continue to operate.

DDR4

DDR4 delivers increased system bandwidth and improves performance. The advantages of DDR4 provide an extended battery life and improve the performance at a lower power than DDR3/DDR2.

Serial ATA

Serial ATA is a storage interface that is compliant with SATA 1.0a specification. With speed of up to 6Gb/s (SATA 3.0), it improves hard drive performance faster than the standard parallel ATA whose data transfer rate is 100MB/s.

Gigabit LAN

Two Intel® Ethernet Controller I225 support up to 2.5GbE data transmission.

Wake-On-LAN

This feature allows the network to remotely wake up a Soft Power Down (Soft-Off) PC. It is supported via the onboard LAN port or via a PCI LAN card that uses the PCI PME (Power Management Event) signal. However, if your system is in the Suspend mode, you can power-on the system only through an IRQ or DMA interrupt.

Wake-On-USB

This function allows you to use a USB keyboard or USB mouse to wake up a system from the S3 (STR - Suspend To RAM) state.

PCI Express

PCI Express is a high bandwidth I/O infrastructure that possesses the ability to scale speeds by forming multiple lanes. The x4 PCI Express lane supports transfer rate of 4 Gigabyte per second (2 directions). The PCI Express architecture also supports high performance graphics infrastructure by enhancing the capability of a PCIe x16 Gen 3 at 16GB/s bandwidth (8GB/s in each direction).

ACPI STR

The system board is designed to meet the ACPI (Advanced Configuration and Power Interface) specification. ACPI has energy saving features that enables PCs to implement Power Management and Plug-and-Play with operating systems that support OS Direct Power Management. ACPI when enabled in the Power Management Setup will allow you to use the Suspend to RAM function.

With the Suspend to RAM function enabled, you can power-off the system at once by pressing the power button or selecting “Standby” when you shut down Windows® without having to go through the sometimes tiresome process of closing files, applications and operating system. This is because the system is capable of storing all programs and data files during the entire operating session into RAM (Random Access Memory) when it powers-off. The operating session will resume exactly where you left off the next time you power-on the system.

Power Failure Recovery

When power returns after an AC power failure, you may choose to either power-on the system manually or let the system power-on automatically.

USB

The system board supports the new USB 3.1 Gen 2. It is capable of running at a maximum transmission speed of up to 10 Gbit/s (1250 MB/s), and is faster than USB 2.0 (480 Mbit/s, or 60 MB/s) and USB 1.1 (12Mb/s). USB 3.1 reduces the time required for data transmission, reduces power consumption, and is backward compatible with USB 2.0. It is a marked improvement in device transfer speeds between your computer and a wide range of simultaneously accessible external Plug and Play peripherals.

RTC Timer

The Real Time Clock (RTC) installed on the system board allows your system to automatically power-on on the set date and time.

► Block Diagram

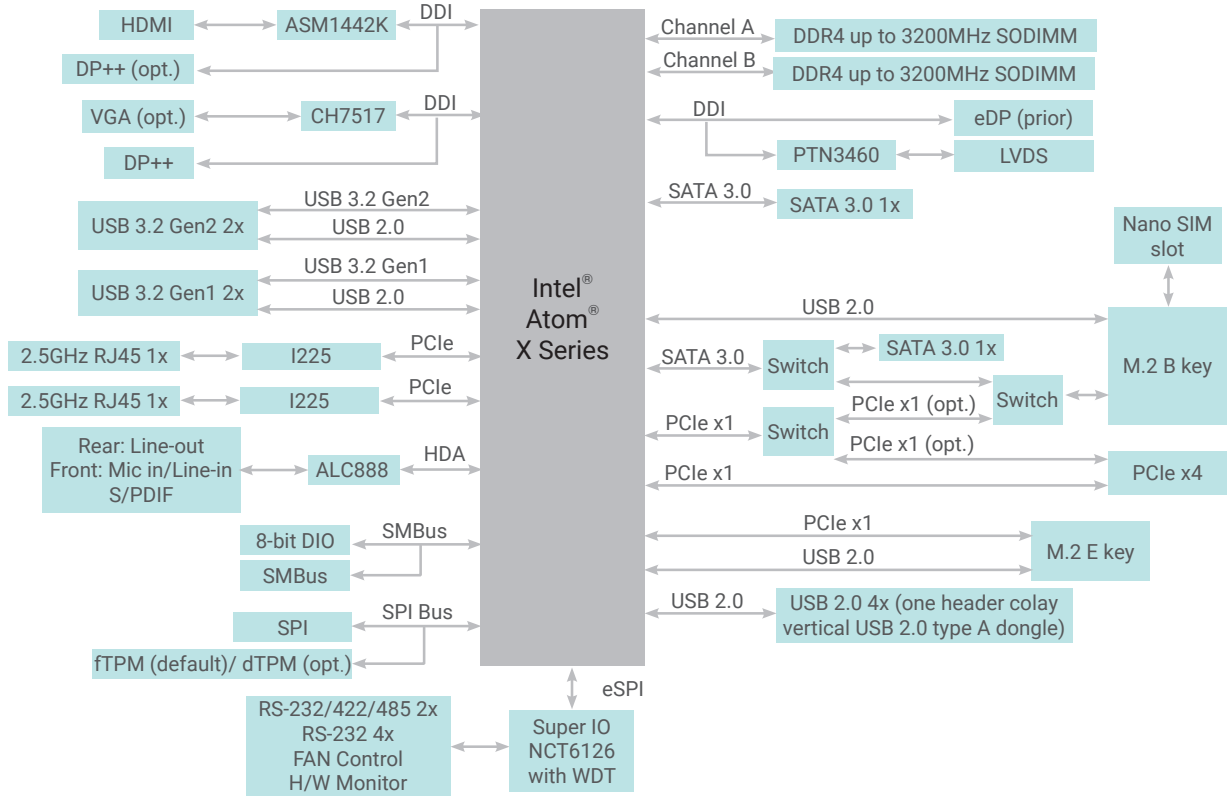

Chapter 2 - Hardware Installation

► Board Layout

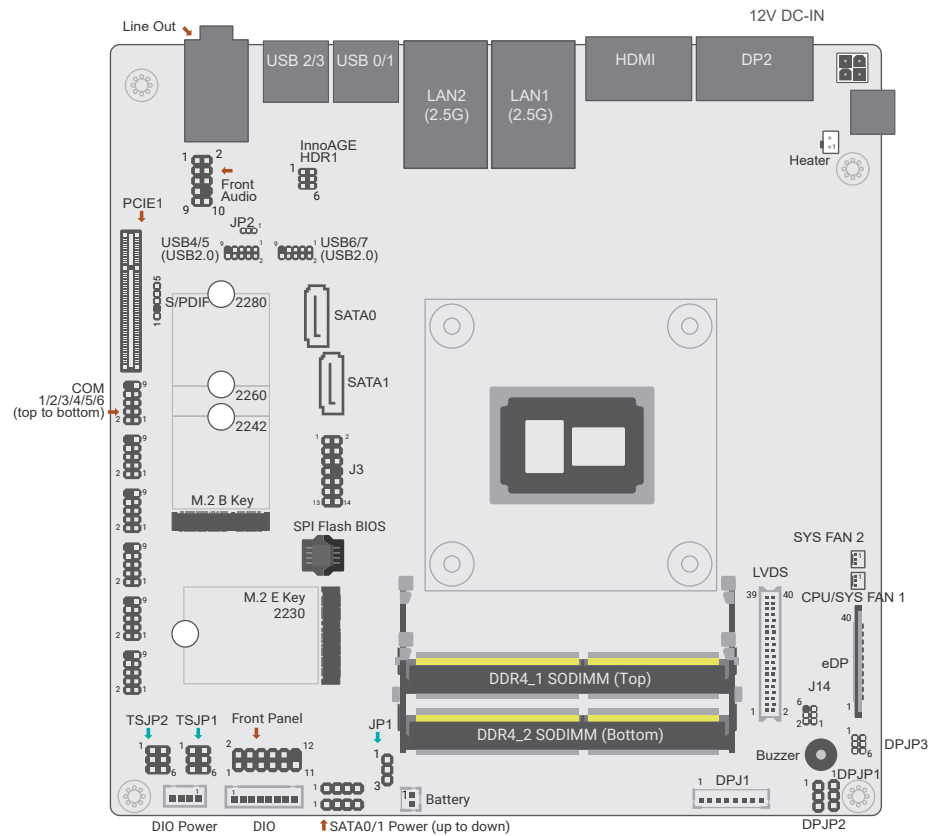

Note:
 Some components are optional and only available upon request.



Important:
 Electrostatic discharge (ESD) can damage your board, processor, disk drives, add-in boards, and other components. Perform installation procedures at an ESD workstation only. If such a station is not available, you can provide some ESD protection by wearing an antistatic wrist strap and attaching it to a metal part of the system chassis. If a wrist strap is unavailable, establish and maintain contact with the system chassis throughout any procedures requiring ESD protection.

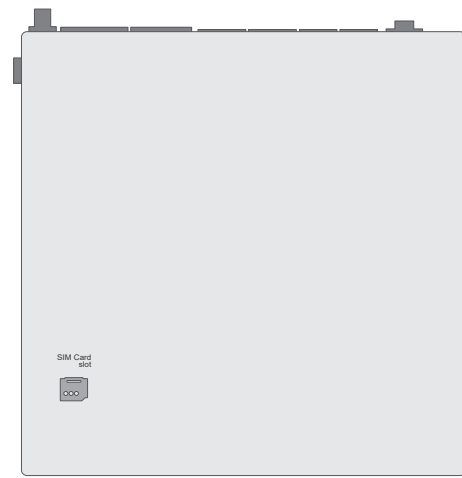

► System Memory

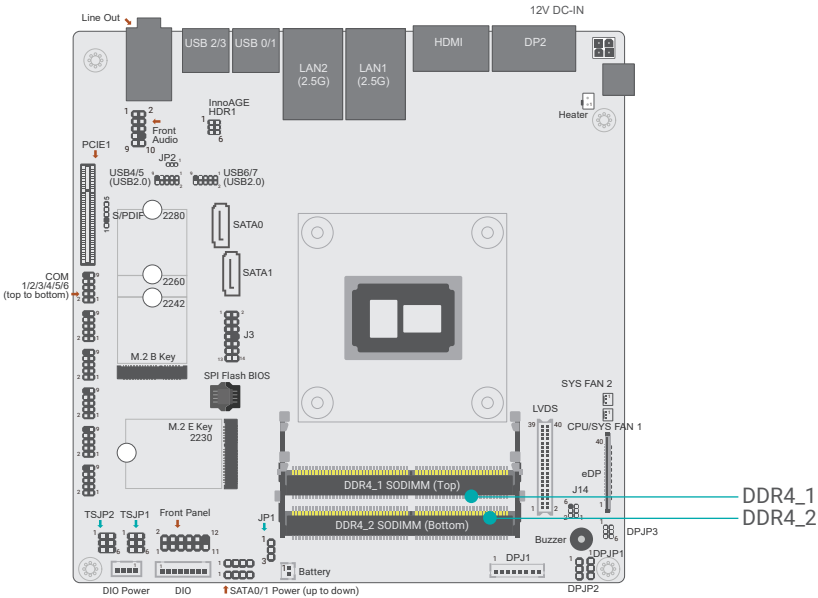

The system board supports the following memory interface.

Single Channel (SC)

Data will be accessed in chunks of 64 bits from the memory channels. DIMMs are on the same channel. DIMMs in a channel can be identical or completely different. However, we highly recommend using identical DIMMs. Not all slots need to be populated.

Dual Channel (DC)

Data will be accessed in chunks of 128 bits from the memory channels. Dual channel provides better system performance because it doubles the data transfer rate.

Features

- Two 260-pin SODIMM up to 32GB
- Dual channel DDR4 up to 3200MHz (in-band ECC support in embedded/ industrial SKU)

► System Memory

Installing the DIMM Module

Before installing the memory module, please make sure that the following safety cautions are well-attended.

- Make sure the PC and all other peripheral devices connected to it has been powered down.
- Disconnect all power cords and cables.
- Locate the DIMM socket on the system board
- Make sure the notch on memory card is aligned to the key on the socket.

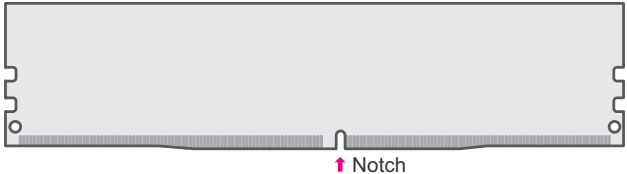

Memory Module

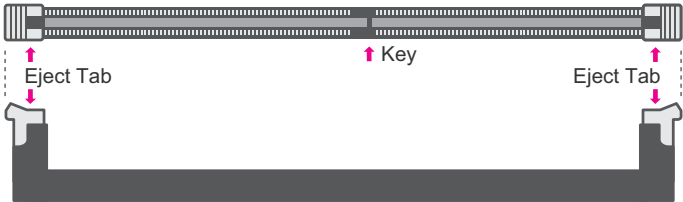

Socket Top View

Socket Side View

► System Memory ► Installing the DIMM Module

Please follow the steps below to install the memory card into the socket.

Step 1:
Press the eject tabs at both ends of the socket outward and downward to release them from the locked position.

Step 2:
Insert the memory card into the slot while making sure the notch and the key are aligned. Press the card down firmly with fingers while applying and maintaining even pressure on both ends.

Step 3:
The tabs snap automatically to the edges of the card and lock the card in place.

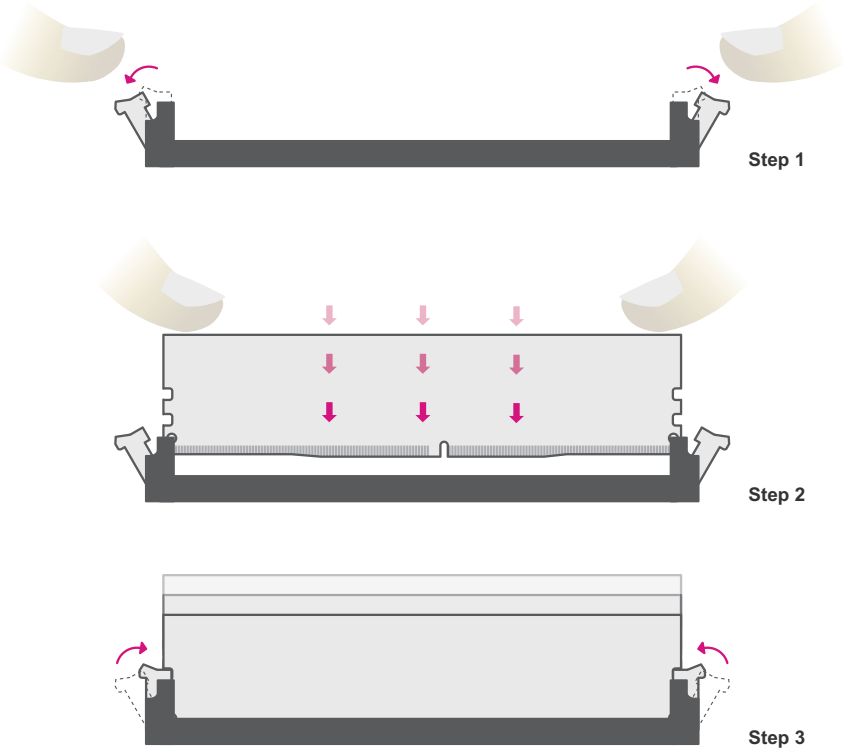

► System Memory

Removing the DIMM Module

Please follow the steps below to remove the memory card from the socket.

Step 1:
Press the eject tabs at both ends of the socket outward and downward to release them from the locked position.

Step 2:
The memory card ejects from the slot automatically.

Step 3:
Hold the card by its edges and remove it from the slot.

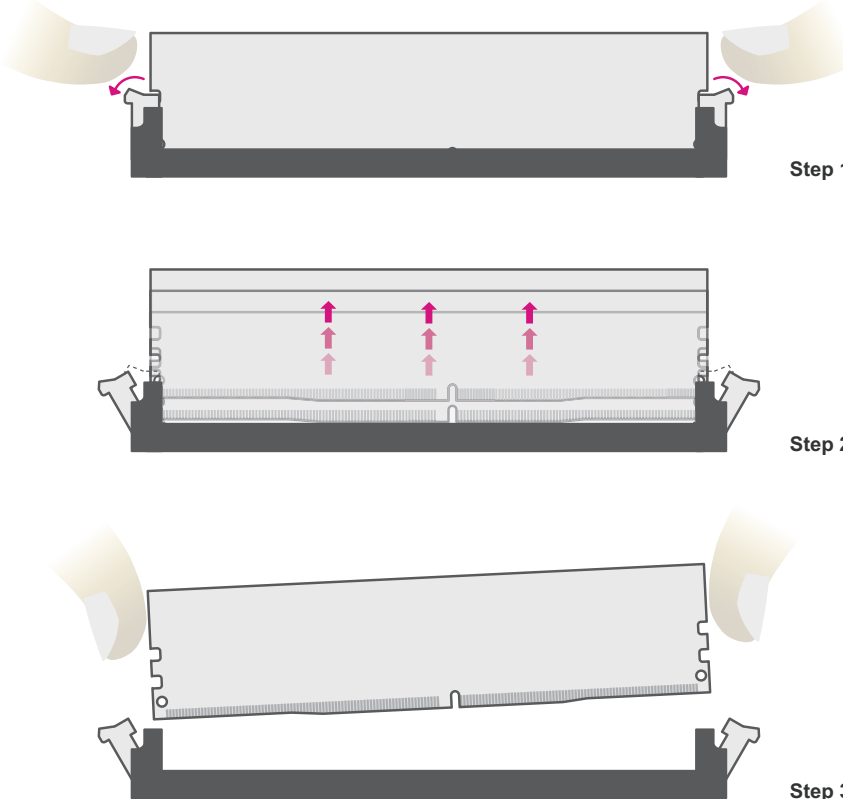

► Jumper Settings

CLEAR CMOS Data

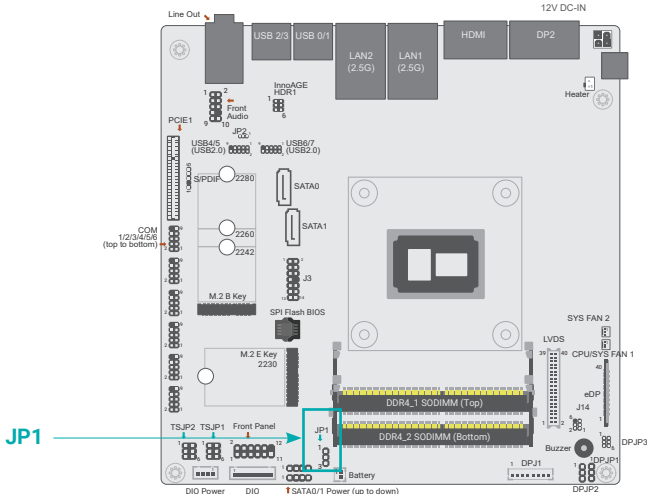

If any anomaly of the followings is encountered –

- a) CMOS data is corrupted;
- b) you forgot the supervisor or user password;
- c) failure to start the system due to BIOS mis-configuration

– it is suggested that the system be reconfigured with default values stored in the ROM BIOS. To load the default values stored in the ROM BIOS, please follow the steps below.

1. Power-off the system and unplug the power cord.
2. Put a jumper cap on pin 2 and pin 3. Wait for a few seconds and set it back to its default setting, i.e. jumper cap on pin 1 and pin 2.
3. Plug the power cord and power-on the system.

Clear CMOS	JP1
Normal (default)	1-2 On
Clear CMOS Data	2-3 On

► Jumper Settings

Panel Backlight Selection

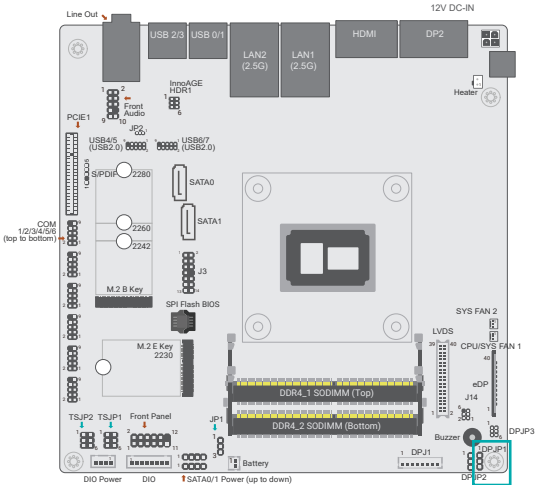

This jumper is to determine the power of panel backlight.

Panel Backlight Selection	DPJP1
3.3V(default)	1-2 On
5V	2-3 On

Panel Inverter Power Selection

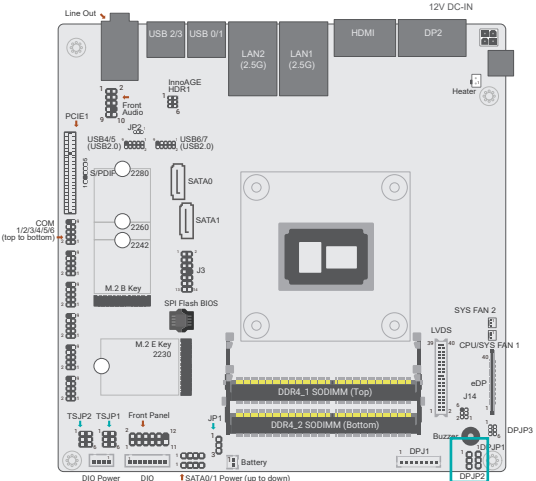

This jumper is to determine the power of panel inverter.

Panel Inverter Power Selection	DPJP2
12V(default)	1-2 On
5V	2-3 On

► **Jumper Settings**

Backlight Dimming Control

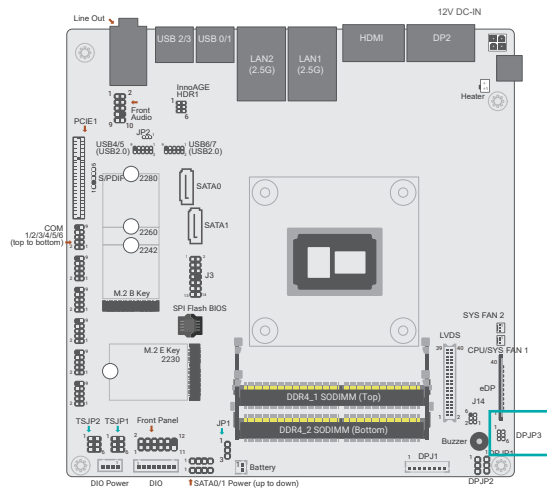

This jumper is to determine the dimming of panel backlight.

Panel Power Jumper	DPJP3
12V	1-2 On
5V	3-4 On
3.3V(default)	5-6 On

► **Jumper Settings**

COM1 Power Selection

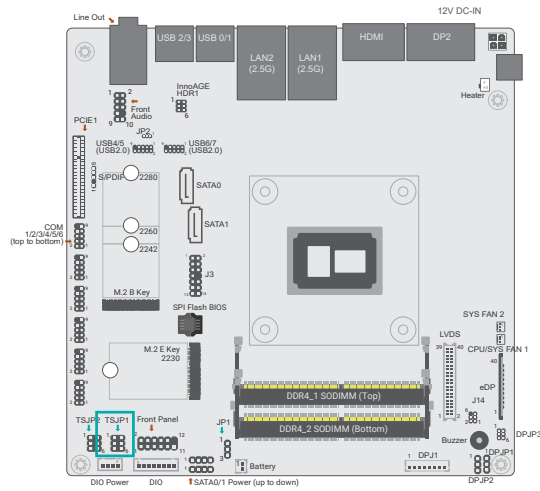

This jumper is to determine the COM1 Power.

COM 1 Power Selection

TSJP1

RS232 Standard (Deafult)	1-3 On / 2-4 On
RS232 With Power	3-5 On / 4-6 On

COM2 Power Selection

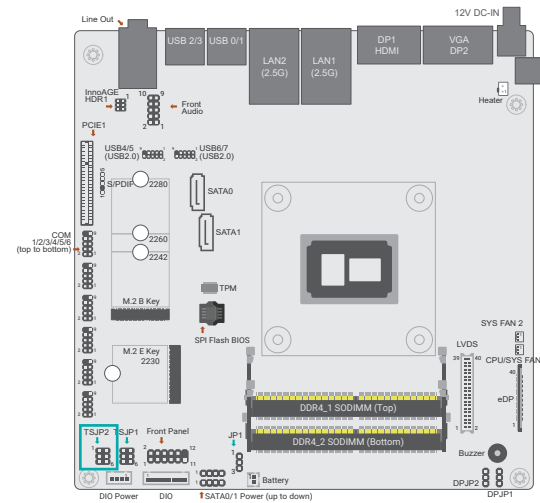

This jumper is to determine the COM2 Power.

COM 2 Power Selection

TSJP2

RS232 Standard (Deafult)	1-3 On / 2-4 On
RS232 With Power	3-5 On / 4-6 On

► **Rear I/O Ports**

USB Ports

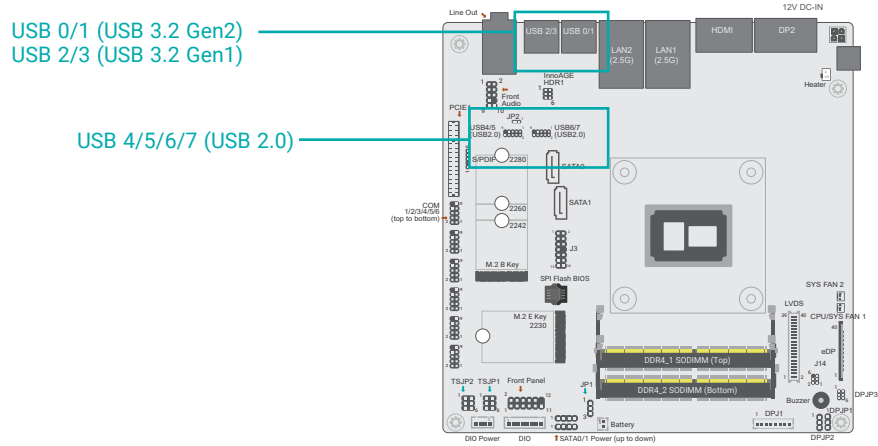

■ USB 2.0 Headers (USB 4/5/6/7)

Pin	Function	Pin	Function
1	5V_USB45(67)	2	5V_USB45(67)
3	USB2_4(6)_C_N	4	USB2_5(7)_C_N
5	USB2_4(6)_C_P	6	USB2_5(7)_C_P
7	GND	8	GND
9	---	10	N.C.

The USB device allows data exchange between your computer and a wide range of simultaneously accessible external Plug and Play peripherals. The system board is equipped with multiple USB ports as listed below:

- 2 x USB 3.2 Gen 2 rear ports (USB 0/1)
- 2 x USB 3.2 Gen 1 rear ports (USB 2/3)
- 4 x USB 2.0 internal ports, box headers (USB 4/5/6/7)

The internal USB ports may be mounted on a card-edge bracket. Install the card-edge bracket to an available slot at the rear of the system chassis and then insert the USB port cables to a connector.

Wake-On-USB Keyboard/Mouse

The Wake-On-USB Keyboard/Mouse function allows you to use a USB keyboard or USB mouse to wake up a system from the S3 (STR - Suspend To RAM) state.

► **Rear I/O Ports**

Graphics Interfaces

The display ports consist of the following:

- 1 DP++ Port
- 1 HDMI port

DP++ Port

The DP++ port which carries both digital audio and video signals is used to connect a LCD monitor or a digital TV that has the DP++ port.

HDMI Port

The HDMI port which carries both digital audio and video signals is used to connect a LCD monitor or digital TV that has the HDMI port.

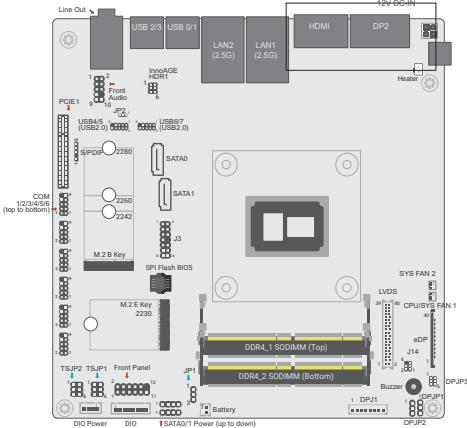

► Rear I/O Ports

RJ45 LAN Ports

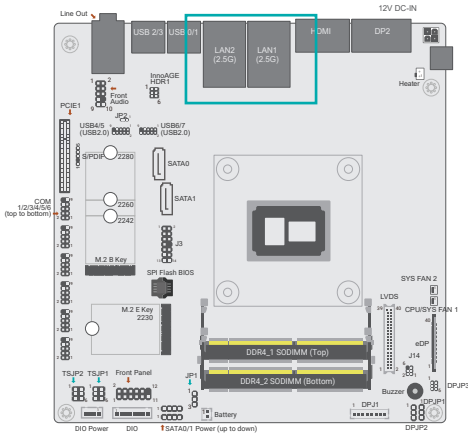

Features

- 2 x GbE (RJ-45)

The LAN ports allow the system board to connect to a local area network by means of a network hub.

► Rear I/O Ports

Audio

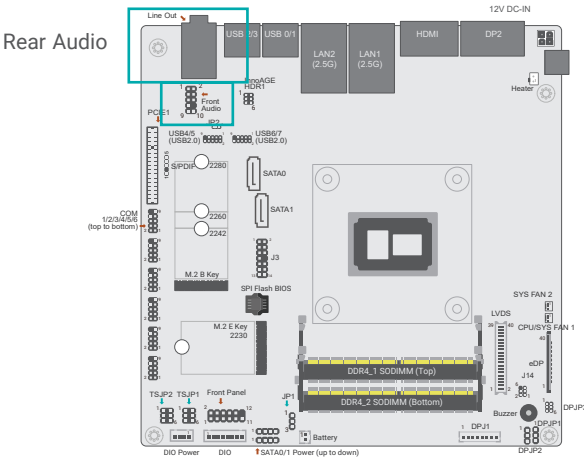

Rear Audio

The system board is equipped with 1 audio jacks (Line-out). A jack is a one-hole connecting interface for inserting a plug.

Front Audio

The front audio connector allows you to connect to the second line-out and mic-in jacks that are at the front panel of your system.

Pin	Function	Pin	Function
1	MIC2-L	2	AGND_AUDIO
3	MIC2-R	4	N.C.
5	LINE2-R	6	MIC2-JD
7	AGND_AUDIO	8	--
9	LINE2-L	10	LINE2-JD

► **Internal I/O Connectors**

SATA (Serial ATA)

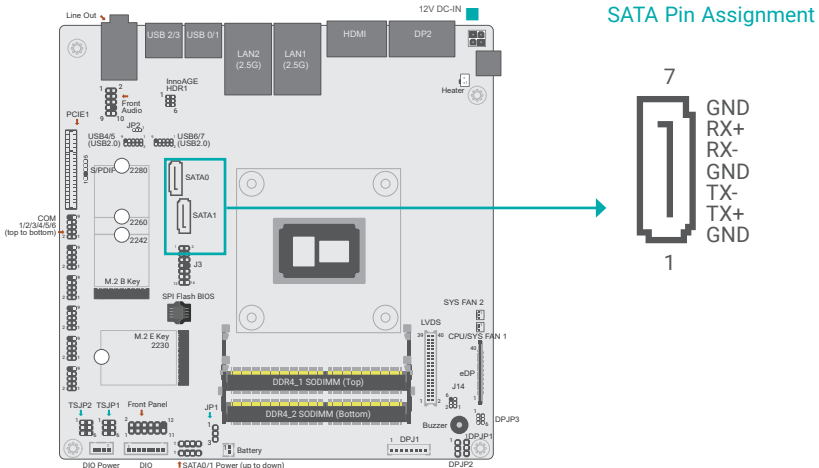

The Serial ATA (SATA) connectors are used to connect the Serial ATA device. SATA 3.0 is supported by the 2 SATA ports and provides data rate up to 6Gb/s. Connect one end of the Serial ATA cable to a SATA connector and the other end to your Serial ATA device.

Features

- 2 Serial ATA 3.0 ports with data transfer rate up to 6Gb/s
- Integrated Advanced Host Controller Interface (AHCI) controller

► **Internal I/O Connectors**

Digital I/O Connector

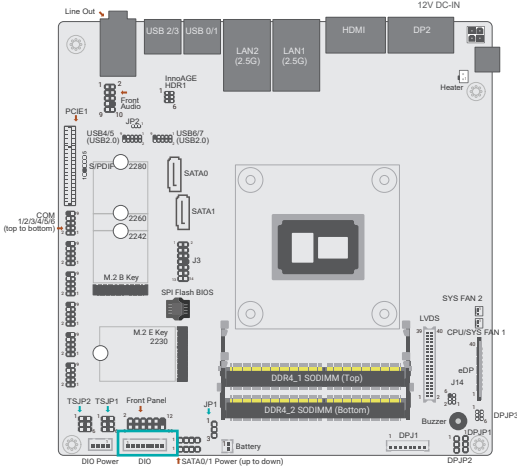

The 8-bit Digital I/O connector provides powering-on function to external devices that are connected to these connectors. The pin functions of the 8-bit digital I/O connector are listed below.

Pin	Function
1	D_IOA0_C
2	D_IOA1_C
3	D_IOA2_C
4	D_IOA3_C
5	D_IOA4_C
6	D_IOA5_C
7	D_IOA6_C
8	D_IOA7_C

► **Internal I/O Connectors**

COM (Serial) ports

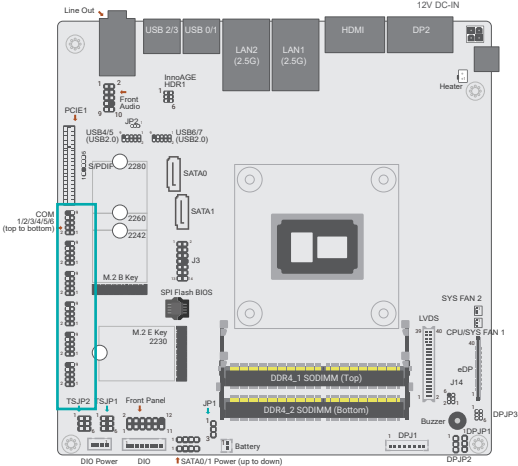

COM1

Pin	Function	Pin	Function
1	MDCD1-/ RS422_RX+ / RS485_D+	2	MSIN1-/ RS422_RX- / RS485_D-
3	MSO1-/RS422_ TX+	4	MDTR1-/RS422_TX-
5	GND	6	MDSR1-
7	MRTS1-	8	MCTS1-
9	MRI1-	10	--

COM2

Pin	Function	Pin	Function
1	MDCD2-/ RS422_RX+ / RS485_D+	2	MSIN2-/ RS422_RX- / RS485_D-
3	MSO2-/RS422_ TX+	4	MDTR2-/ RS422_TX-
5	GND	6	MDSR2-
7	MRTS2-	8	MCTS2-
9	MRI2 -	10	--

COM3

Pin	Function	Pin	Function
1	MDCD3-	2	MSIN3-
3	MSO3-	4	MDTR3-
5	GND	6	MDSR3-
7	MRTS3-	8	MCTS3-
9	MRI3 -	10	--

COM4

Pin	Function	Pin	Function
1	MDCD4-	2	MSIN4-
3	MSO4-	4	MDTR4-
5	GND	6	MDSR4-
7	MRTS4-	8	MCTS4-
9	MRI4 -	10	--

Connecting External Serial Ports

Your COM port may come mounted on a card-edge bracket. Install the card-edge bracket to an available slot at the rear of the system chassis then insert the serial port cable to the COM connector. Make sure the colored stripe on the ribbon cable is aligned with pin 1 of the COM connector.

COM5

Pin	Function	Pin	Function
1	MDCD5-	2	MSIN5-
3	MSO5-	4	MDTR5-
5	GND	6	MDSR5-
7	MRTS5-	8	MCTS5-
9	MRI5 -	10	--

COM6

Pin	Function	Pin	Function
1	MDCD6-	2	MSIN6-
3	MSO6-	4	MDTR6-
5	GND	6	MDSR6-
7	MRTS6-	8	MCTS6-
9	MRI6 -	10	--

Internal I/O Connectors

Cooling Fan Connectors

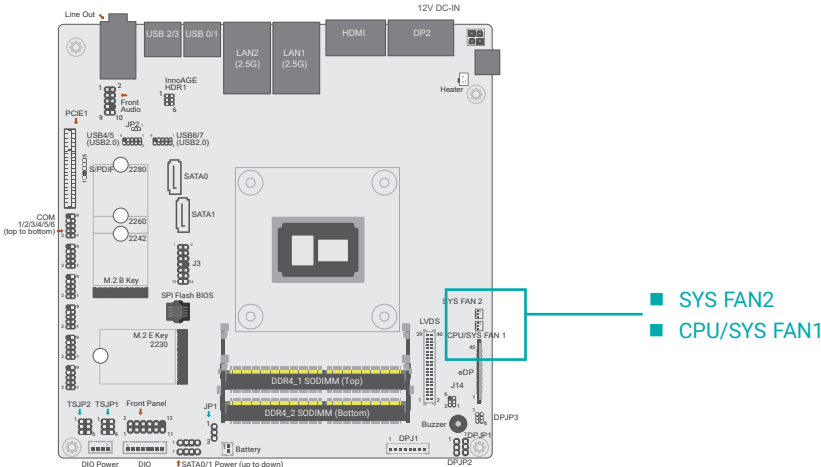

These fan connectors are used to connect cooling fans. The cooling fans will provide adequate airflow throughout the chassis to prevent overheating the CPU and system board components.

Pin	Function
1	GND
2	PWM
3	TACH

Internal I/O Connectors

InnoAGE HDR1

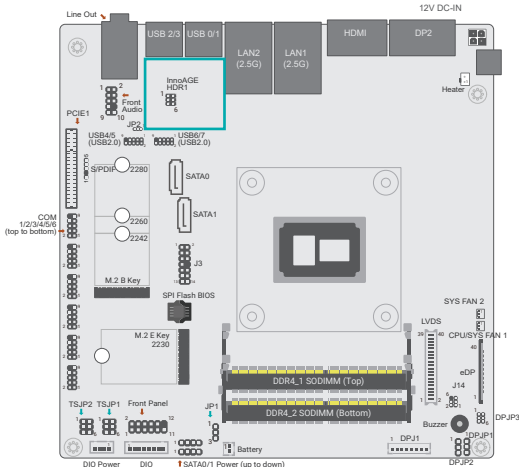

Pin	Function	Pin	Function
1	PM_SYSRST#	2	GP_G14_RECOV#
3	SUS_LED#	4	HD_LED#
5	SIO_PWSIN#	6	GND

Internal I/O Connectors

Front Panel

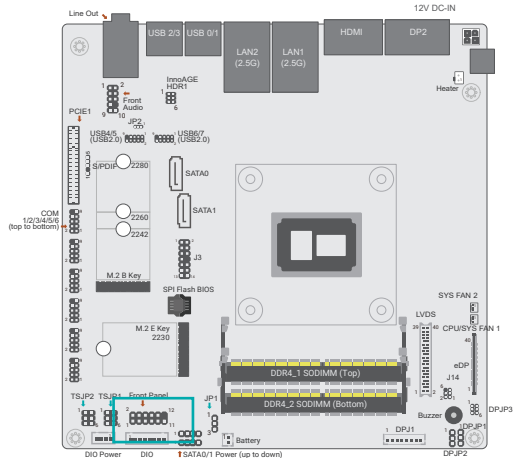

Pin	Function	Pin	Function
1	N.C.	2	3V3SB
3	3V3	4	3V3SB
5	HD_LED#	6	SUS_LED#
7	GND	8	GND
9	PM_SYSRST#	10	SIO_PWSIN#
11	N.C.	12	--

HDD LED - Hard Disk Drive LED

Lighting of the LED indicates that the hard drive is being accessed.

RESET - Reset Switch

This switch allows you to reboot without having to power off the system.

Power/Standby LED

When the system's power is on, this LED will light up. When the system is in the S1 (POS - Power On Suspend) state, it will blink at 1-second intervals. When the system is in the S3 (STR - Suspend To RAM) state, it will blink at 4-second intervals.

Power Button

This button is used to switch the system's power on or off .

Internal I/O Connectors

S/PDIF Connector

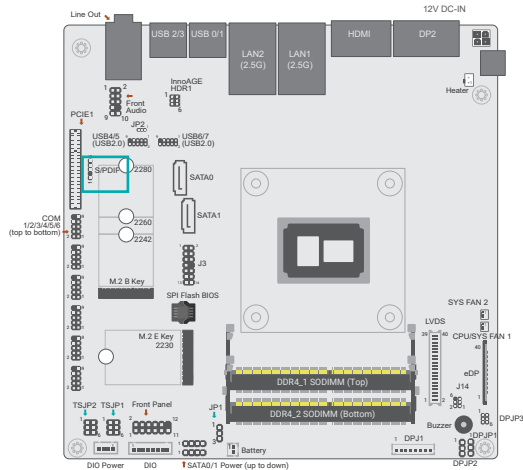

The S/PDIF connector is used to connect an external S/PDIF port. Your S/PDIF port may be mounted on a card-edge bracket. Install the card-edge bracket to an available slot at the rear of the system chassis then connect the audio cable to the S/PDIF connector. Make sure pin 1 of the audio cable is aligned with pin 1 of the S/PDIF connector.

Pin	Function
1	A5V
2	--
3	SPOUT
4	GND
5	SPIN

Internal I/O Connectors

Expansion Slots

- A PCIe 1 (PCIe x4 with x2 Signal)
- B M.2 B KEY
- C M.2 E KEY
- D SIM Card Slot

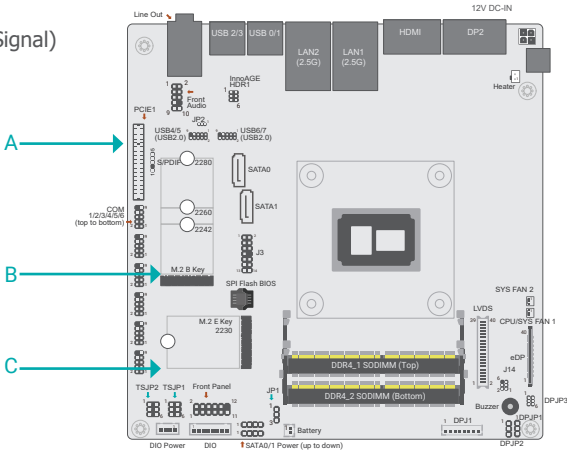

PCI Express x4 Slot

Install PCI Express cards such as network cards or other expansion cards.

M.2 Socket

The M.2 socket is the Next Generation Form Factor (NGFF) which is designed to support multiple modules and make the M.2 more suitable in application for solid-state storage.

SIM Card Slot

For SIM card usage.

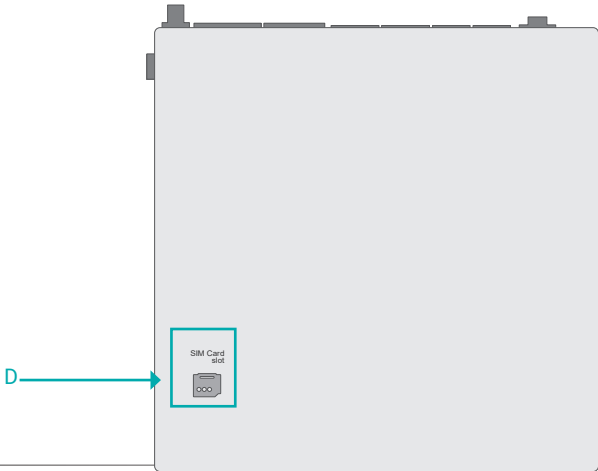

Internal I/O Connectors > Expansion Slots

Installing the M.2 Module

Before installing the M.2 module into the M.2 socket, please make sure that the following safety cautions are well-attended.

1. Make sure the PC and all other peripheral devices connected to it has been powered down.
2. Disconnect all power cords and cables.
3. Locate the M.2 socket on the system board
4. Make sure the notch on card is aligned to the key on the socket.
5. Make sure the standoff screw is removed from the standoff.

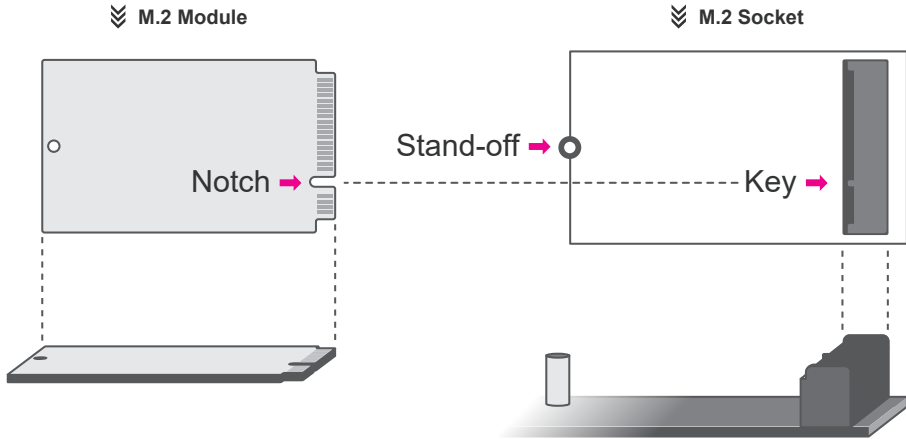

Internal I/O Connectors Expansion Slots

Please follow the steps below to install the card into the socket.

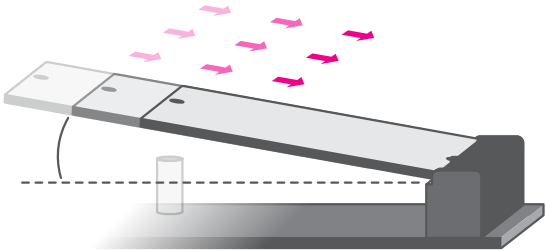

Step 1: Insert the card into the socket at an angle while making sure the notch and key are perfectly aligned.

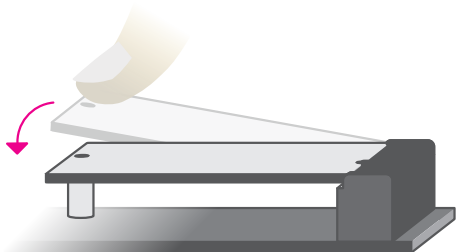

Step 2: Press the end of the card far from the socket down until the gap between the card and the stand-off closes up.



Step 3: Screw tight the card onto the stand-off with a screw driver and a stand-off screw until the gap between the card and the stand-off closes up. The card should be lying parallel to the board when it's correctly mounted.

Internal I/O Connectors

Battery Header

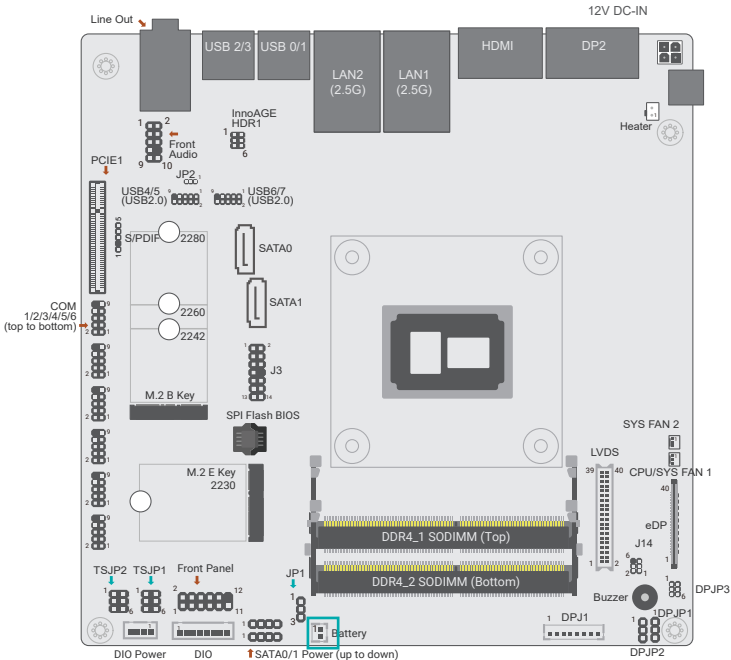

The lithium ion battery addendum supplies power to the real-time clock and CMOS memory as an auxiliary source of power when the main power is shut off. Plug the battery cable into the header.

Pin	Function	Pin	Function
1	V_BAT	2	GND

Safety Measures

- There exists explosion hazard if the battery is incorrectly installed.
- Replace only with the same or equivalent type recommended by the manufacturer.
- Dispose of used batteries according to local ordinances.

► **Internal I/O Connectors**

DIO Power

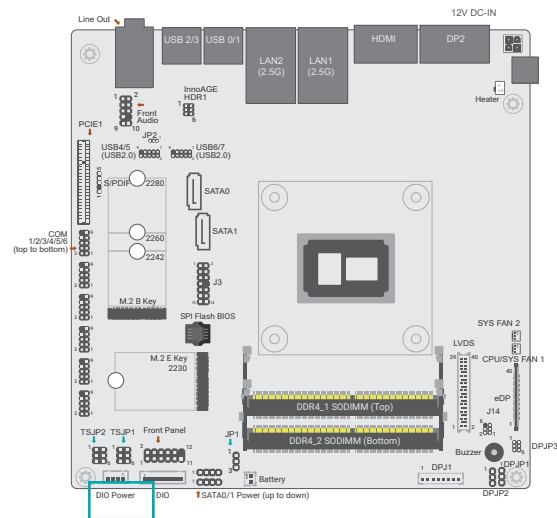

Pin	Function
1	+12V
2	GND
3	5VSB
4	5V

► **Internal I/O Connectors**

LVDS Backlight

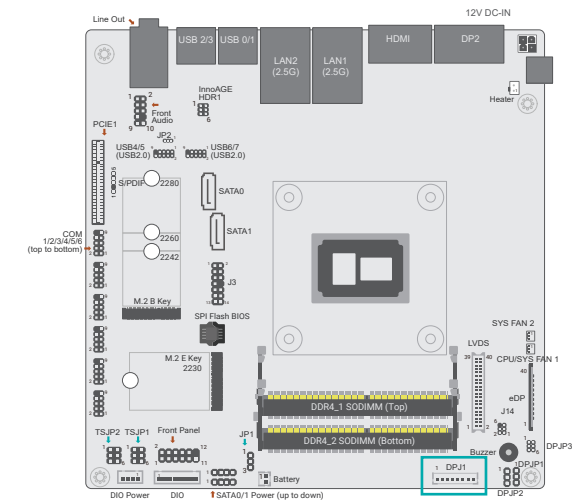

LVDS Backlight (DPJ1)

Pin	Function
1	GND
2	GND
3	DIMMING
4	GND
5	LVDS_3V3
6	BLONOFF
7	INV_PWR
8	INV_PWR

Chapter 3 - BIOS Settings

► Overview

The BIOS is a program that takes care of the basic level of communication between the CPU and peripherals. It contains codes for various advanced features found in this system board.

The BIOS allows you to configure the system and save the configuration in a battery-backed CMOS so that the data retains even when the power is off. In general, the information stored in the CMOS RAM of the EEPROM will stay unchanged unless a configuration change has been made such as a hard drive replaced or a device added.

It is possible that the CMOS battery will fail causing CMOS data loss. If this happens, you need to install a new CMOS battery and reconfigure the BIOS settings.



Note:

The BIOS is constantly updated to improve the performance of the system board; therefore the BIOS screens in this chapter may not appear the same as the actual one. These screens are for reference purpose only.

Default Configuration

Most of the configuration settings are either predefined according to the Load Optimal Defaults settings which are stored in the BIOS or are automatically detected and configured without requiring any actions. There are a few settings that you may need to change depending on your system configuration.

Entering the BIOS Setup Utility

The BIOS Setup Utility can only be operated from the keyboard and all commands are keyboard commands. The commands are available at the right side of each setup screen.

The BIOS Setup Utility does not require an operating system to run. After you power up the system, the BIOS message appears on the screen and the memory count begins. After the memory test, the message "Press DEL to run setup" will appear on the screen. If the message disappears before you respond, restart the system or press the "Reset" button. You may also restart the system by pressing the <Ctrl> <Alt> and keys simultaneously.

Legends

Keys	Function
Right / Left arrow	Move the highlight left or right to select a menu
Up / Down arrow	Move the highlight up or down between submenus or fields
<Enter>	Enter the highlighted submenu
+ (plus key)/F6	Scroll forward through the values or options of the highlighted field
- (minus key)/F5	Scroll backward through the values or options of the highlighted field
<F1>	Display general help
<F2>	Display previous values
<F9>	Optimized defaults
<F10>	Save and Exit
<Esc>	Return to previous menu

Scroll Bar

When a scroll bar appears to the right of the setup screen, it indicates that there are more available fields not shown on the screen. Use the up and down arrow keys to scroll through all the available fields.

Submenu

When "►" appears on the left of a particular field, it indicates that a submenu which contains additional options are available for that field. To display the submenu, move the highlight to that field and press <Enter>.

► Main

The Main menu is the first screen that you will see when you enter the BIOS Setup Utility.

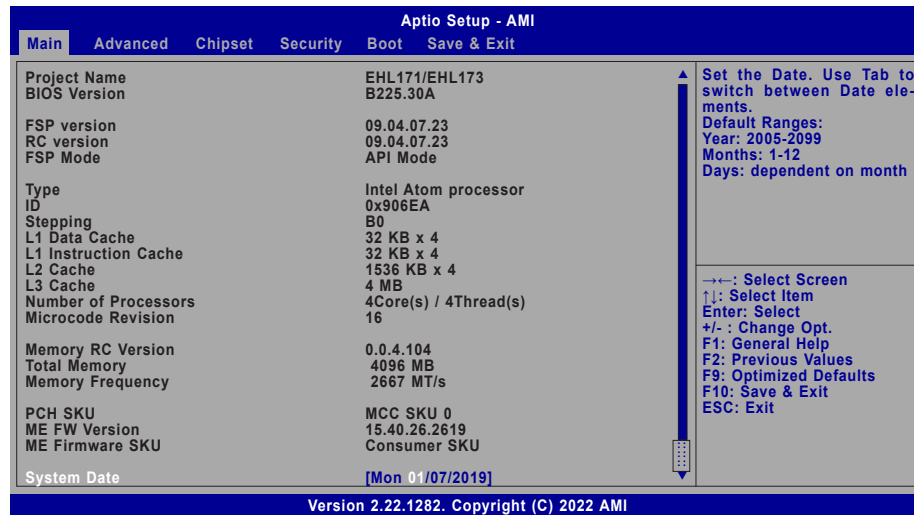

System Date

The date format is <month>, <date>, <year>. Press "Tab" to switch to the next field and press "-" or "+" to modify the value.

System Time

The time format is <hour>, <minute>, <second>. The time is based on the 24-hour military-time clock. For example, 1 p.m. is 13:00:00. Hour displays hours from 00 to 23. Minute displays minutes from 00 to 59. Second displays seconds from 00 to 59.

► Advanced

The Advanced menu allows you to configure your system for basic operation. Some entries are defaults required by the system board, while others, if enabled, will improve the performance of your system or let you set some features according to your preference.



Important:
Setting incorrect field values may cause the system to malfunction.

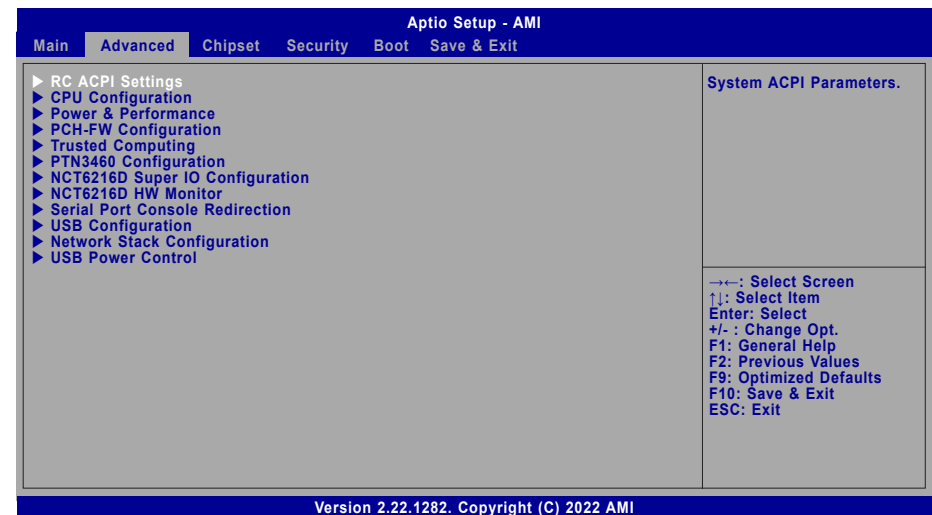

► Advanced

RC ACPI Configuration

Aptio Setup - AMI		
Advanced		
RC ACPI Configuration		Enable or disable System wake on alarm event. When enabled, System will wake on the hr:min::sec specified
Wake system from S5 via RTC	[Enabled]	
Wake up hour	0	→←: Select Screen ↑↓: Select Item Enter: Select +/-: Change Opt. F1: General Help F2: Previous Values F9: Optimized Defaults F10: Save & Exit ESC: Exit
Wake up minute	0	
Wake up second	0	
State After G3	[S0 State]	
Version 2.22.1282. Copyright (C) 2022 AMI		

Wake system from S5

When Enabled, the system will automatically power up at a designated time every day. Once it's switched to [Enabled], please set up the time of day — hour, minute, and second — for the system to wake up.

State After G3

This field is to specify what state the system should be in when power is re-applied after a power failure (G3, the mechanical-off, state).

► Advanced

CPU Configuration

Aptio Setup - AMI			
Advanced			
CPU Configuration		When enabled, a VMM can utilize the additional hardware capabilities provided by Vanderpool Technology.	
Intel (VMX) Virtualization Technology	[Enable]		
Active Processor Cores	[All]	→←: Select Screen ↑↓: Select Item Enter: Select +/-: Change Opt. F1: General Help F2: Previous Values F9: Optimized Defaults F10: Save & Exit ESC: Exit	
Version 2.22.1282. Copyright (C) 2022 AMI			

Intel (VMX) Virtualization Technology

When this field is set to Enabled, the VMM can utilize the additional hardware capabilities provided by Vanderpool Technology.

Active Processor Cores

Select number of cores to enable in each processor package.



Note:

Some of the fields may not be available when the features are not supported by the equipped CPU.

► Advanced

Power & Performance

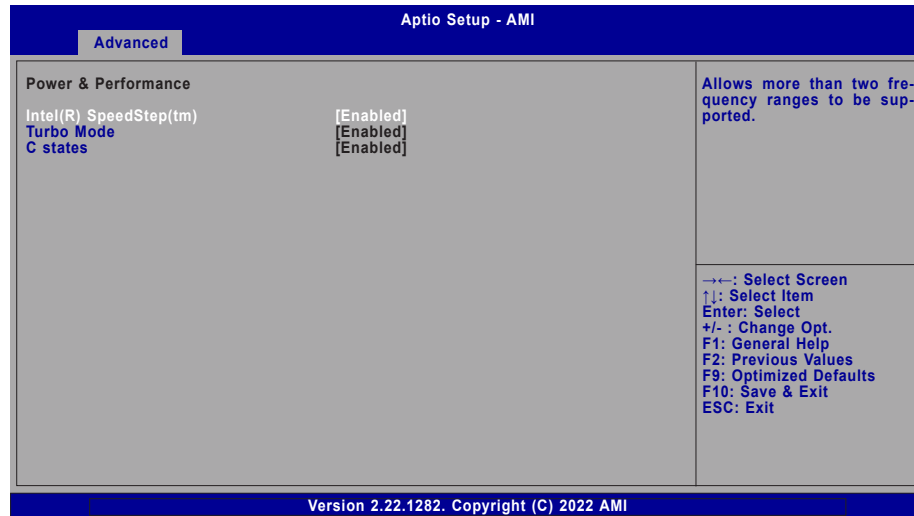

Intel(R) SpeedStep(tm)

This field is used to enable or disable the Intel SpeedStep® Technology, which helps optimize the balance between system's power consumption and performance. After it is enabled in the BIOS, EIST features can then be enabled via the operating system's power management.

Turbo Mode

Enable or disable turbo mode of the processor. This field will only be displayed when EIST is enabled.

C states

Enable or disable CPU Power Management. It allows CPU to enter "C states" when it's idle and nothing is executing.

► Advanced

PCH-FW Configuration

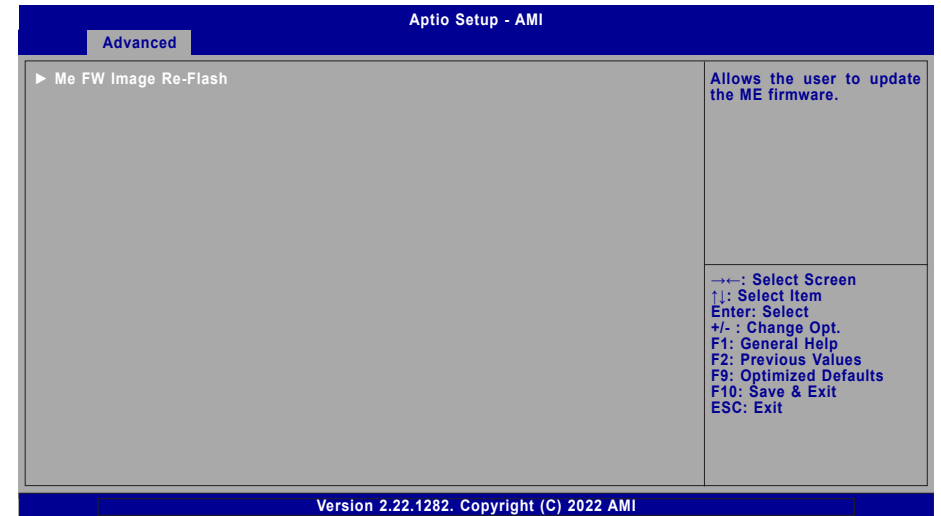

Me FW Image Re-Flash

This field is used to enable or disable the ME FW Image Re-Flash function, which allows the user to update the ME firmware.

► Advanced

Trusted Computing

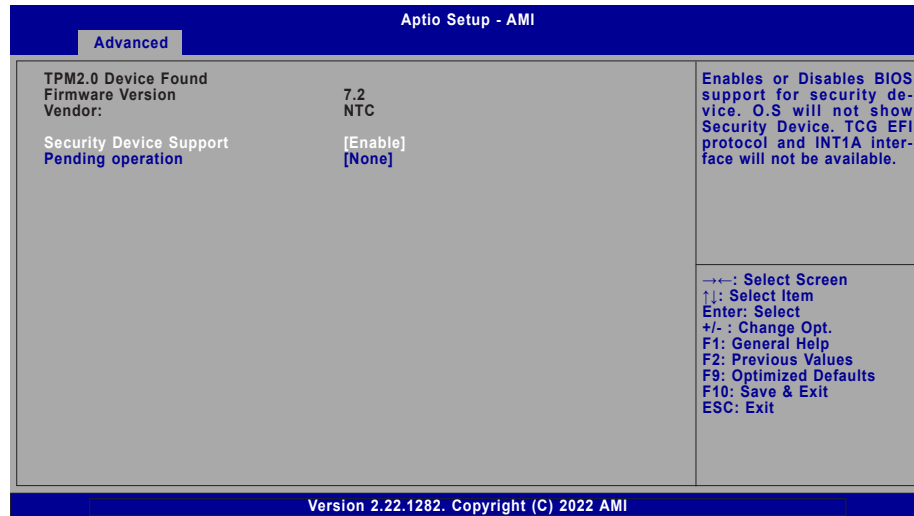

Security Device Support

This field is used to enable or disable BIOS support for the security device such as an TPM 2.0 to achieve hardware-level security via cryptographic keys.

Pending operation

To clear the existing TPM encryption, select "TPM Clear" and restart the system. This field is not available when "Security Device Support" is disabled.

► Advanced

PTN3460 Configuration

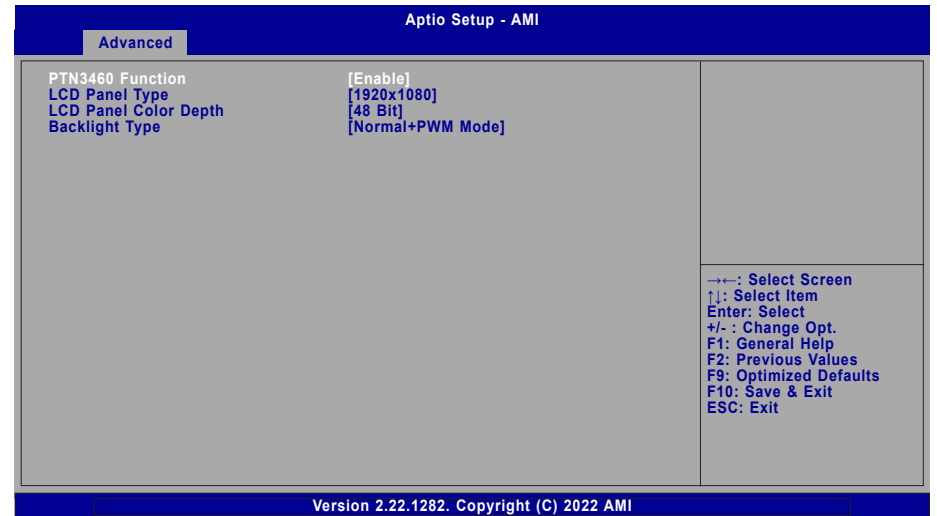

PTN3460 Function

Enable or Disable PTN3460 LCD Features. When this field is disabled, the following fields will remain hidden.

LCD Panel Type

Select the resolution of the LCD Panel – 800X480, 800X600, 1024X768, 1366X768, 1280X1024, 1920X1080, or 1920X1200.

LCD Panel Color Depth

Select the color depth of the LCD Panel – 18 Bit, 24 Bit, 36 Bit, 48 Bit.

Backlight Type

Select the backlight type of the LCD Panel –
 Normal + PWM
 Normal + DC



Note:

The configuration must match the specifications of your LCD Panel in order for the LCD Panel to display properly.

▶ **Advanced**

NCT6126D Super IO Configuration

Aptio Setup - AMI	
Advanced	
NCT6126D Super IO Configuration	
Super IO Chip	NCT6126D
WatchDog Timer Unit	[Second]
SuperIO WatchDog Timer	0
<ul style="list-style-type: none"> ▶ Serial Port 1 Configuration ▶ Serial Port 2 Configuration ▶ Serial Port 3 Configuration ▶ Serial Port 4 Configuration ▶ Serial Port 5 Configuration ▶ Serial Port 6 Configuration 	WatchDog Timer Unit Selection →←: Select Screen ↑↓: Select Item Enter: Select +/- : Change Opt. F1: General Help F2: Previous Values F9: Optimized Defaults F10: Save & Exit ESC: Exit
Version 2.22.1282. Copyright (C) 2022 AMI	

WatchDog Timer Unit

Select WatchDog Timer Unit – Second or Minute.

SuperIO WatchDog Timer

Set SuperIO WatchDog Timer Timeout value. The range is from 0 (disabled) to 255.



Note:

The sub-menus are detailed in following sections.

▶ **Advanced** ▶ **NCT6126D Super IO Configuration**

▶ **Serial Port Configuration**

Aptio Setup - AMI	
Advanced	
Serial Port 1 Configuration	
Serial Port	[Enabled]
Device Settings	IO=3F8h; IRQ=4;
Electrical Interface Mode	[RS232]
	Enable or Disable Serial Port (COM)
	→←: Select Screen ↑↓: Select Item Enter: Select +/- : Change Opt. F1: General Help F2: Previous Values F9: Optimized Defaults F10: Save & Exit ESC: Exit
Version 2.22.1282. Copyright (C) 2022 AMI	

Serial Port

Enable or disable the current serial COM port.

Electrical Interface Mode

Choose mode between RS232 / RS485 / RS422

► **Advanced**

NCT6126D HW Monitor

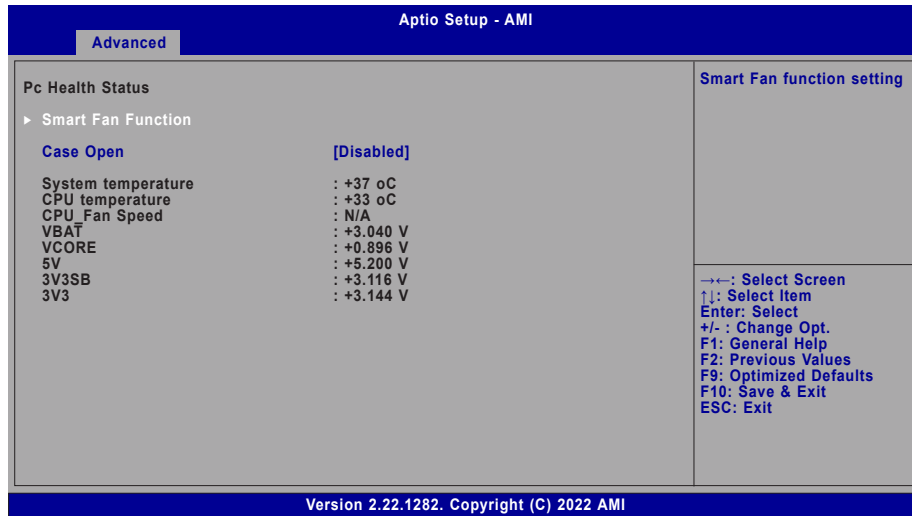

Case Open

Enable or disable system intrusion detection.

► **Advanced** ► **NCT6126D HW Monitor**

► **Smart Fan Function**

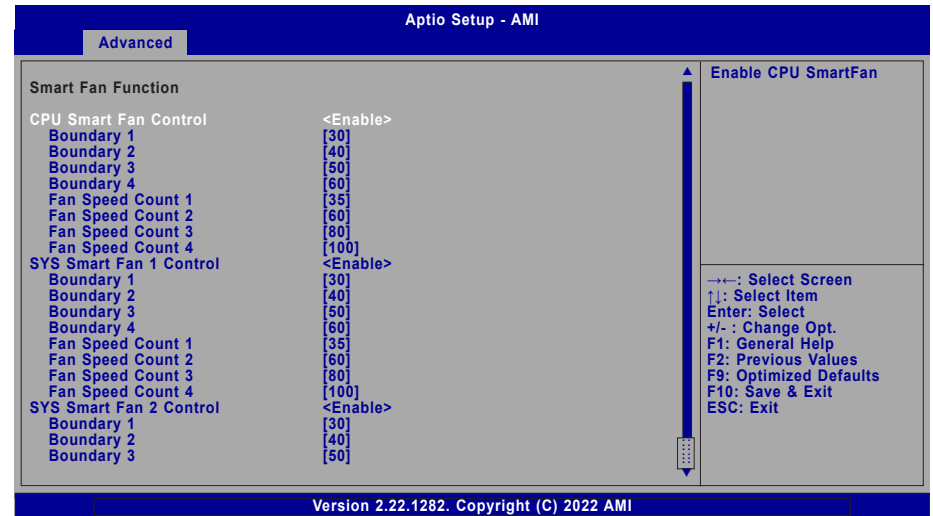

Smart Fan is a fan speed moderation strategy dependent on the current system temperature. When the system temperature goes higher than the Boundary setting, the fan speed will be turned up to the setting of the Fan Speed Count that bears the same index as the Boundary field.

▼ **SYS Smart Fan/CPU Smart Fan Control = [Enabled]**

Boundary 1 to Boundary 4

Set the boundary temperatures that determine the fan speeds accordingly, the value ranging from 0-127°. For example, when the system temperature reaches Boundary 1 setting, the fan speed will be turned up to the designated speed of the Fan Speed Count 1 field.

Fan Speed Count 1 to Fan Speed Count 4

Set the fan speed, the value ranging from 1-100%, 100% being full speed. The fans will operate according to the specified boundary temperatures above-mentioned.

▼ **SYS Smart Fan/CPU Smart Fan Control = [Disabled]**

Fix Fan Speed Count

Set the fan speed, the value ranging from 1-100%, 100% being full speed. The fans will always operate at the specified speed regardless of gauged temperatures.

► **Advanced**

Serial Port Console Redirection

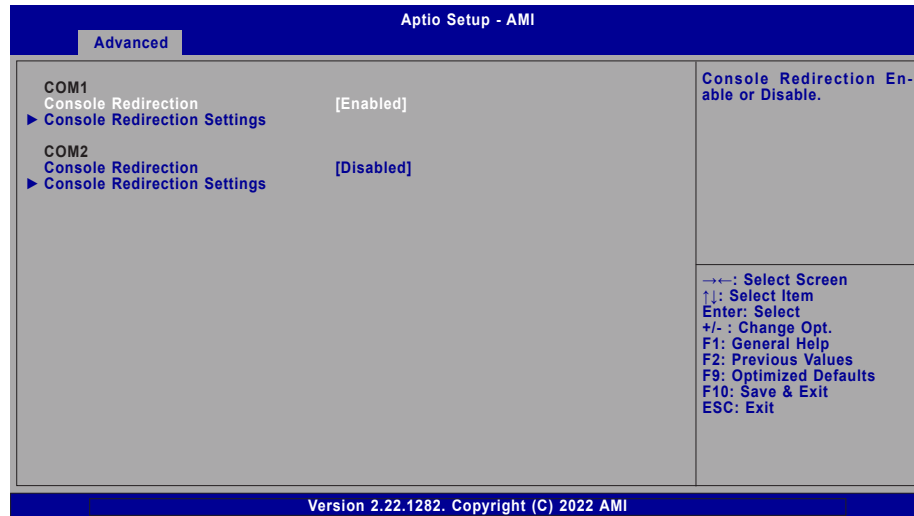

Console Redirection

By enabling Console Redirection of a COM port, the sub-menu of console redirection settings will become available for configuration as detailed in the following.

► **Advanced** ► **Serial Port Console Redirection**

► **Console Redirection Settings**

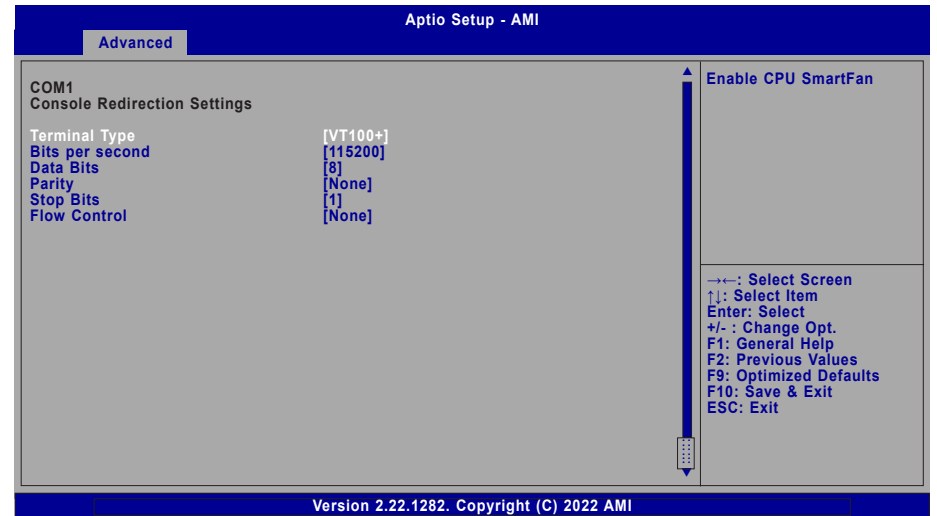

Configure the serial settings of the current COM port.

Terminal Type

Select terminal type: VT100, VT100+, VT-UTF8 or ANSI.

Bits per second

Select serial port transmission speed: 9600, 19200, 38400, 57600 or 115200.

Data Bits

Select data bits: 7 bits or 8 bits.

Parity

Select parity bits: None, Even, Odd, Mark or Space.

Stop Bits

Select stop bits: 1 bit or 2 bits.

Flow Control

Select flow control type: None or Hardware RTS/CTS.

► **Advanced**

USB Configuration

Aptio Setup - AMI	
Advanced	
USB Configuration	
XHCI Hand-off	[Enabled]
USB Mass Storage Driver Support	[Enabled]
Enables Legacy USB support. AUTO option disables legacy support if no USB devices are connected. DISABLE option will keep USB devices available only for EFI applications.	
→←: Select Screen ↑↓: Select Item Enter: Select +/- : Change Opt. F1: General Help F2: Previous Values F9: Optimized Defaults F10: Save & Exit ESC: Exit	
Version 2.22.1282. Copyright (C) 2022 AMI	

XHCI Hand-off

Enable or disable XHCI Hand-off.

USB Mass Storage Driver Support

Enable or disable USB Mass Storage Driver Support.

► **Advanced**

Network Stack Configuration

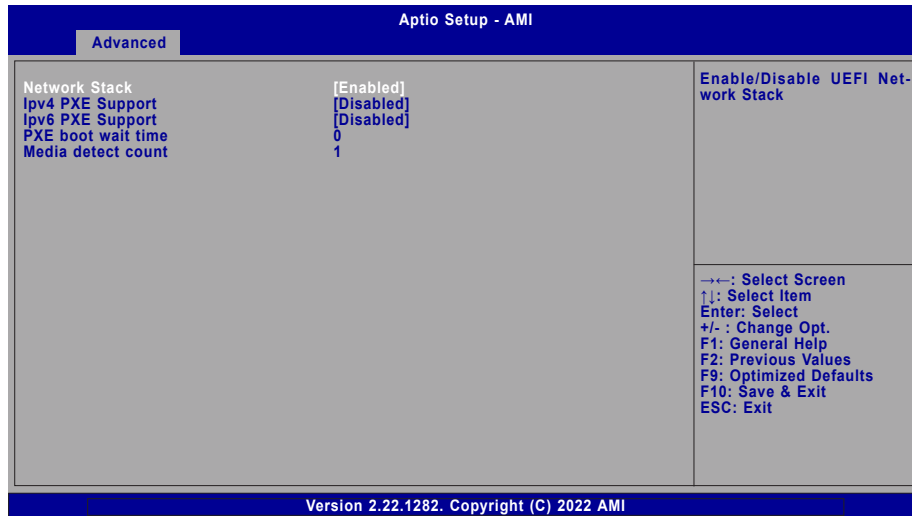

Network Stack

Enable or disable UEFI network stack. The following fields will appear when this field is enabled.

Ipv4 PXE Support

Enable or disable IPv4 PXE boot support. If disabled, IPv4 PXE boot support will not be available.

Ipv6 PXE Support

Enable or disable IPv6 PXE boot support. If disabled, IPv6 PXE boot support will not be available.

PXE boot wait time

Set the wait time in seconds to press ESC key to abort the PXE boot. Use either +/- or numeric keys to set the value.

Media detect count

Set the number of times the presence of media will be checked. Use either +/- or numeric keys to set the value.

► **Advanced**

USB Power Control

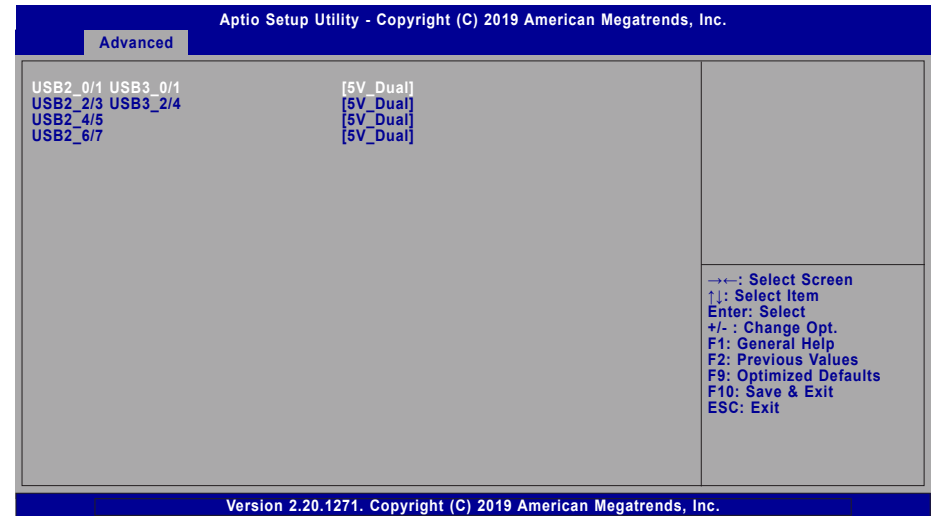

5V / 5V_DUAL

5V Dual supports wake up from S3/S4 state by USB keyboard or mouse while 5V does not.

► Chipset

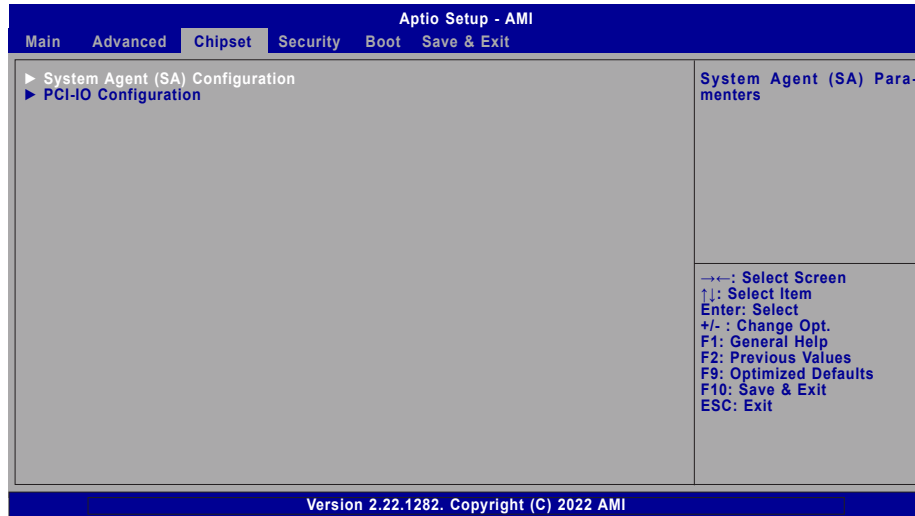

► Chipset ► System Agent(SA) Configuration ► Memory Configuration

Memory Configuration

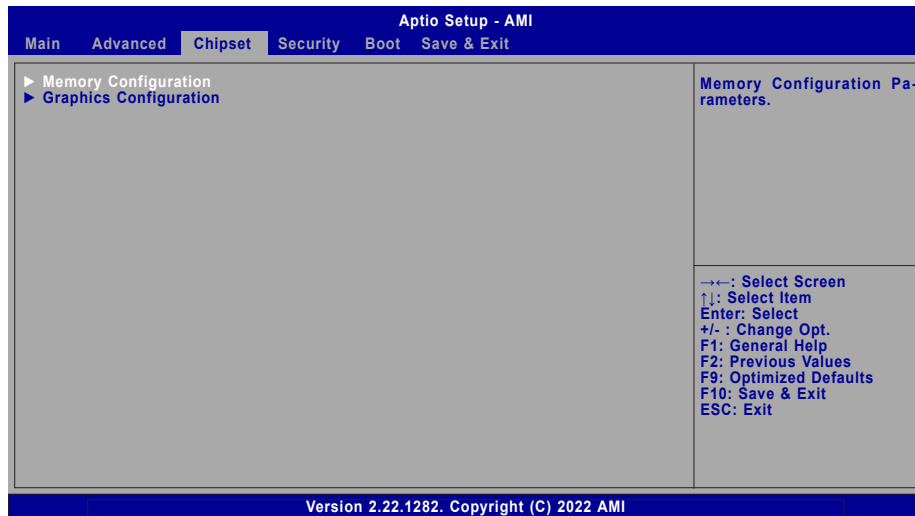
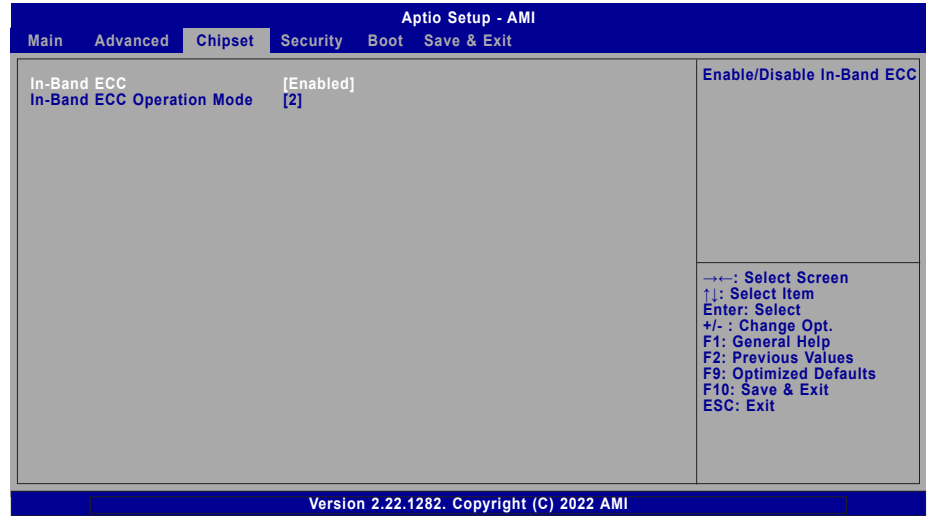

In-Band ECC

Enable or disable In-Band ECC.

In-Band Operation Mode

- 0: Functional Mode protects requests based on the address range.
- 1: Makes all requests none protected and ignore range checks.
- 2: Makes all requests protected and ignore range checks.

► **Chipset** ► **System Agent(SA) Configuration** ► **Graphics Configuration**

Graphics Configuration

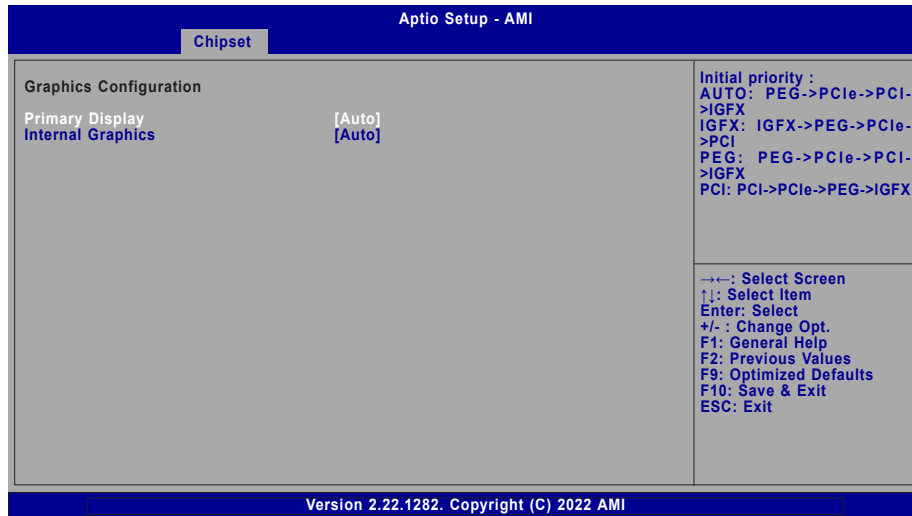

Primary Display

Select which of IGFX/PEG/PCI Graphics device to be the primary display.

Internal Graphics

Keep IGFX enabled based on the setup options.

► Chipset ► PCH-IO Configuration

PCH-IO Configuration

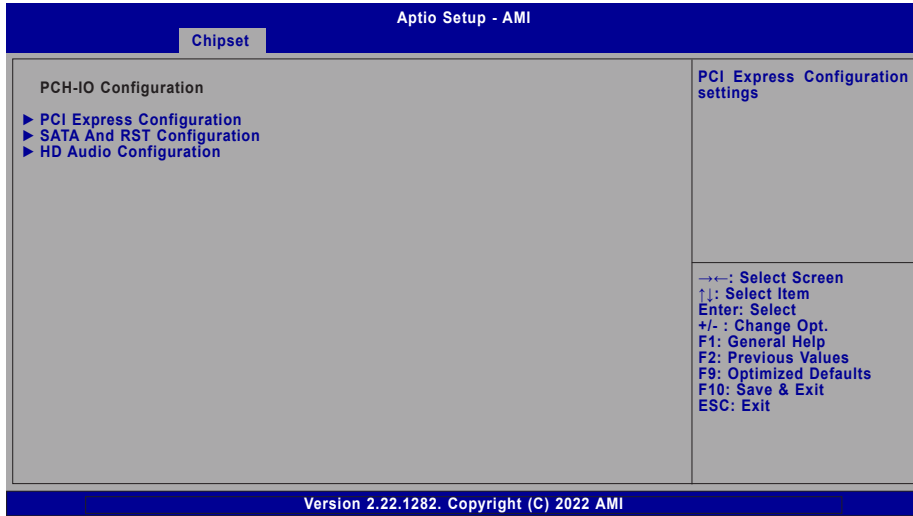

► Chipset ► PCH-IO Configuration ► PCI Express Configuration

PCI Express Configuration

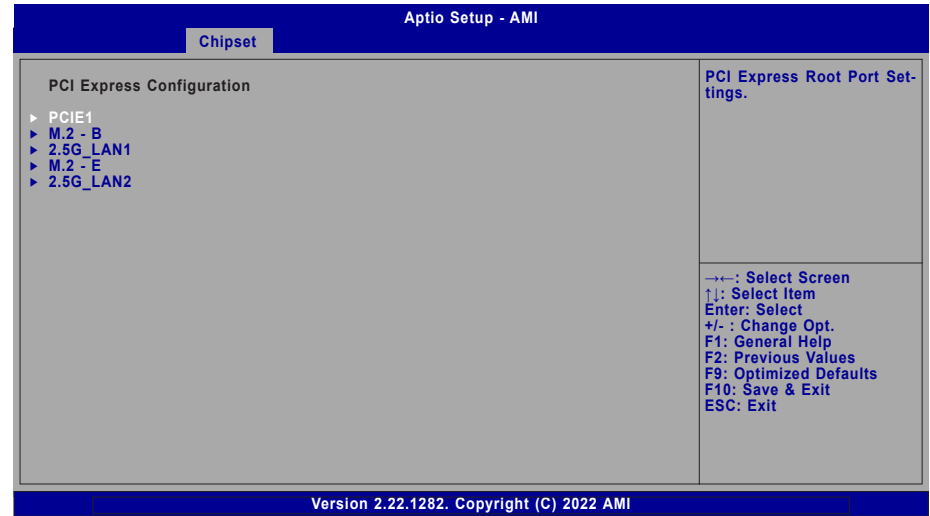

Note:
 The sub-menus are detailed in following sections.

Select one of the PCI Express channels and press enter to configure the following settings.

PCI Express Devices

Enable or disable the PCI Express Root Port.

PCIe Speed

Select PCIe Speed of the current port – AUTO, Gen1, Gen 2, or Gen3. Gen 3 is only available for the PCIE1 port. This field may not appear when the speed of the port is not configurable.

► Chipset ► PCH-IO Configuration ► SATA And RST Configuration

SATA And RST Configuration

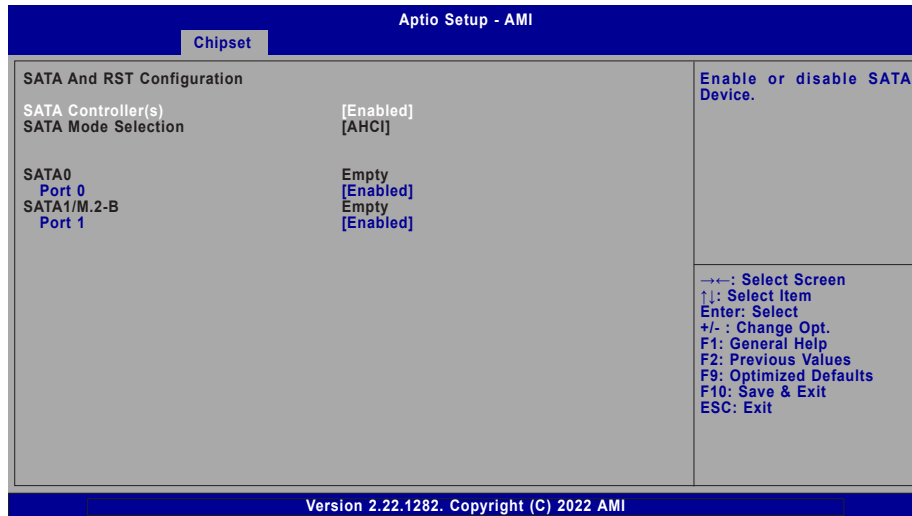

SATA Controller(s)

This field is used to enable or disable the Serial ATA controller.

SATA Mode Selection

The mode selection determines how the SATA controller(s) operates.

- **AHCI** This option allows the Serial ATA controller(s) to use AHCI (Advanced Host Controller Interface).

► Chipset ► PCH-IO Configuration ► HD Audio Configuration

HD Audio Configuration

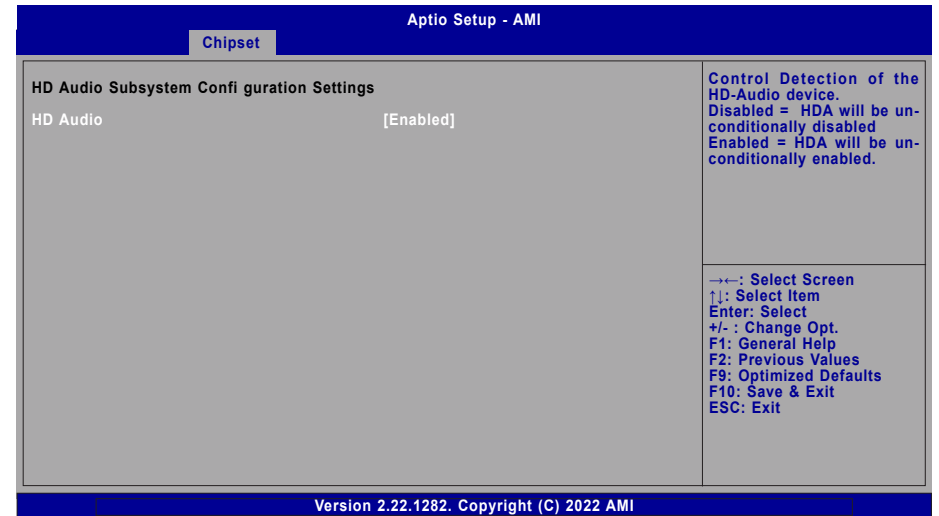

HD Audio

Control the detection of the HD Audio device.

- **Disabled** HDA will be unconditionally disabled.
- **Enabled** HDA will be unconditionally enabled.

► Security

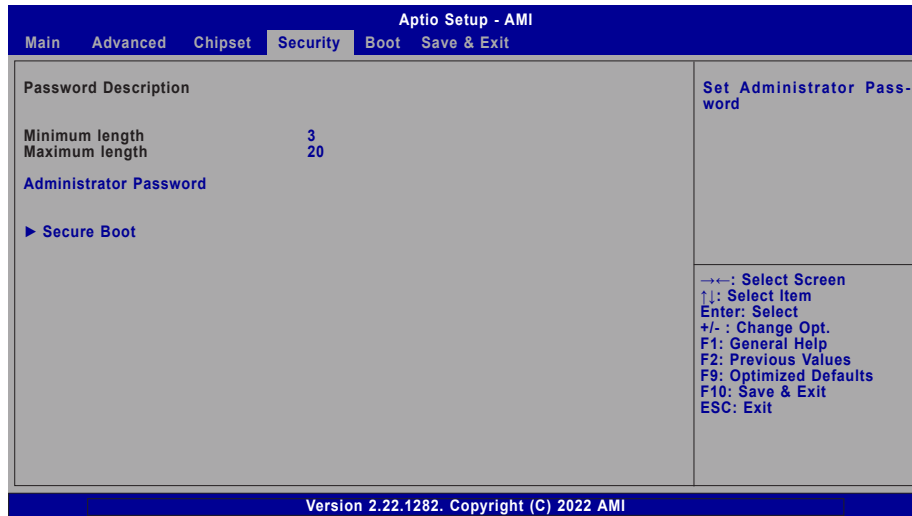

Administrator Password

Set the administrator password. To clear the password, input nothing and press enter when a new password is asked. Administrator Password will be required when entering the BIOS.

► Security

Secure Boot

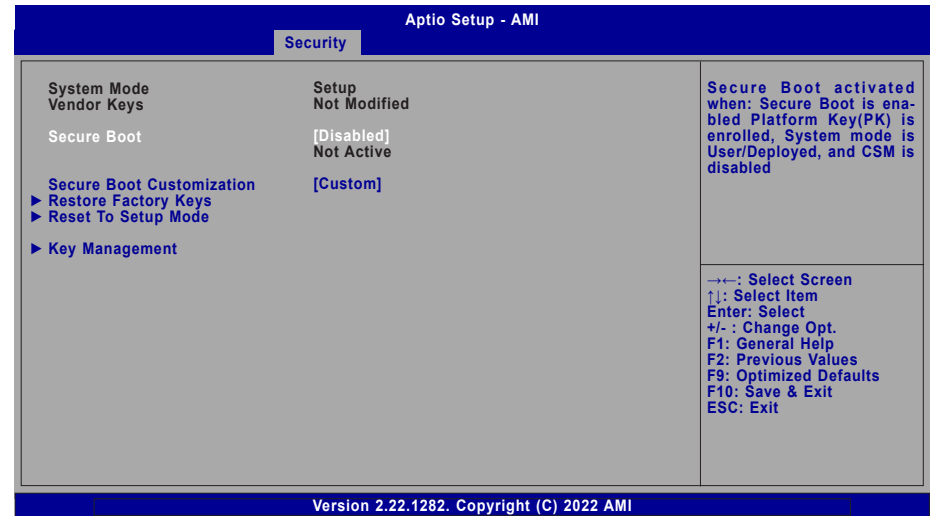

Secure Boot

The Secure Boot store a database of certificates in the firmware and only allows the OSeS with authorized signatures to boot on the system. To activate Secure Boot, please make sure that “Secure Boot” is “[Enabled]”, Platform Key (PK) is enrolled, “System Mode” is “User”, and CSM is disabled. After enabling/disabling Secure Boot, please save the configuration and restart the system. When configured and activated correctly, the Secure Boot status will be “Active”.

Secure Boot Customization

Select the secure boot mode – Standard or Custom. When set to Custom, the following fields will be configurable for the user to manually modify the key database.

Restore Factory Keys

Force system to User Mode. Load OEM-defined factory defaults of keys and databases onto the Secure Boot. Press Enter and a prompt will show up for you to confirm.

Reset To Setup Mode

Clear the database from the NVRAM, including all the keys and signatures installed in the Key Management menu. Press Enter and a prompt will show up for you to confirm.

► Key Management

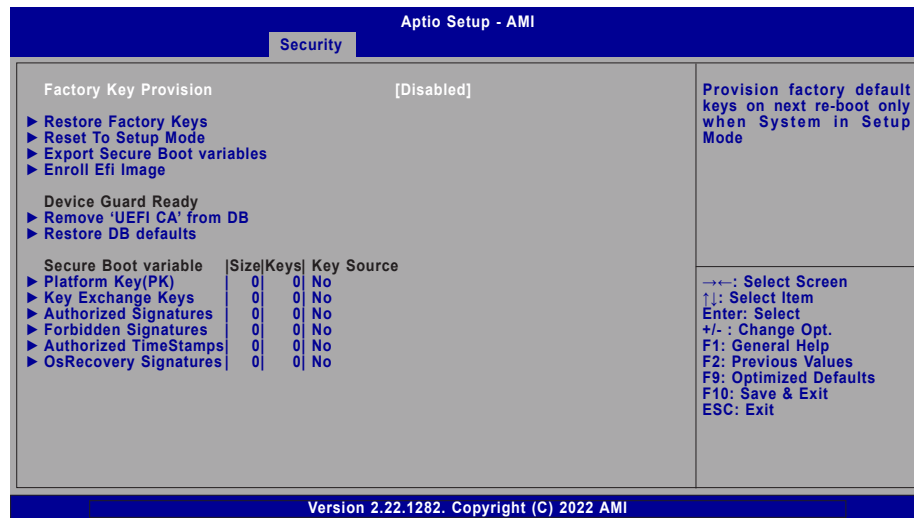

Factory Key Provision

Enable or disable the provision factory default keys on next re-start. This will only take place when the “System Mode” in the previous menu is in “Setup”, which can be achieved by moving the cursor to the “Reset To Setup Mode” and press Enter.

Restore Factory Keys

Force system to User Mode. Configure NVRAM to contain OEM-defined factory default Secure Boot keys.

Reset To Setup Mode

Clear the database from the NVRAM, including all the keys and signatures installed in the Key Management menu. Press Enter and a prompt will show up for you to confirm.

Export Secure Boot variables

Export the Secure Boot settings (i.e. all keys and signatures) as files to the root directory of a file system device. Press Enter and select a storage device listed in the pop-up menu. The saved files will be named automatically according to the type of key/signature as listed below.

- “PK” for Platform Keys
- “KEK” for Key Exchange Keys
- “db” for Authorized Signatures
- “dbx” for Forbidden Signatures

Enroll Efi Image

Allow the image to run in Secure Boot mode. Enroll SHA256 Hash certificate of a PE image into Authorized Signature Database (db). Press Enter and select a storage device listed in the pop-up menu, select a directory, and then select the EFI Image document.

Remove ‘UEFI CA’ from DB

Remove Microsoft UEFI CA from the Authorized Signature database. For systems that support Device Guard, Microsoft UEFI CA must NOT be included in the Authorized Signature database.

Restore DB defaults

Press Enter to restore the database variable to factory defaults.

Manually configure the following keys and signatures. Move the cursor to the field and press Enter, and then a pop-up menu will show up.

Platform Key(PK), Key Exchange Keys, Authorized Signatures, Forbidden Signatures, Authorized TimeStamps, OsRecovery Signatures

- **Details** List the information of enrolled keys and signatures
- **Export** Save the key or signature as a file to the root directory of a file system. The saved files will be named automatically according to the type of key/signature as previously listed in the “Export Secure Boot Variables”.
- **Update** Load factory default database
- **Append** Enroll keys and signatures from a file system
- **Delete** Delet keys and signatures

► **Boot**

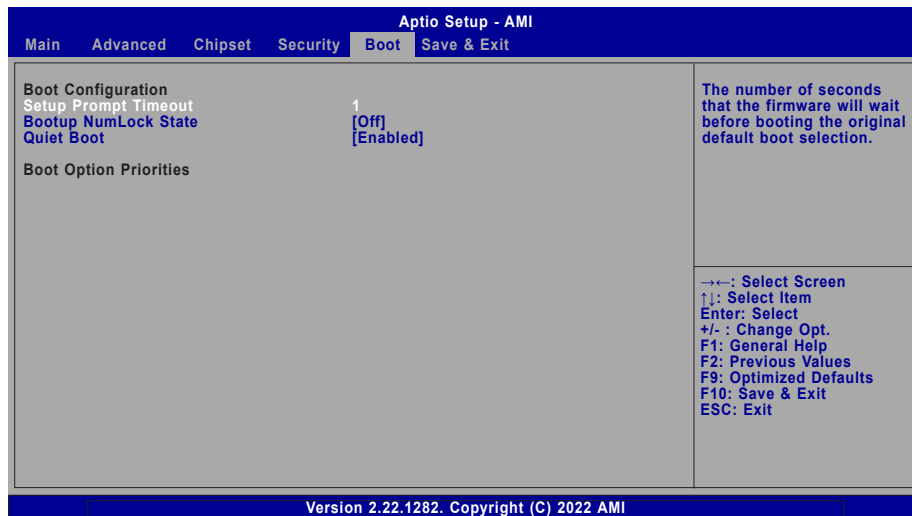

Setup Prompt Timeout

Set the number of seconds to wait for the setup activation key. 65535 (0xFFFF) denotes indefinite waiting.

Bootup NumLock State

Select the keyboard NumLock state: On or Off.

Quiet Boot

This section is used to enable or disable quiet boot option.

Boot Option Priorities

Rearrange the system boot order of available boot devices.

► **Save & Exit**

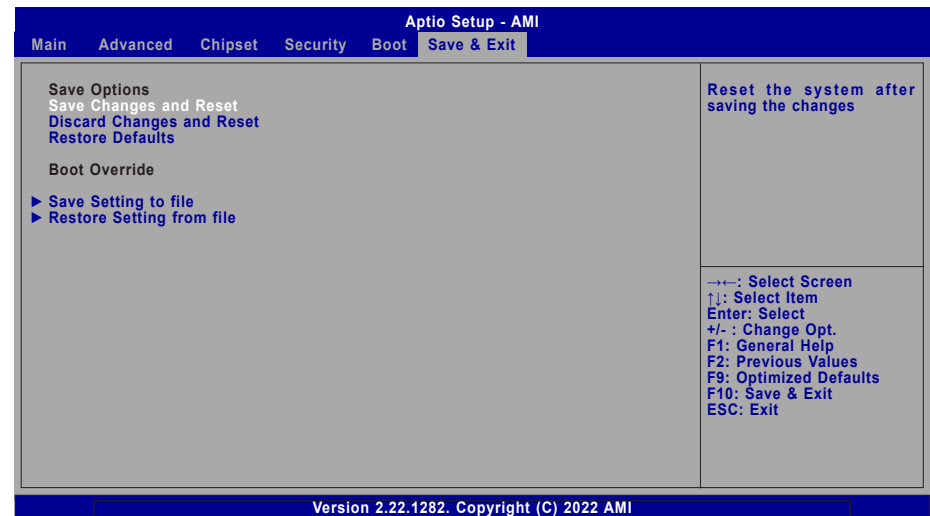

Save Changes and Reset

To save the changes, select this field and then press <Enter>. A dialog box will appear. Select Yes to reset the system after saving all changes made.

Discard Changes and Reset

To discard the changes, select this field and then press <Enter>. A dialog box will appear. Select Yes to reset the system setup without saving any changes.

Restore Defaults

To restore and load the optimized default values, select this field and then press <Enter>. A dialog box will appear. Select Yes to restore the default values of all the setup options.

Boot Override

Move the cursor to an available boot device and press Enter, and then the system will immediately boot from the selected boot device. The Boot Override function will only be effective for the current boot. The "Boot Option Priorities" configured in the Boot menu will not be changed.

► **Save Setting to file**

Select this option to save BIOS configuration settings to a USB flash device.

► **Restore Setting from file**

This field will appear only when a USB flash device is detected. Select this field to restore setting from the USB flash device.

► Updating the BIOS

To update the BIOS, you will need the new BIOS file and a flash utility. Please contact technical support or your sales representative for the files and specific instructions about how to update BIOS with the flash utility. For updating AMI BIOS in UEFI mode, you may refer to the how-to video at <https://www.dfi.com/Knowledge/Video/5>.

► Notice: BIOS SPI ROM

- 1. The Intel® Management Engine has already been integrated into this system board. Due to the safety concerns, the BIOS (SPI ROM) chip cannot be removed from this system board and used on another system board of the same model.
- 2. The BIOS (SPI ROM) on this system board must be the original equipment from the factory and cannot be used to replace one which has been utilized on other system boards.
- 3. If you do not follow the methods above, the Intel® Management Engine will not be updated and will cease to be effective.



Note:

- a. You can take advantage of flash tools to update the default configuration of the BIOS (SPI ROM) to the latest version anytime.
- b. When the BIOS IC needs to be replaced, you have to populate it properly onto the system board after the EEPROM programmer has been burned and follow the technical person's instructions to confirm that the MAC address should be burned or not.