



# CMS631-Q470E/H420E

ATX Industrial Motherboard  
User's Manual

## Copyright

This publication contains information that is protected by copyright. No part of it may be reproduced in any form or by any means or used to make any transformation/adaptation without the prior written permission from the copyright holders.

This publication is provided for informational purposes only. The manufacturer makes no representations or warranties with respect to the contents or use of this manual and specifically disclaims any express or implied warranties of merchantability or fitness for any particular purpose. The user will assume the entire risk of the use or the results of the use of this document. Further, the manufacturer reserves the right to revise this publication and make changes to its contents at any time, without obligation to notify any person or entity of such revisions or changes.

Changes after the publication's first release will be based on the product's revision. The website will always provide the most updated information.

© 2023. All Rights Reserved.

## Trademarks

Product names or trademarks appearing in this manual are for identification purpose only and are the properties of the respective owners.

## FCC and DOC Statement on Class B

This equipment has been tested and found to comply with the limits for a Class B digital device, pursuant to Part 15 of the FCC rules. These limits are designed to provide reasonable protection against harmful interference when the equipment is operated in a residential installation. This equipment generates, uses and can radiate radio frequency energy and, if not installed and used in accordance with the instruction manual, may cause harmful interference to radio communications. However, there is no guarantee that interference will not occur in a particular installation. If this equipment does cause harmful interference to radio or television reception, which can be determined by turning the equipment off and on, the user is encouraged to try to correct the interference by one or more of the following measures:

- Reorient or relocate the receiving antenna.
- Increase the separation between the equipment and the receiver.
- Connect the equipment into an outlet on a circuit different from that to which the receiver is connected.
- Consult the dealer or an experienced radio TV technician for help.

## Notice:

1. The changes or modifications not expressly approved by the party responsible for compliance could void the user's authority to operate the equipment.
2. Shielded interface cables must be used in order to comply with the emission limits.

# Table of Contents

Chapter 1 - Introduction.....	6
Specifications .....	6
Dimensions .....	8
Block Diagram .....	8
Chapter 2 - Hardware Installation.....	9
Board Layout.....	9
System Memory .....	10
Installing the DIMM Module .....	10
Removing the DIMM Module.....	11
CPU.....	12
Installing the CPU Fan and Heat Sink.....	12
Jumper Settings .....	13
Clear CMOS Data (JP5) .....	13
COM1/COM2 RS232 Power Select (JP4&JP7).....	13
DIO Power & Voltage (JP11/12/13/14/15).....	14
AT/ATX Mode (JP26).....	14
M.2 Connector Power Control (JP27&JP28) .....	15
Pin Assignment .....	15
InnoAGE HDR1 (JP24) .....	15
USB Ports .....	16
Graphics Interfaces .....	17
COM1 .....	17
RJ45 LAN Ports .....	18
Audio .....	18
Internal I/O Connectors .....	19
SATA -Serial ATA (J31, J32, J17, J23, J24, J25) .....	19
Digital I/O Connector (J2).....	19
COM Ports (J9, J11, J13, J15, J16).....	20
Cooling Fan Connectors.....	21
Power Connector .....	21
Front Panel (J18).....	22
S/PDIF Connector (AUJ1).....	22
LPC Connector (J21).....	23
Innoage HDD Power (CN37).....	23
Expansion Slots .....	24
Expansion Slots.....	24
Installing the M.2 Module .....	24
Battery .....	25
Chapter 4 - BIOS Settings.....	26
Overview .....	26
Main.....	27
Advanced .....	27
RC ACPI Configuration .....	28
CPU Configuration .....	28
Power & Performance.....	29
PCH-FW Configuration .....	29
Trusted Computing.....	30
NCT6126D Super IO Configuration .....	30
NCT6126D Super IO Configuration ▶ Serial Port 1,2 Configuration .....	31
NCT6126D Super IO Configuration ▶ Serial Port 3,4 Configuration .....	31
NCT6126D Super IO Configuration ▶ Serial Port 5,6 Configuration .....	32
NCT6126D HW Monitor .....	32
NCT5525D HW Monitor ▶ Smart FAN Function .....	33

Serial Port Console Redirection .....	33
Serial Port Console Redirection ▶ Console Redirection Settings.....	34
USB Configuration .....	34
Network Stack Configuration.....	35
CSM Configuration .....	35
USB Power Control .....	36
Chipset .....	37
Graphics Configuration .....	37
PEG Port Configuration .....	38
PEG Port Configuration ▶ PEG Port Feature Configuration .....	38
PCH-IO Configuration .....	39
PCH-IO Configuration ▶ PCI Express Configuration .....	40
PCH-IO Configuration ▶ SATA And RST Configuration.....	40
PCH-IO Configuration ▶ HD Audio Configuration .....	41
Security .....	42
Secure Boot.....	42
Boot .....	43
Save & Exit .....	43
Updating the BIOS.....	44
Notice: BIOS SPI ROM.....	44

## About this Manual

This manual can be downloaded from the website.

The manual is subject to change and update without notice, and may be based on editions that do not resemble your actual products. Please visit our website or contact our sales representatives for the latest editions.

## Warranty

1. Warranty does not cover damages or failures that occur from misuse of the product, inability to use the product, unauthorized replacement or alteration of components and product specifications.
2. The warranty is void if the product has been subjected to physical abuse, improper installation, modification, accidents or unauthorized repair of the product.
3. Unless otherwise instructed in this user's manual, the user may not, under any circumstances, attempt to perform service, adjustments or repairs on the product, whether in or out of warranty. It must be returned to the purchase point, factory or authorized service agency for all such work.
4. We will not be liable for any indirect, special, incidental or consequential damages to the product that has been modified or altered.

## Static Electricity Precautions

It is quite easy to inadvertently damage your PC, system board, components or devices even before installing them in your system unit. Static electrical discharge can damage computer components without causing any signs of physical damage. You must take extra care in handling them to ensure against electrostatic build-up.

1. To prevent electrostatic build-up, leave the system board in its anti-static bag until you are ready to install it.
2. Wear an antistatic wrist strap.
3. Do all preparation work on a static-free surface.
4. Hold the device only by its edges. Be careful not to touch any of the components, contacts or connections.
5. Avoid touching the pins or contacts on all modules and connectors. Hold modules or connectors by their ends.



### Important:

Electrostatic discharge (ESD) can damage your processor, disk drive and other components. Perform the upgrade instruction procedures described at an ESD workstation only. If such a station is not available, you can provide some ESD protection by wearing an antistatic wrist strap and attaching it to a metal part of the system chassis. If a wrist strap is unavailable, establish and maintain contact with the system chassis throughout any procedures requiring ESD protection.

## Safety Measures

- To avoid damage to the system, use the correct AC input voltage range.
- To reduce the risk of electric shock, unplug the power cord before removing the system chassis cover for installation or servicing. After installation or servicing, cover the system chassis before plugging the power cord.

## About the Package

The package contains the following items. If any of these items are missing or damaged, please contact your dealer or sales representative for assistance.

- 1 CMS631 motherboard
- 1 COM port cables (Length: 300mm, 2 x COM ports)
- 1 Serial ATA data cable (Length: 500mm)
- 1 I/O shield (A49-CMS631-000G)

The board and accessories in the package may not come similar to the information listed above. This may differ in accordance with the sales region or models in which it was sold. For more information about the standard package in your region, please contact your dealer or sales representative.

## Before Using the System Board

When installing the system board in a new system, you will need at least the following internal components.

- Memory module
- Storage device such as a hard disk drive.
- Power supply

External system peripherals may also be required for navigation and display, including at least a keyboard, a mouse and a video display monitor.

## Chapter 1 - Introduction

### ▲ Specifications

<b>SYSTEM</b>	<b>Processor</b>	10th Generation Intel® LGA 1200 Socket Processors, TDP support up to 125W Intel® Core™ i9-10900E (10 Cores, 20M Cache, up to 4.7 GHz); 65W Intel® Core™ i9-10900TE (10 Cores, 20M Cache, up to 4.5 GHz); 35W Intel® Core™ i7-10700E (8 Cores, 16M Cache, up to 4.5 GHz); 65W Intel® Core™ i7-10700TE (8 Cores, 16M Cache, up to 4.4 GHz); 35W Intel® Core™ i5-10500E (6 Cores, 12M Cache, up to 4.2 GHz); 65W Intel® Core™ i5-10500TE (6 Cores, 12M Cache, up to 3.7 GHz); 35W Intel® Core™ i3-10100E (4 Cores, 8M Cache, up to 3.8 GHz); 65W Intel® Core™ i3-10100TE (4 Cores, 8M Cache, up to 3.6 GHz); 35W Intel® Pentium® G6400E (2 Cores, 4M Cache, 3.8 GHz); 58W Intel® Celeron® G5900E (2 Cores, 2M Cache, 3.2 GHz); 58W Intel® Celeron® G5900TE (2 Cores, 2M Cache, 3.0 GHz); 35W
	<b>Chipset</b>	Intel® Q470E/H420E Chipset
	<b>Memory</b>	Q470E: Four 288-pin Non-ECC UDIMM up to 128GB H420E: Two 288-pin Non-ECC UDIMM up to 64GB Dual Channel DDR4 2400/2666/2933MHz
	<b>BIOS</b>	AMI
<b>GRAPHICS</b>	<b>Controller</b>	Intel® HD Gen 9 Graphics
	<b>Feature</b>	OpenGL 4.5, DirectX 12, OpenCL 2.1 HW Decode: AVC/H.264, MPEG2, VC1/WMV9, JPEG/MJPEG, HEVC/H265, VP8, VP9 HW Encode: MPEG2, AVC/H264, JPEG, HEVC/H265, VP8, VP9
	<b>Display</b>	1 x VGA, resolution up to 1920x1200 @ 60Hz 1 x DP++, resolution up to 4096x2160 @ 60Hz 1 x HDMI 1.4b, resolution up to 4096x2160 @ 24Hz
	<b>Multiple Displays</b>	Q470E: VGA + DP++ + HDMI (Triple Display) H420E: VGA + DP++ / VGA + HDMI / DP++ + HDMI (Dual Display)

<b>EXPANSION</b>	<b>Interface</b>	1 x PCIe x16 (Gen 3) 1 x PCIe x4 (Gen 3) 5 x PCI  Q470E: 1 x M.2 2242/2260/2280 M key (PCIe Gen3 x4 NVMe/SATA/Intel® Optane Memory support) 1 x M.2 2242/2260/2280 M key (PCIe Gen3 x1/SATA as optional, MOQ required) 1 x M.2 2230 E key (PCIe Gen3 x2/USB 2.0 as optional, MOQ required)  H420E: 1 x M.2 2242/2260/2280 M key (SATA as optional, MOQ required)
<b>AUDIO</b>	<b>Audio Codec</b>	Realtek ALC888
<b>ETHERNET</b>	<b>Controller</b>	1 x Intel® I210AT PCIe (10/100/1000Mbps) 1 x Intel® I219LM/I219V with iAMT12.0 (10/100/1000Mbps) (only Q470E Core i9/i7/i5 supports iAMT)
<b>REAR I/O</b>	<b>Ethernet</b>	2 x GbE (RJ-45)
	<b>Serial</b>	1 x RS-232/422/485 (RS-232 w/ power) (DB-9)
	<b>USB</b>	Q470E: 2 x USB 3.2 Gen2 2 x USB 3.2 Gen1 2 x USB 2.0  H420E: 4 x USB 3.2 Gen1 2 x USB 2.0
	<b>Display</b>	1 x VGA 1 x DP++ 1 x HDMI
	<b>Audio</b>	1 x Line-out, 1 x Mic-in, 1 x Line-in (optional, MOQ required)
<b>INTERNAL I/O</b>	<b>Serial</b>	1 x RS-232/422/485 (RS-232 w/ power) (2.54mm pitch) 4 x RS-232 (2.54mm pitch)
	<b>USB</b>	Q470E: 2 x USB 3.2 Gen 1 4 x USB 2.0 (2.54mm pitch, colay vertical Type A, optional: MOQ required) 1 x USB 2.0 vertical Type A  H420E: 2 x USB 3.2 Gen 1 2 x USB 2.0 (2.54mm pitch, colay vertical Type A, optional: MOQ required)

<b>Audio</b>	1 x Front Audio Header 1 x S/PDIF
<b>SATA</b>	Q470E: 6 x SATA 3.0 (up to 6Gb/s) RAID 0/1/5/10 one SATA port shares with M.2 M-key  H420E: 4 x SATA 3.0 (up to 6Gb/s) one SATA port shares with M.2 M-key
<b>DIO</b>	1 x 16-bit DIO
<b>LPC</b>	1 x LPC (supports LPC EXT-RS232/RS485 module)
<b>SMBus</b>	1 x SMBus
<b>PS/2</b>	1 x PS/2 (mini-DIN-6)
<b>WATCHDOG TIMER</b>	<b>Output &amp; Interval</b> System Reset, Programmable via Software from 1 to 255 Seconds
<b>SECURITY</b>	<b>TPM</b> Infineon TPM2.0 (optional, MOQ required)
<b>POWER</b>	<b>Type</b> ATX  <b>Connector</b> 8-pin ATX 12V power 24-pin ATX power  <b>Consumption</b> Typical: i9-10900K: 3.3V @ 0.13A (0.429W); 5V @ 0.7A (3.5W); 12V @ 0.44A (5.28W) Max.: i9-10900K: 3.3V @ 0.18A (0.594W); 5V @ 1.59A (7.95W); 12V @ 14.22A (170.64W)  <b>RTC Battery</b> RTC Battery CR2032 Coin Cell
<b>OS SUPPORT</b>	Windows 10 IoT Enterprise 64-bit/ Windows 11 GAC Linux Ubuntu 20.04
<b>ENVIRONMENT</b>	<b>Temperature</b> Operating: -5 to 65°C Storage: -40 to 85°C  <b>Humidity</b> Operating: 5 to 90% RH Storage: 5 to 90% RH  <b>MTBF</b> <b>Q470E:</b> 504,168 hrs @ 25°C ; 278,849 hrs @ 45°C ; 172,277 hrs @ 60°C ; 146,454 hrs @ 65°C Calculation Model: Telcordia Issue 4 Environment: GB, GC - Ground Benign, Controlled <b>H420E:</b> 521,024 hrs @ 25°C ; 292,119 hrs @ 45°C ; 181,960 hrs @ 60°C ; 155,038 hrs @ 65°C Calculation Model: Telcordia Issue 4 Environment: GB, GC - Ground Benign, Controlled

<b>MECHANICAL</b>	<b>Dimensions</b> ATX Form Factor 305mm (12") x 244mm (9.6")
	<b>Height</b> PCB: 1.6mm Top Side: 37.7mm Bottom Side: 3mm
<b>Certifications</b>	<b>Certifications</b> CE, FCC Class B

▲ Dimensions

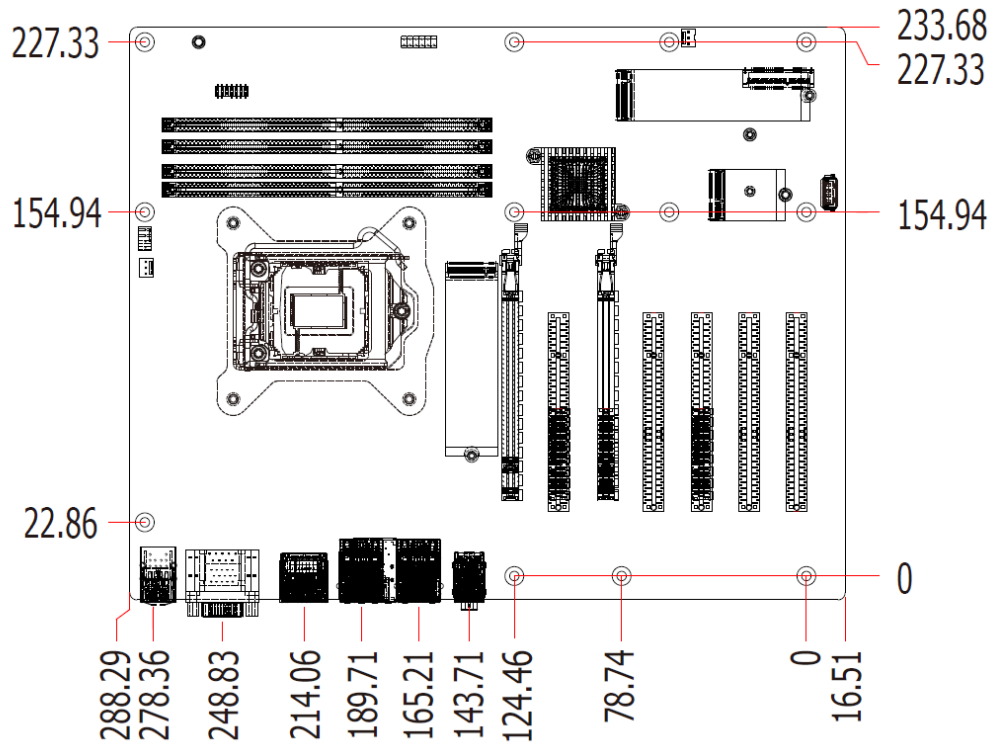

▲ Block Diagram

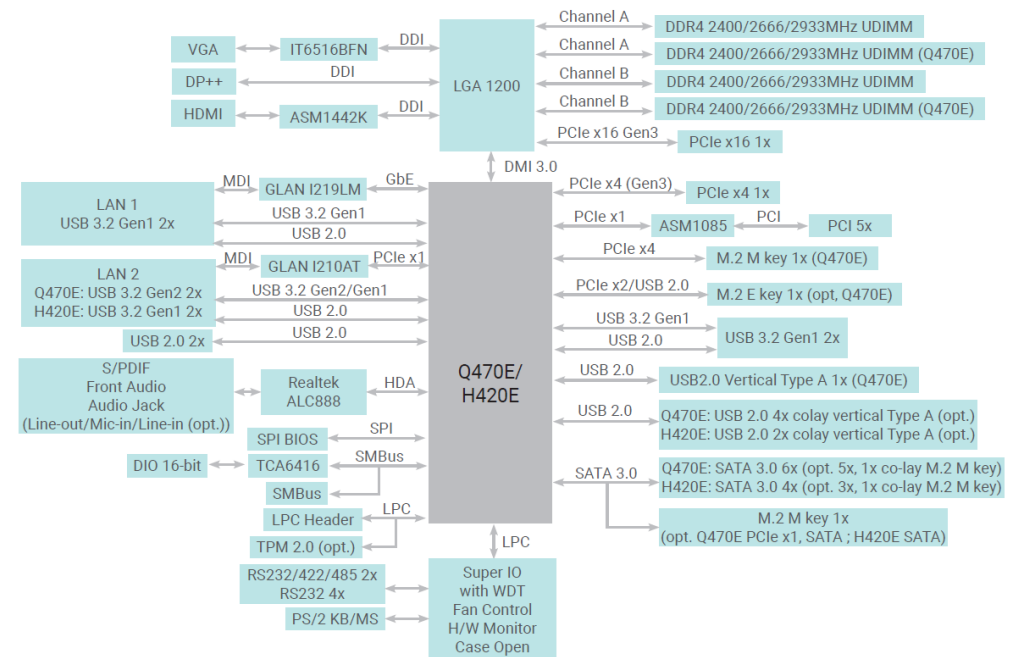



# Chapter 2 - Hardware Installation

## ▲ Board Layout

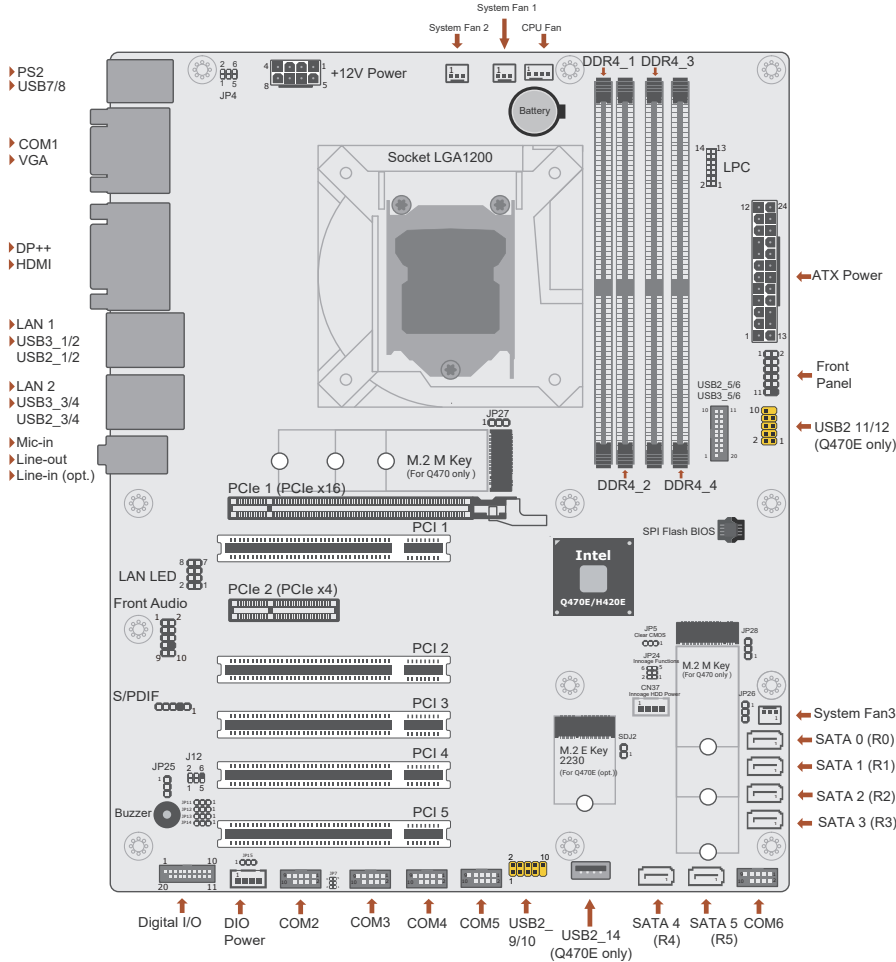

**Note:** Some components are optional and only available upon request.

**Important:** Electrostatic discharge (ESD) can damage your board, processor, disk drives, add-in boards, and other components. Perform installation procedures at an ESD workstation only. If such a station is not available, you can provide some ESD protection by wearing an antistatic wrist strap and attaching it to a metal part of the system chassis. If a wrist strap is unavailable, establish and maintain contact with the system chassis throughout any procedures requiring ESD protection.

▲ System Memory

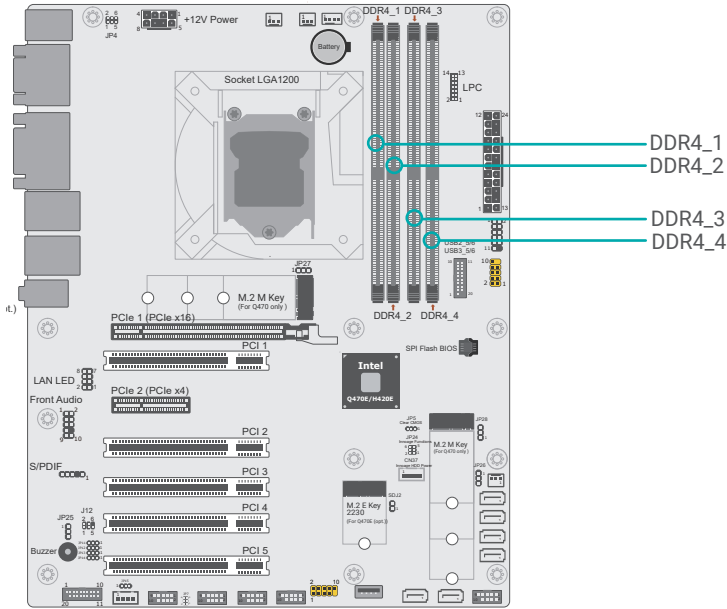

The system board supports the following memory interface.

Single Channel (SC)

Data will be accessed in chunks of 64 bits from the memory channels. DIMMs are on the same channel. DIMMs in a channel can be identical or completely different. However, we highly recommend using identical DIMMs. Not all slots need to be populated.

Dual Channel (DC)

Data will be accessed in chunks of 128 bits from the memory channels. Dual channel provides better system performance because it doubles the data transfer rate.

Features

- Q470E: Four 288-pin Non-ECC UDIMM up to 128GB
- H420E: Two 288-pin Non-ECC UDIMM up to 64GB
- Dual Channel DDR4 2400/2666/2933MHz

▲ System Memory

Installing the DIMM Module

Before installing the memory module, please make sure that the following safety cautions are well-attended.

1. Make sure the PC and all other peripheral devices connected to it has been powered down.
2. Disconnect all power cords and cables.
3. Locate the DIMM socket on the system board
4. Make sure the notch on memory card is aligned to the key on the socket.

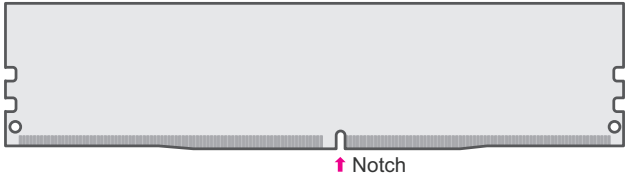

Memory Module



Socket Top View



Socket Side View

▲ System Memory ▲ Installing the DIMM Module

Please follow the steps below to install the memory card into the socket.

**Step 1:**  
Press the eject tabs at both ends of the socket outward and downward to release them from the locked position.

**Step 2:**  
Insert the memory card into the slot while making sure the notch and the key are aligned. Press the card down firmly with fingers while applying and maintaining even pressure on both ends.

**Step 3:**  
The tabs snap automatically to the edges of the card and lock the card in place.

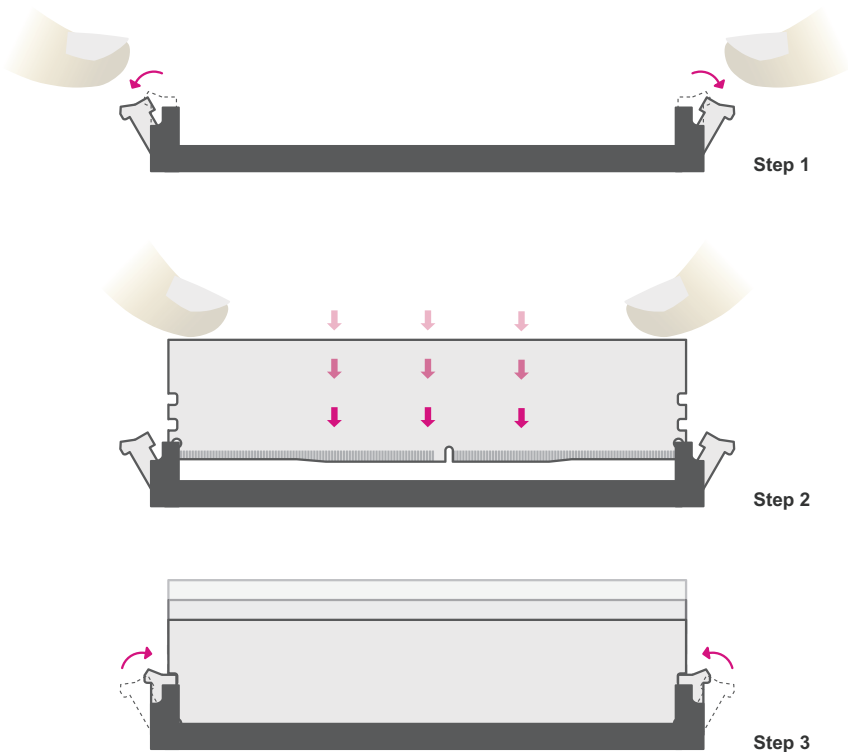

▲ System Memory

**Removing the DIMM Module**

Please follow the steps below to remove the memory card from the socket.

**Step 1:**  
Press the eject tabs at both ends of the socket outward and downward to release them from the locked position.

**Step 2:**  
The memory card ejects from the slot automatically.

**Step 3:**  
Hold the card by its edges and remove it from the slot.

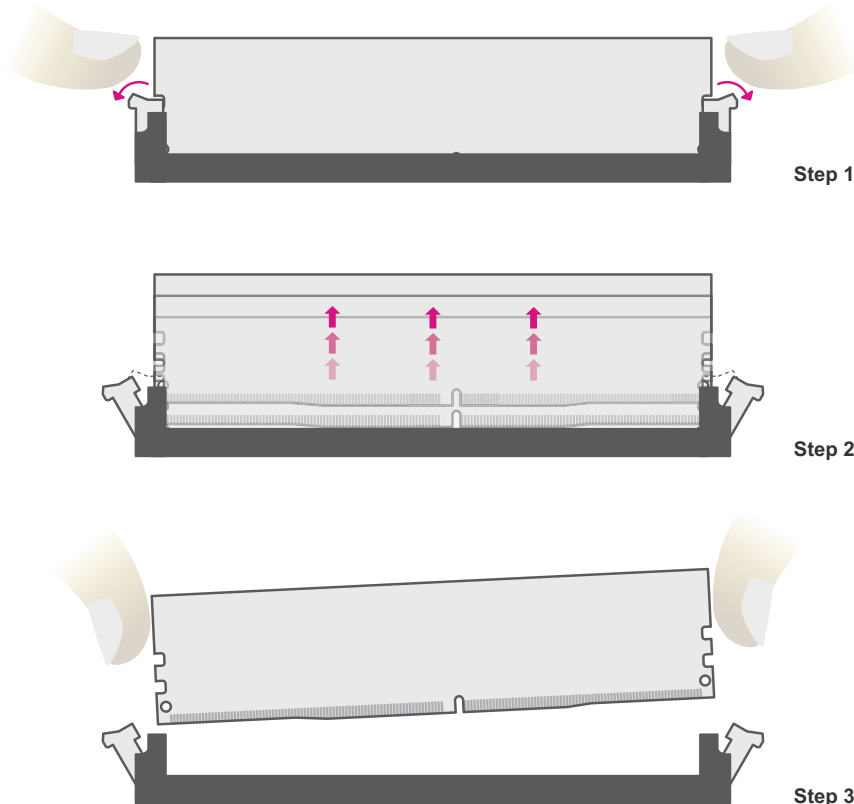

▲ CPU

Installing the CPU Fan and Heat Sink

The CPU must be kept cool by using a CPU fan with heat sink. Without sufficient air circulation across the CPU and heat sink, the CPU will overheat damaging both the CPU and system board.

Before you place the heat sink on the CPU, you must apply a thermal paste onto the top of the heat sink. The thermal paste is usually supplied when you purchase the fan with heat sink assembly. Do not spread the paste all over the surface. When you later place the CPU on top of the heat sink, the compound will disperse evenly.

Some heat sinks come with a patch of pre-applied thermal paste. Do not apply thermal paste if the fan with heat sink already has a patch of thermal paste on its underside. Peel the strip that covers the paste before you place the CPU on top of the heat sink.

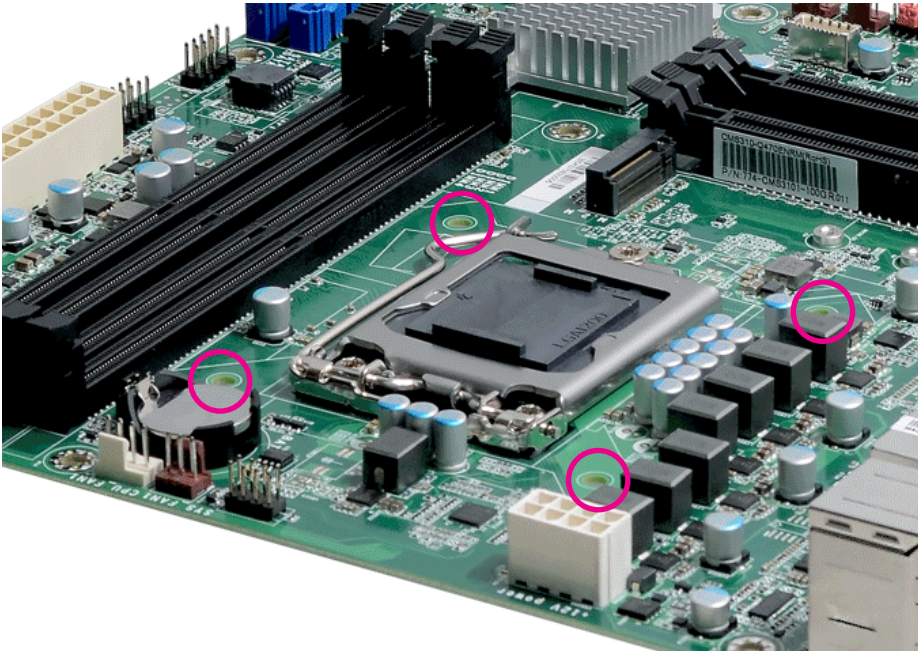

There are 4 screw holes around the CPU for the heat sink to be mounted.

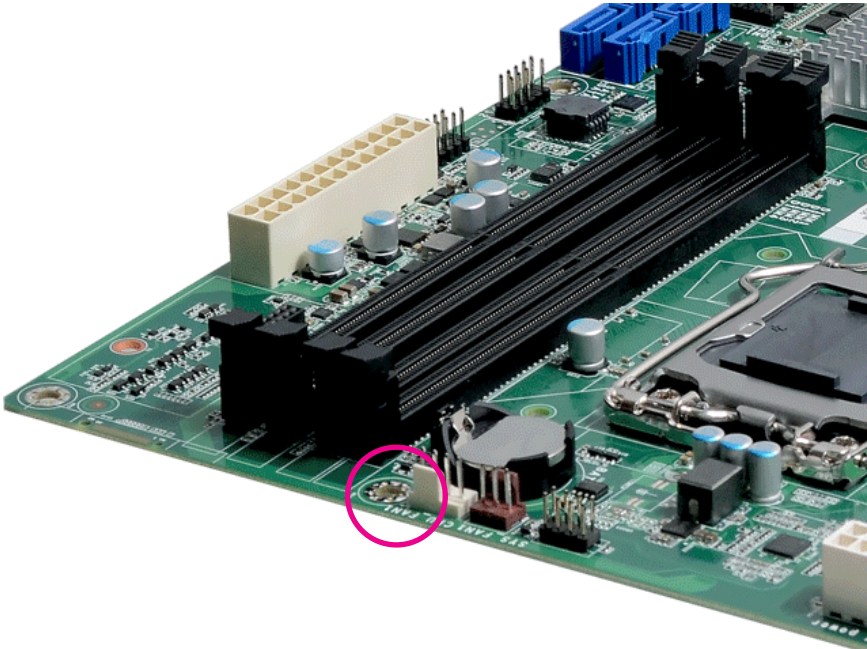

Align the 4 screw holes and tighten the heat sink up by inserting screws, DO remember to connect the fan cable on the board.

▲ **Jumper Settings**

Clear CMOS Data (JP5)

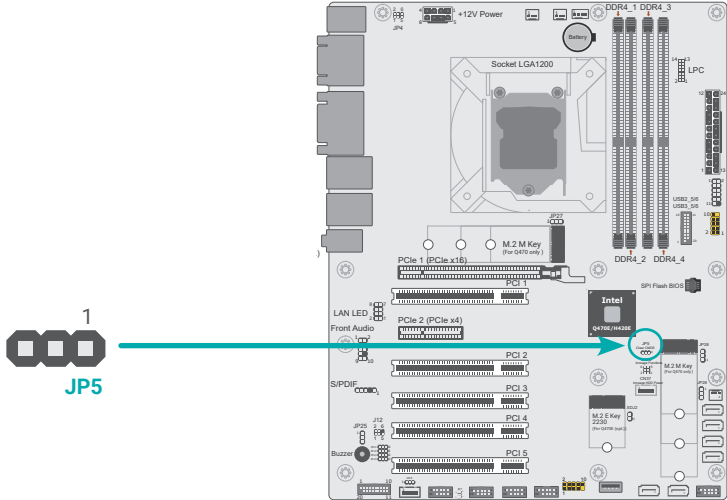

If any anomaly of the followings is encountered –

- a) CMOS data is corrupted;
- b) you forgot the supervisor or user password;
- c) failure to start the system due to BIOS mis-configuration

– it is suggested that the system be reconfigured with default values stored in the ROM BIOS. To load the default values stored in the ROM BIOS, please follow the steps below.

1. Power-off the system and unplug the power cord.
2. Put a jumper cap on pin 2 and pin 3. Wait for a few seconds and set it back to its default setting, i.e. jumper cap on pin 1 and pin 2.
3. Plug the power cord and power-on the system.



■ 1-2 On: Normal (default)



■ 2-3 On: Clear CMOS Data

COM1/COM2 RS232 Power Select (JP4&JP7)

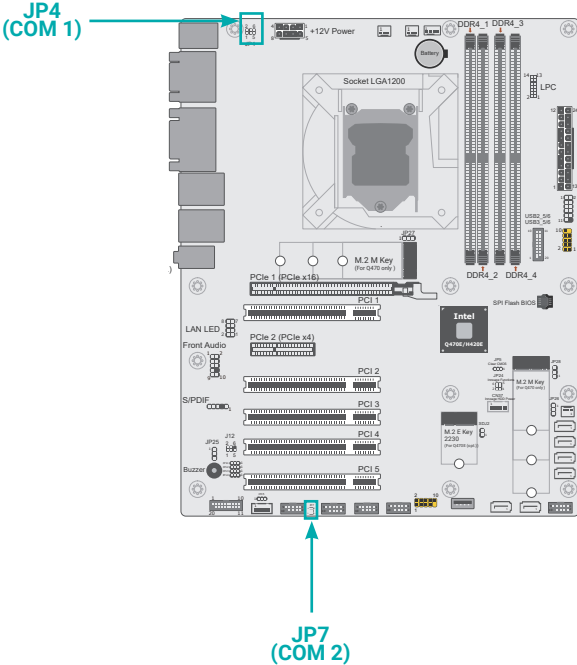

JP4 (for COM 1) and JP7 (for COM 2) are used to configure Serial COM ports to pure RS232 or RS232 with power. The pin functions of COM 1 and COM 2 will vary according to JP4's and JP7's setting respectively.

■ JP4 (COM 1) / JP7 (COM 2)



1-3, 2-4 On:  
 RS232 (default)



3-5, 4-6 On:  
 RS232 with power

DIO Power & Voltage (JP11/12/13/14/15)

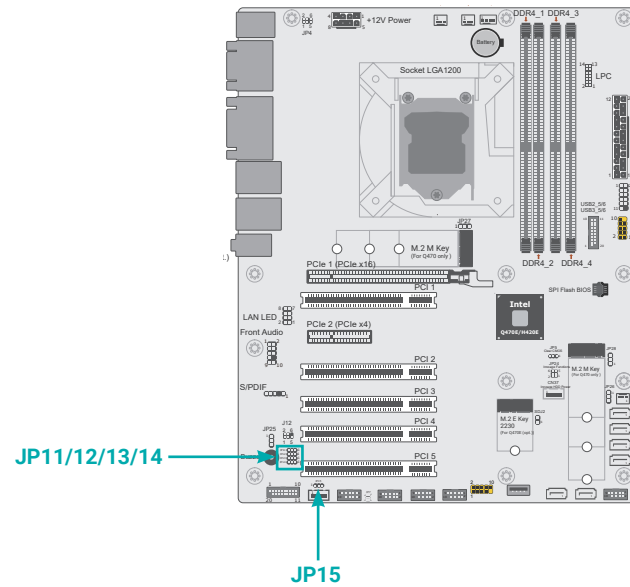

- JP11 (DIO 0~3 PWR) / JP12 (DIO 4~7 PWR) / JP13 (DIO 8~11 PWR) / JP14 (DIO 12~15 PWR)

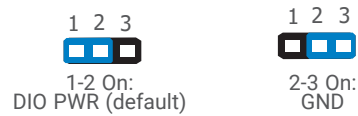

■ JP15

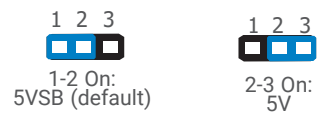

AT/ATX Mode (JP26)

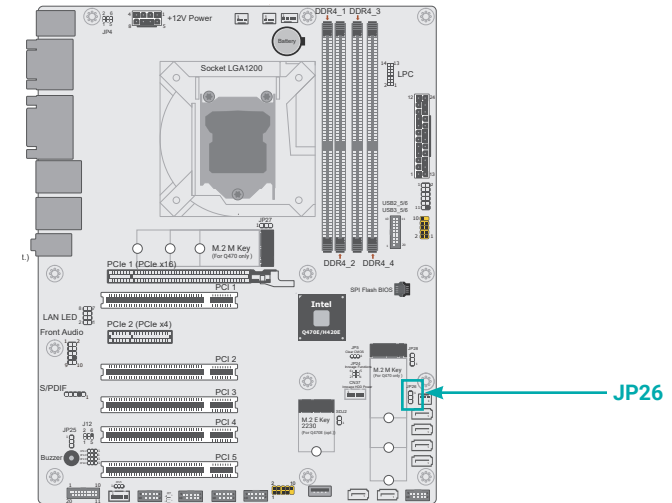

■ AT mode



■ ATX mode



▲ Pin Assignment

M.2 Connector Power Control (JP27&JP28)

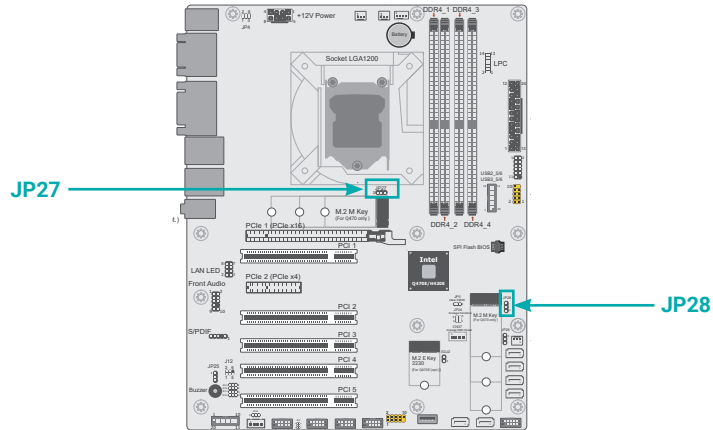

JP27 and JP28 are used to control the power of M2CN1(M.2-M1) and M2CN2(M.2-M2).



InnoAGE HDR1 (JP24)

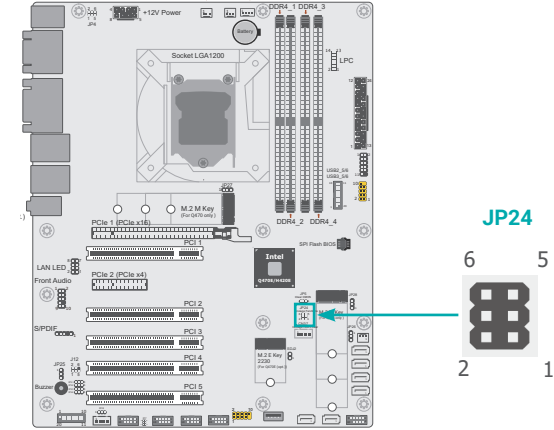

JP24 is used to set InnoAGE functions.

\*Note: Currently support InnoAge out-of-band management through RJ45 only.

Pin	Assignment
1	INNOAGE_PCRST#
2	INNOAGE_RECOV#
3	INNOAGE_PWRLED#
4	INNOAGE_HDDLED#
5	INNOAGE_PWRBTN#
6	GND

**USB Ports**

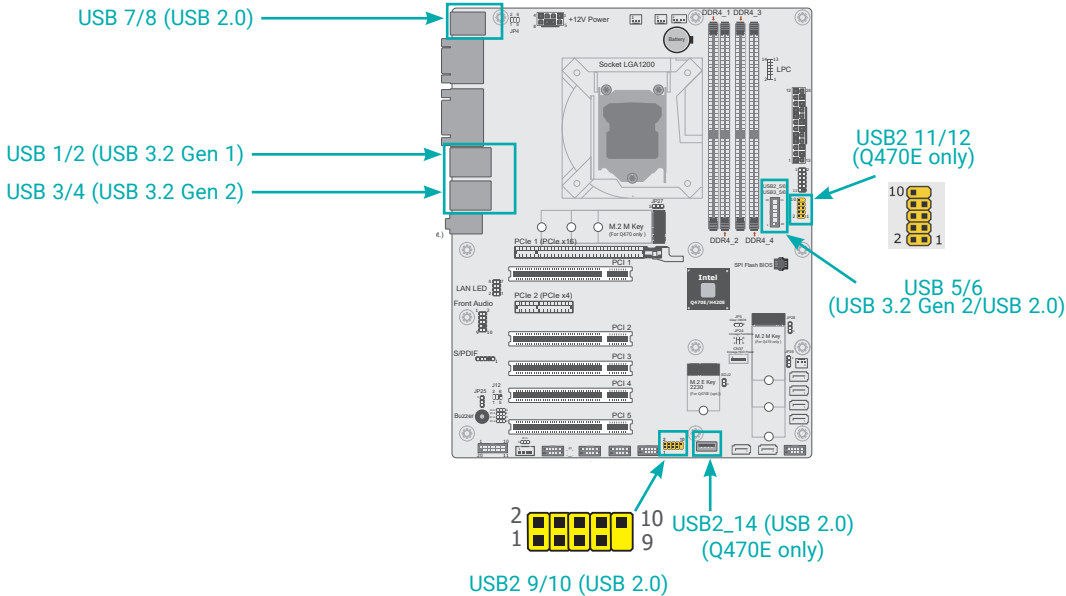

The USB device allows data exchange between your computer and a wide range of simultaneously accessible external Plug and Play peripherals. The system board is equipped with multiple USB ports as listed below:

- 2 x USB 3.2 Gen 1 rear ports (USB 1/2)
- 2 x USB 3.2 Gen 2 rear ports (USB 3/4)
- 2 x USB 2.0 rear ports (USB 7/8)
- 2 x USB 3.1 Gen 2 internal ports (USB 5/6)
- 2 x USB 2.0 internal ports, box headers (USB 9/10)
- 2 x USB 2.0 internal ports, box headers (USB 11/12)
- 1 x USB 2.0 internal ports, (USB 14)

■ USB 2.0 9/10 & 11/12 (UBJ4 & UBJ1)

Pin	Assignment	Pin	Assignment
1	SBV	2	SBV
3	Data-	4	Data-
5	Data+	6	Data+
7	GND	8	GND
9	---	10	N.C.

■ USB 2.0/3.2 USB 5/6 (UBJ3)

Pin	Assignment	Pin	Assignment
10	5V	11	USBP_C_5P
9	USBP_C_6P	12	USBP_C_5N
8	USBP_C_6N	13	GND
7	GND	14	USB3_TX6_DP
6	USB3_TX5_DP	15	USB3_TX6_DN
5	USB3_TX5_DN	16	GND
4	GND	17	USB3_RX6_DP
3	USB3_RX5_DP	18	USB3_RX6_DN
2	USB3_RX5_DN	19	SBV3
1	SBV3	20	---

The internal USB ports may be mounted on a card-edge bracket. Install the card-edge bracket to an available slot at the rear of the system chassis and then insert the USB port cables to a connector.

**Wake-On-USB Keyboard/Mouse**

The Wake-On-USB Keyboard/Mouse function allows you to use a USB keyboard or USB mouse to wake up a system from the S3 (STR - Suspend To RAM) state.



Graphics Interfaces

COM1

The display ports consist of the following:

- 1 DP++ Port
- 1 HDMI port
- 1 VGA port

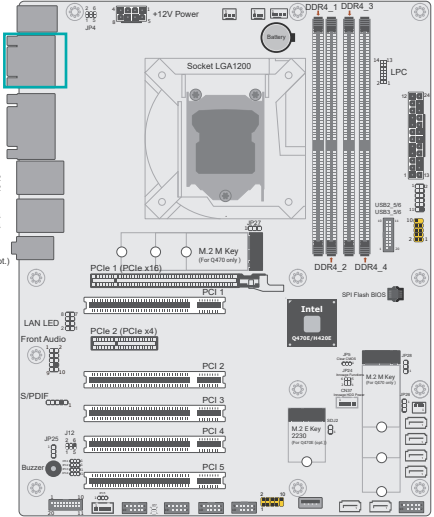
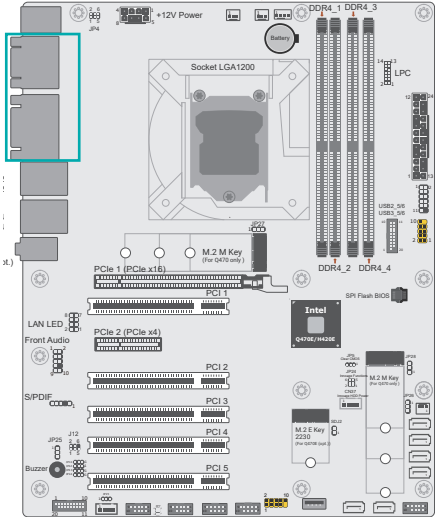

■ COM Port Pin Assignment

**DP++ Port**

The DP++ port which carries both digital audio and video signals is used to connect a LCD monitor or a digital TV that has the DP++ port.

**HDMI Port**

The HDMI port which carries both digital audio and video signals is used to connect a LCD monitor or digital TV that has the HDMI port.

**VGA Port**

The VGA port is used for connecting a VGA monitor. Connect the monitor’s 15-pin D-shell cable connector to the VGA port. After you plug the monitor’s cable connector into the VGA port, gently tighten the cable screws to hold the connector in place.

Pin	RS232	RS232 with Power	RS422 Full Duplex	RS485
1	DCD-	+12V	RX+	Data+
2	SIN-	SIN-	RX-	Data-
3	SO-	SO-	TX+	---
4	DTR-	DTR-	TX-	---
5	GND	GND	GND	GND
6	DSR-	DSR-	---	---
7	RTS-	RTS-	---	---
8	CTS-	CTS-	---	---
9	RI-	+5V	---	---

### RJ45 LAN Ports

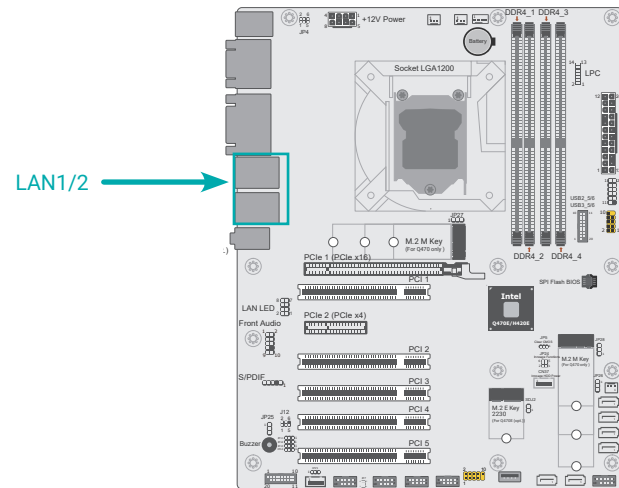

#### Features

- 2 x GbE (RJ-45)

The LAN ports allow the system board to connect to a local area network by means of a network hub.

### Audio

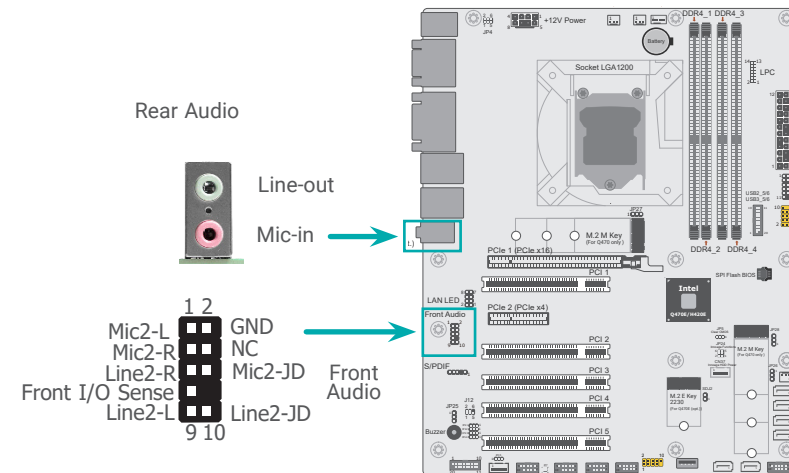

#### Rear Audio

The system board is equipped with 2 audio jacks (Line-out and Mic-in). Line-in jack is available upon request. A jack is a one-hole connecting interface for inserting a plug.

- Optional Line-in Jack (Light Blue)  
 This jack is used to connect any audio devices such as Hi-fi set, CD player, tape player, AM/FM radio tuner, synthesizer, etc.
- Line-out Jack (Lime)  
 This jack is used to connect a headphone or external speakers.
- Mic-in Jack (Pink)  
 This jack is used to connect an external microphone.

#### Front Audio

The front audio connector allows you to connect to the second line-out and mic-in jacks that are at the front panel of your system.

▲ Internal I/O Connectors

SATA -Serial ATA (J31, J32, J17, J23, J24, J25)

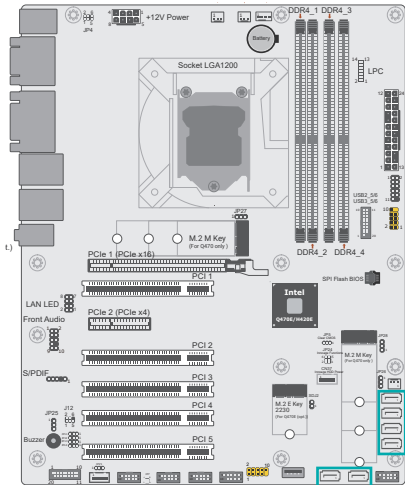

■ SATA Pin Assignment

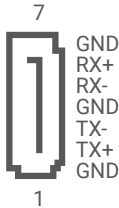

The Serial ATA (SATA) connectors are used to connect the Serial ATA device. SATA 3.0 is supported by the five SATA ports and provides data rate up to 6Gb/s. Connect one end of the Serial ATA cable to a SATA connector and the other end to your Serial ATA device.

Features

- 6 Serial ATA 3.0 ports with data transfer rate up to 6Gb/s
- Integrated Advanced Host Controller Interface (AHCI) controller
- Support RAID 0, RAID 1, RAID 5, RAID 10

▲ Internal I/O Connectors

Digital I/O Connector (J2)

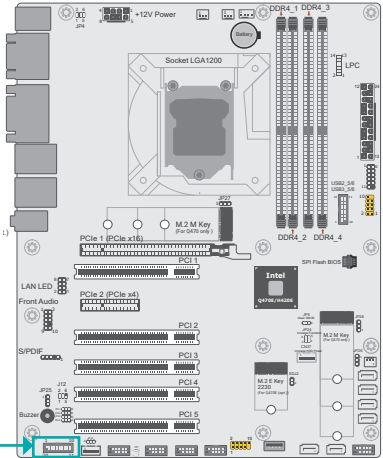

The 16-bit Digital I/O connector provides powering-on function to external devices that are connected to these connectors. The pin functions of the 16-bit digital I/O connector are listed below.

Pin	Function	Pin	Function
1	GND	2	GND
3	DIO7	4	DIO6
5	DIO5	6	DIO4
7	DIO3	8	DIO2
9	DIO1	10	DIO0
11	DIO8	12	DIO9
13	DIO10	14	DIO11
15	DIO12	16	DIO13
17	DIO14	18	DIO15
19	GND	20	---

▲ Internal I/O Connectors

COM Ports (J9, J11, J13, J15, J16)

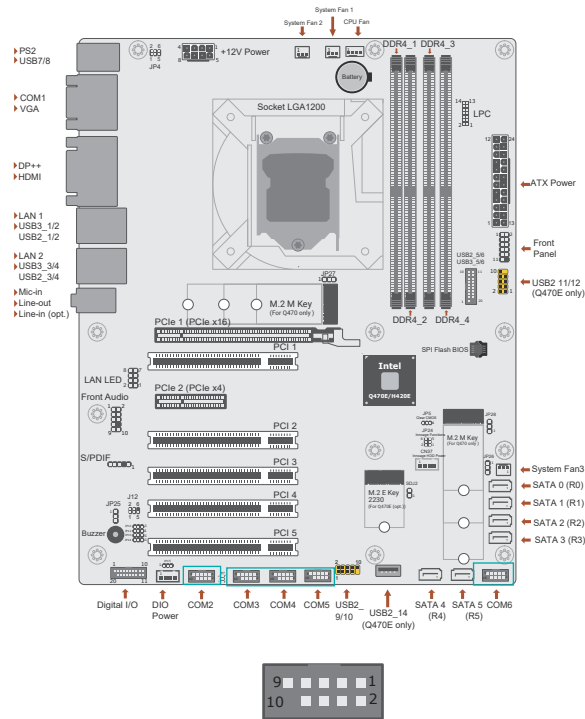

Connecting External Serial Ports

Your COM port may come mounted on a card-edge bracket. Install the card-edge bracket to an available slot at the rear of the system chassis then insert the serial port cable to the COM connector. Make sure the colored stripe on the ribbon cable is aligned with pin 1 of the COM connector.

■ COM Port Pin Assignment

Pin	RS232	RS232 with Power	RS422 Full Duplex	RS485
1	DCD-	+12V	RX+	Data+
2	SIN-	SIN-	RX-	Data-
3	SO-	SO-	TX+	---
4	DTR-	DTR-	TX-	---
5	GND	GND	GND	GND
6	DSR-	DSR-	---	---
7	RTS-	RTS-	---	---
8	CTS-	CTS-	---	---
9	RI-	+5V	---	---

▲ Internal I/O Connectors

Cooling Fan Connectors

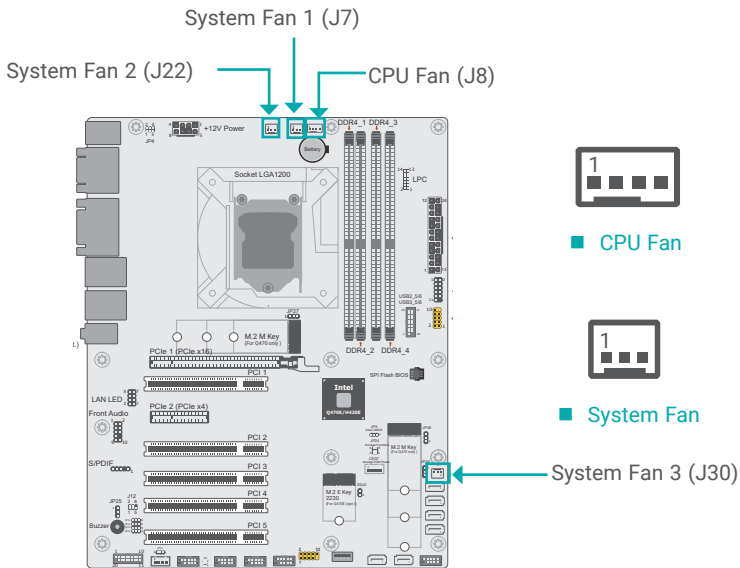

These fan connectors are used to connect cooling fans. The cooling fans will provide adequate airflow throughout the chassis to prevent overheating the CPU and system board components.

■ 4-pin Fan Pin Assignment

Pin	Assignment
1	Ground
2	12V
3	RPM
4	Control

■ 3-pin Fan Pin Assignment

Pin	Assignment
1	GND
2	PWM
3	TACH

▲ Internal I/O Connectors

Power Connector

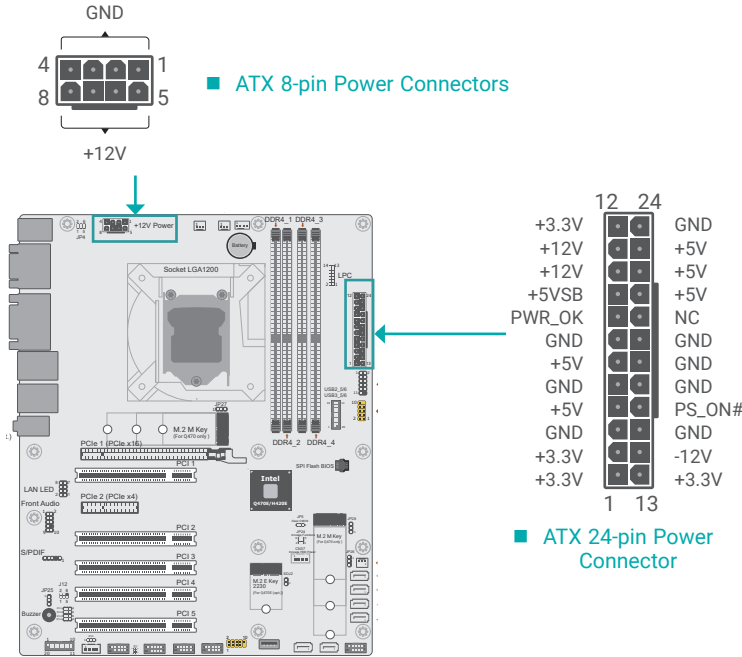

Use a power supply that complies with the ATX12V Power Supply Design Guide Version 1.1. An ATX12V power supply unit has a standard 24-pin ATX main power connector that must be inserted into the 24-pin connector. The 8-pin +12V power connector enables the delivery of more +12VDC current to the processor's Voltage Regulator Module (VRM).

The power connectors from the power supply unit are designed to fit the 24-pin and 8-pin connectors in only one orientation. Make sure to find the proper orientation before plugging the connectors.

The system board requires a minimum of 300 Watt power supply to operate. Your system configuration (CPU power, amount of memory, add-in cards, peripherals, etc.) may exceed the minimum power requirement. To ensure that adequate power is provided, we strongly recommend that the system is supplied with a minimum of 400 Watt power.



**Important:**

Insufficient power supplied to the system may result in instability or malfunction of the add-in boards and peripherals. Calculating the system's approximate power usage is important to ensure that the power supply meets the system's consumption requirements.

▲ Internal I/O Connectors

Front Panel (J18)

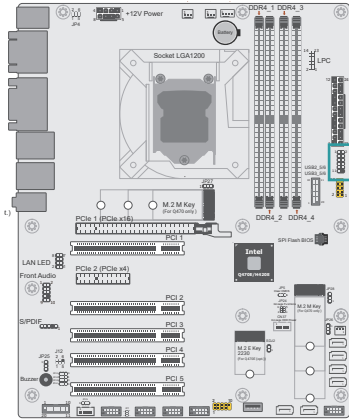

■ Front Panel Connector

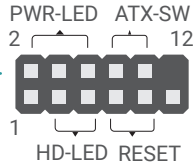

■ Front Panel Pin Assignment

Pin	Assignment	Pin	Assignment
1	N.C.	2	3V3SB
3	3V3	4	3V3SB
5	HD_LED	6	SUS_LED
7	Ground	8	Ground
9	PM_SYSRST	10	PWR_BTN-
11	N.C.	12	---

**HDD LED - Hard Disk Drive LED**

Lighting of the LED indicates that the hard drive is being accessed.

**RESET - Reset Switch**

This switch allows you to reboot without having to power off the system.

**Power/Standby LED**

When the system's power is on, this LED will light up. When the system is in the S1 (POS - Power On Suspend) state, it will blink at 1-second intervals. When the system is in the S3 (STR - Suspend To RAM) state, it will blink at 4-second intervals.

**Power Button**

This button is used to switch the system's power on or off .

▲ Internal I/O Connectors

S/PDIF Connector (AUJ1)

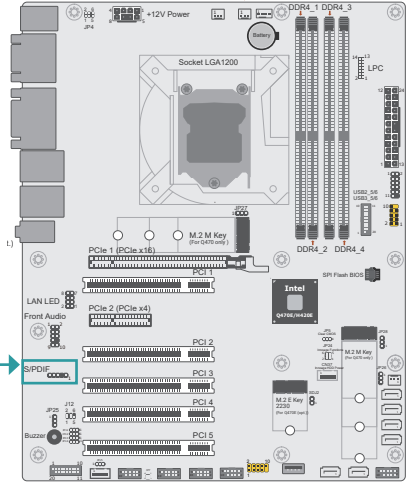

■ S/PDIF



The S/PDIF connector is used to connect an external S/PDIF port. Your S/PDIF port may be mounted on a card-edge bracket. Install the card-edge bracket to an available slot at the rear of the system chassis then connect the audio cable to the S/PDIF connector. Make sure pin 1 of the audio cable is aligned with pin 1 of the S/PDIF connector.

▲ Internal I/O Connectors

LPC Connector (J21)

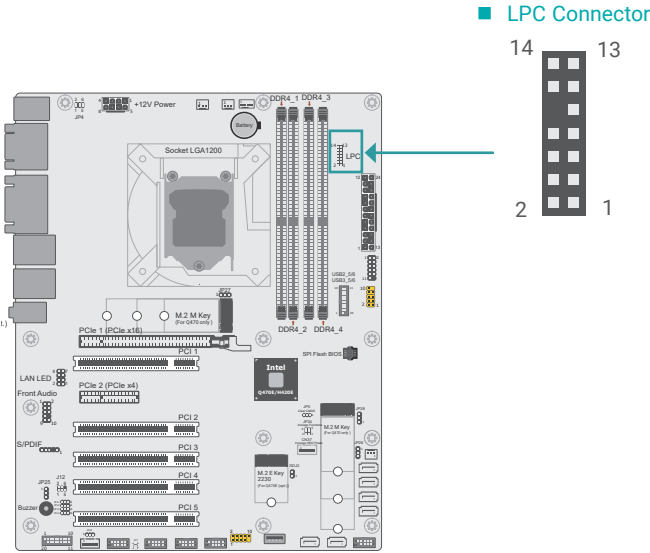

The Low Pin Count Interface was defined by Intel® Corporation to facilitate the industry's transition towards legacy free systems. It allows the integration of low-bandwidth legacy I/O components within the system, which are typically provided by a Super I/O controller. Furthermore, it can be used to interface firmware hubs, Trusted Platform Module (TPM) devices and embedded controller solutions. Data transfer on the LPC bus is implemented over a 4 bit serialized data interface, which uses a 33MHz LPC bus clock. For more information about LPC bus refer to the Intel® Low Pin Count Interface Specification Revision 1.1'. The table below indicates the pin functions of the LPC connector.

Pin	Assignment	Pin	Assignment
1	CLK	2	L_AD1
3	RST#	4	L_AD0
5	FRAME#	6	VCC3
7	LAD3	8	GND
9	LAD2	10	---
11	SERIRQ	12	GND
13	5V5B	14	5V

▲ Internal I/O Connectors

Innoage HDD Power (CN37)

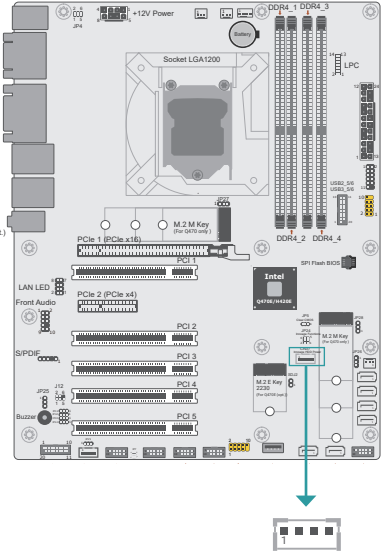

Pin	Assignment
1	+12V_SATA
2	GND
3	GND
4	5V_SATA

▲ Internal I/O Connectors

Expansion Slots

- a PCIe 1 (PCIe x16)
- b PCI1
- c PCIe 2 (PCIe x4)
- d PCI2
- e PCI3
- f PCI4
- g PCI5
- h M.2-M
- i M.2-E
- j M.2-M1

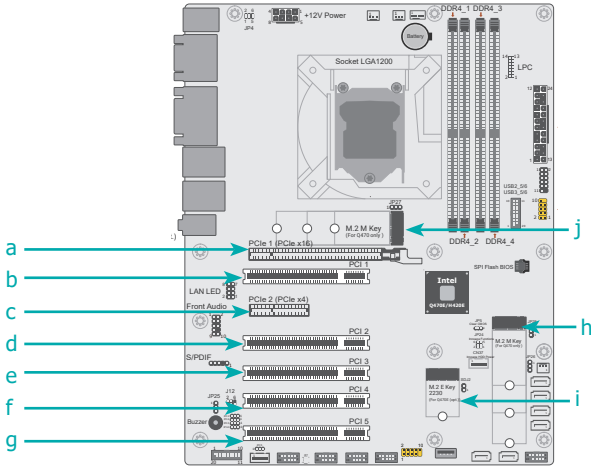

PCI Express x16 Slot

Install a PCI Express x16 graphics card that complies to the PCI Express specifications into the PCI Express x16 slot. To install a graphics card into the x16 slot, align the graphics card to the socket and perpendicularly to the board, be cautious in aligning the locations of notch and key, and then press the card down firmly until it is completely seated. The retaining clip of the slot will close up automatically to hold the graphics card in place.

PCI Express x4 Slots

Install PCI Express cards such as network cards or other expansion cards

PCI Slots

Install PCI cards for other expansion demands.

M.2 Socket

The M.2 socket is the Next Generation Form Factor (NGFF) which is designed to support multiple modules and make the M.2 more suitable in application for solid-state storage.

▲ Expansion Slots

Installing the M.2 Module

Before installing the M.2 module into the M.2 socket, please make sure that the following safety cautions are well-attended.

1. Make sure the PC and all other peripheral devices connected to it has been powered down.
2. Disconnect all power cords and cables.
3. Locate the M.2 socket on the system board
4. Make sure the notch on card is aligned to the key on the socket.
5. Make sure the standoff screw is removed from the standoff.

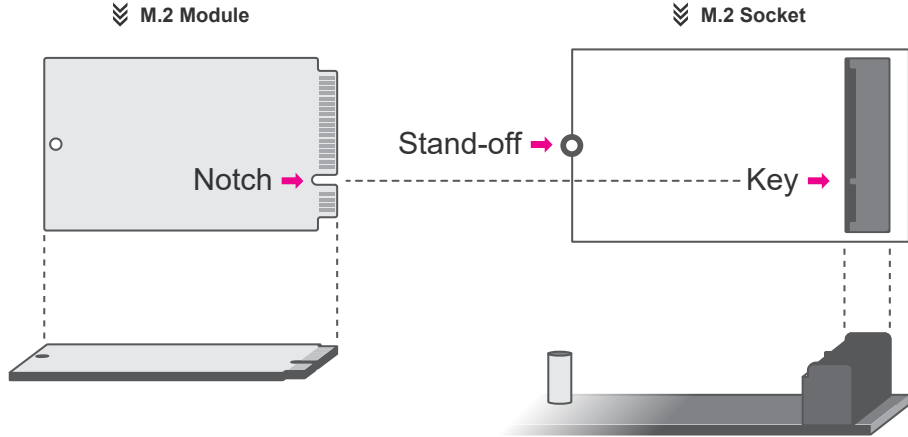



▲ Internal I/O Connectors

Battery

Please follow the steps below to install the card into the socket.

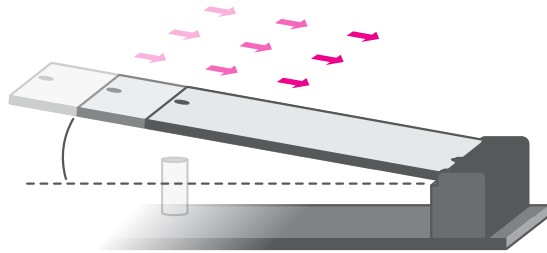

**Step 1:**  
 Insert the card into the socket at an angle while making sure the notch and key are perfectly aligned.

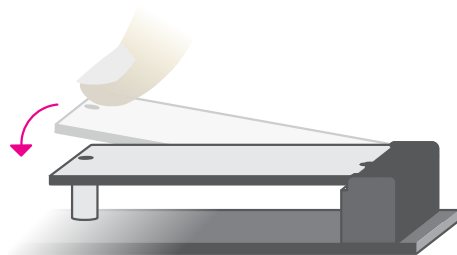

**Step 2:**  
 Press the end of the card far from the socket down until against the stand-off.

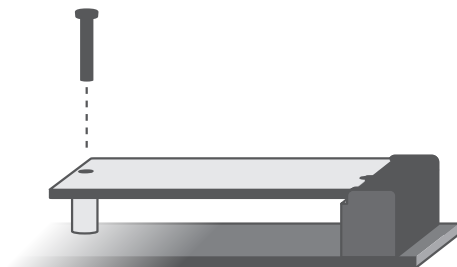

**Step 3:**  
 Screw tight the card onto the stand-off with a screw driver and a stand-off screw until the gap between the card and the stand-off closes up. The card should be lying parallel to the board when it's correctly mounted.

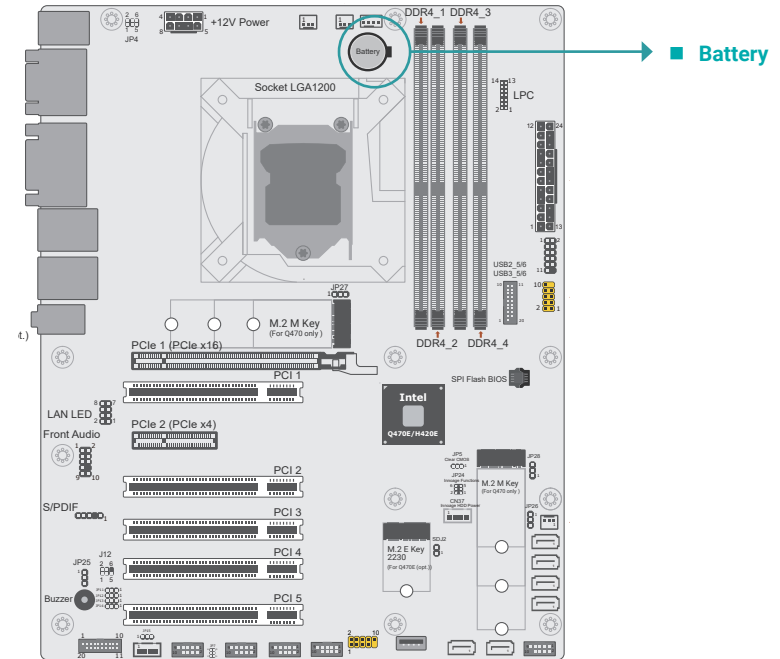

The lithium ion battery addendum supplies power to the real-time clock and CMOS memory as an auxiliary source of power when the main power is shut off. Insert a coin cell battery into the holder and make sure the polarities are correctly oriented – the cap side (rimmed rounded edge) is negative and should be facing the holder; the flat side with a + mark is positive and should be facing away from the holder.

**Safety Measures**

- There exists explosion hazard if the battery is incorrectly installed.
- Replace only with the same or equivalent type recommended by the manufacturer.
- Dispose of used batteries according to local ordinances.

## Chapter 4 - BIOS Settings

### ▲ Overview

The BIOS is a program that takes care of the basic level of communication between the CPU and peripherals. It contains codes for various advanced features found in this system board. The BIOS allows you to configure the system and save the configuration in a battery-backed CMOS so that the data retains even when the power is off. In general, the information stored in the CMOS RAM of the EEPROM will stay unchanged unless a configuration change has been made such as a hard drive replaced or a device added. It is possible that the CMOS battery will fail causing CMOS data loss. If this happens, you need to install a new CMOS battery and reconfigure the BIOS settings.

**Note:**

The BIOS is constantly updated to improve the performance of the system board; therefore the BIOS screens in this chapter may not appear the same as the actual one. These screens are for reference purpose only.

#### Default Configuration

Most of the configuration settings are either predefined according to the Load Optimal Defaults settings which are stored in the BIOS or are automatically detected and configured without requiring any actions. There are a few settings that you may need to change depending on your system configuration.

#### Entering the BIOS Setup Utility

The BIOS Setup Utility can only be operated from the keyboard and all commands are keyboard commands. The commands are available at the right side of each setup screen. The BIOS Setup Utility does not require an operating system to run. After you power up the system, the BIOS message appears on the screen and the memory count begins. After the memory test, the message "Press DEL to run setup" will appear on the screen. If the message disappears before you respond, restart the system or press the "Reset" button. You may also restart the system by pressing the <Ctrl> <Alt> and <Del> keys simultaneously.

#### Legends

Keys	Function
Right / Left arrow	Move the highlight left or right to select a menu
Up / Down arrow	Move the highlight up or down between submenus or fields
<Enter>	Enter the highlighted submenu
+ (plus key)/F6	Scroll forward through the values or options of the highlighted field
- (minus key)/F5	Scroll backward through the values or options of the highlighted field
<F1>	Display general help
<F2>	Display previous values
<F7>	Popup Boot Device List
<F9>	Optimized defaults
<F10>	Save and Exit
<Esc>	Return to previous menu

#### Scroll Bar

When a scroll bar appears to the right of the setup screen, it indicates that there are more available fields not shown on the screen. Use the up and down arrow keys to scroll through all the available fields.

#### Submenu

When "►" appears on the left of a particular field, it indicates that a submenu which contains additional options are available for that field. To display the submenu, move the highlight to that field and press <Enter>.

## ▲ Main

The Main menu is the first screen that you will see when you enter the BIOS Setup Utility.

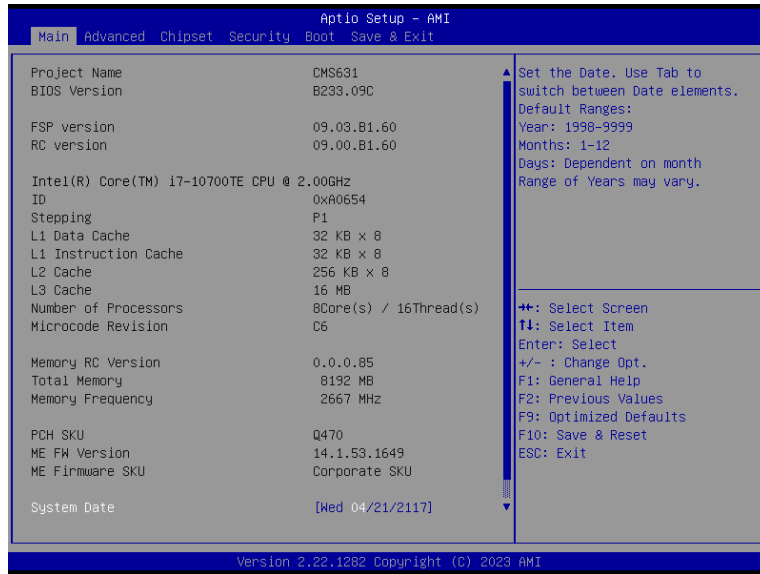

### System Date

The date format is <month>, <date>, <year>. Press "Tab" to switch to the next field and press "-" or "+" to modify the value.

### System Time

The time format is <hour>, <minute>, <second>. The time is based on the 24-hour military-time clock. For example, 1 p.m. is 13:00:00. Hour displays hours from 00 to 23. Minute displays minutes from 00 to 59. Second displays seconds from 00 to 59.

## ▲ Advanced

The Advanced menu allows you to configure your system for basic operation. Some entries are defaults required by the system board, while others, if enabled, will improve the performance of your system or let you set some features according to your preference.



**Important:**  
Setting incorrect field values may cause the system to malfunction.

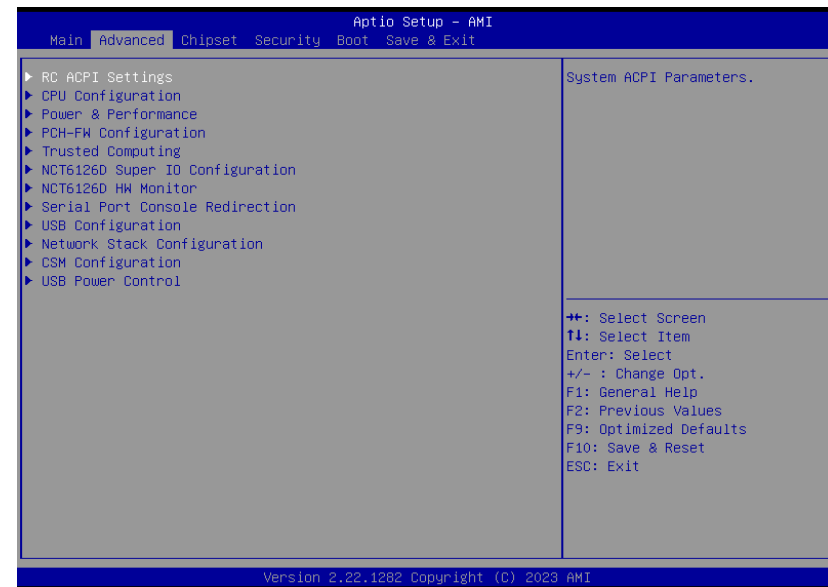

▲ Advanced

## RC ACPI Configuration

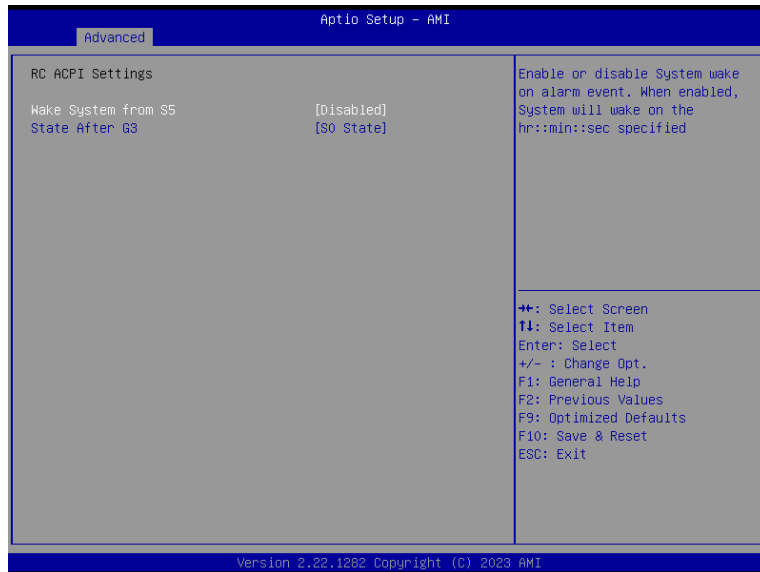

### Wake system from S5 via RTC

When Enabled, the system will automatically power up at a designated time every day. Once it's switched to [Enabled], please set up the time of day — hour, minute, and second — for the system to wake up.

### State After G3

Select between S0 State, and S5 State. This field is used to specify what state the system is set to return to when power is re-applied after a power failure (G3 state).

- S0 State** The system automatically powers on after power failure.
- S5 State** The system enter soft-off state after power failure. Power-on signal input is required to power up the system.
- Last State** The system returns to the last state right before power failure.

▲ Advanced

## CPU Configuration



### Intel (VMX) Virtualization Technology

When this field is set to Enabled, the VMM can utilize the additional hardware capabilities provided by Vanderpool Technology.

### Active Processor Cores

Select number of cores to enable in each processor package: all or 1.

### Hyper-threading

Enables this field for Windows XP and Linux which are optimized for Hyper-Threading technology. Select disabled for other OSes not optimized for Hyper-Threading technology. When disabled, only one thread per enabled core is enabled.

▲ Advanced

Power & Performance

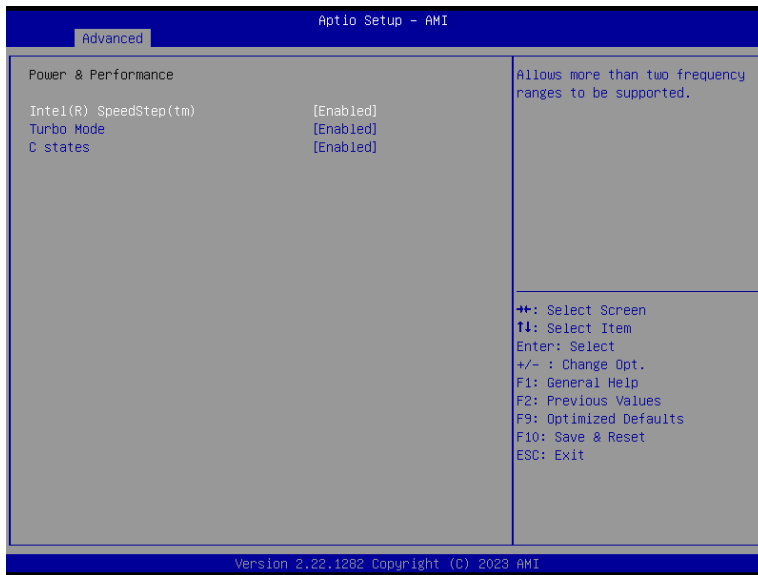

**Intel (R) SpeedStep(tm)**

This field is used to enable or disable the Intel SpeedStep® Technology, which helps optimize the balance between system's power consumption and performance. After it is enabled in the BIOS, EIST features can then be enabled via the operating system's power management.

**Turbo Mode**

Enable or disable turbo mode of the processor. This field will only be displayed when EIST is enabled.

**C states**

Enable or disable CPU Power Management. It allows CPU to enter "C states" when it's idle and nothing is executing.

▲ Advanced

PCH-FW Configuration

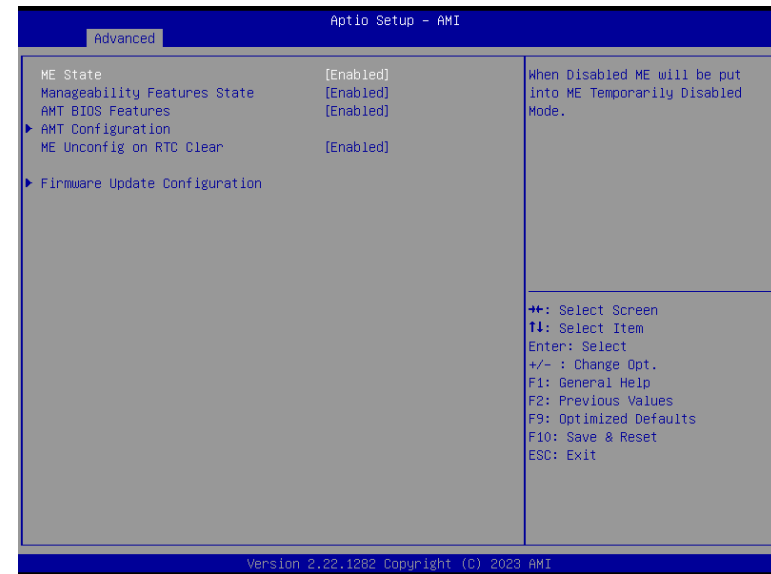

**ME State**

When this field is set to Disabled, ME will be put into ME Temporarily Disabled Mode.

**Manageability Features State**

Enable or disable Intel(R) Manageability features. This option disables/enables Manageability Features support in FW. To disable, support platform must be in an unprovisioned state first.

**AMT BIOS Features**

When disabled, AMT BIOS features are no longer supported and user is no longer able to access MEBx Setup. This option does not disable manageability features in FW.

**AMT Configuration**

Configure Intel(R) Active Management Technology Parameters.

**ME Unconfig on RTC Clear**

When disabled, ME will not be unconfigured on RTC Clear.

**Firmware Update Configuration**

Configure Management Engine Technology Parameters.

▲ Advanced

Trusted Computing



**Security Device Support**

This field is used to enable or disable BIOS support for the security device such as an TPM 2.0 to achieve hardware-level security via cryptographic keys.

**Pending operation**

To clear the existing TPM encryption, select "TPM Clear" and restart the system. This field is not available when "Security Device Support" is disabled.

▲ Advanced

NCT6126D Super IO Configuration

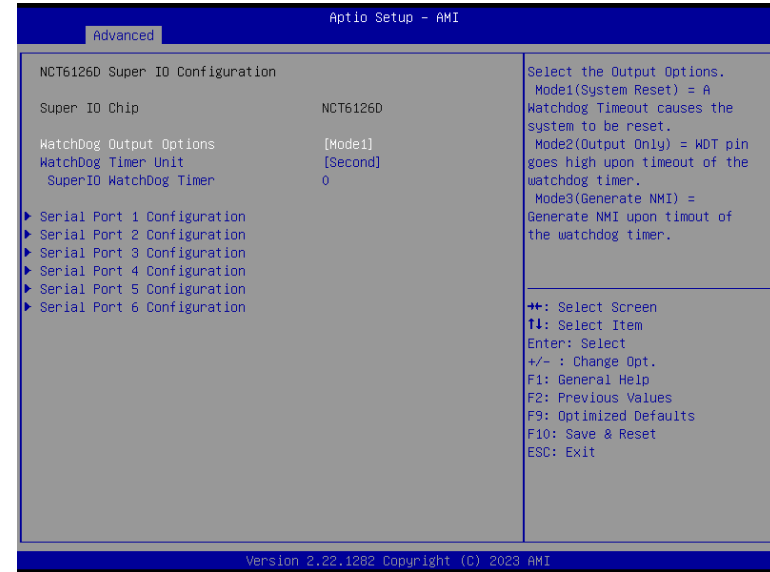

**WatchDog Output Options**

Select The Output Options.  
 Mode1 (System Reset) = A Watchdog Timeout causes the system to be reset.  
 Mode2 (Output Only) = WDT pin goes high upon timeout of the watchdog timer.  
 Mode3 (Generate NMI) = Generate NMI upon timeout of the watchdog timer.

**WatchDog Timer Unit**

Select WatchDog Timer Unit – Second or Minute.

**SuperIO WatchDog Timer**

Set SuperIO WatchDog Timer Timeout value. The range is from 0 (disabled) to 255.



**Note:**  
The sub-menus are detailed in following sections.

▲ Advanced

NCT6126D Super IO Configuration ▶ Serial Port 1,2 Configuration

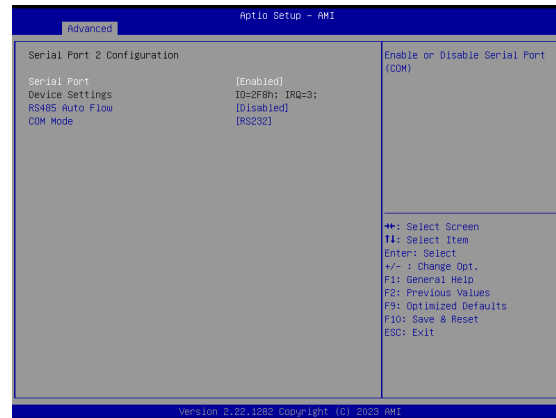
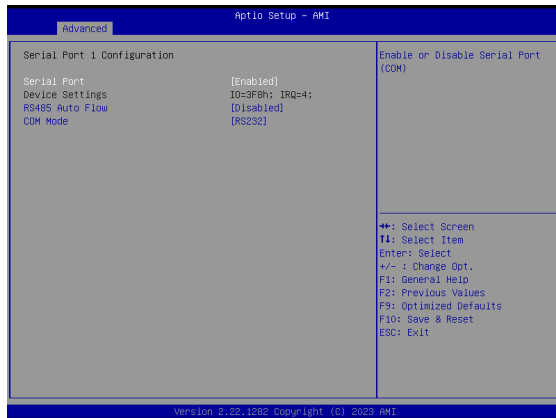

**Serial Port**

Enable or disable serial port.

**RS485 Auto Flow**

Set Serial RS485 Auto Flow.

**COM Mode**

Choose mode between RS232 / RS485 / RS422

▲ Advanced

NCT6126D Super IO Configuration ▶ Serial Port 3,4 Configuration



**Serial Port**

Enable or disable serial port.

▲ Advanced

NCT6126D Super IO Configuration ▶ Serial Port 5,6 Configuration

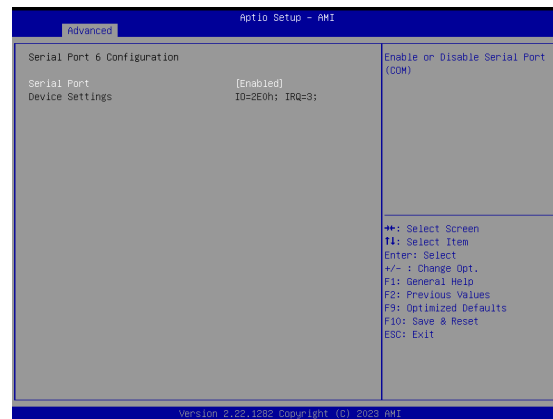

**Serial Port**

Enable or disable serial port.

▲ Advanced

NCT6126D HW Monitor

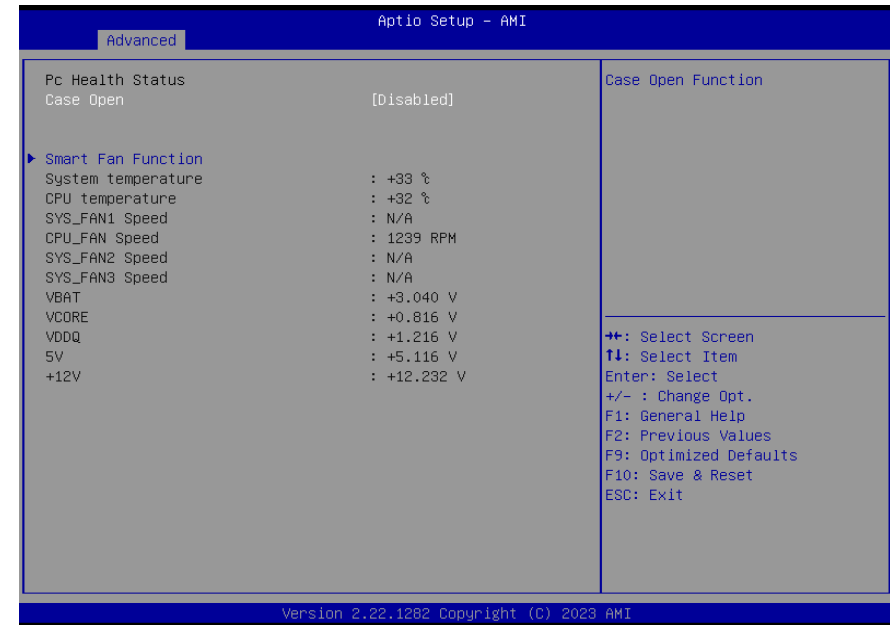

This section displays the system's health information, i.e. voltage readings, CPU and system temperatures, and fan speed readings



▲ Advanced

NCT6126D HW Monitor ► Smart FAN Function

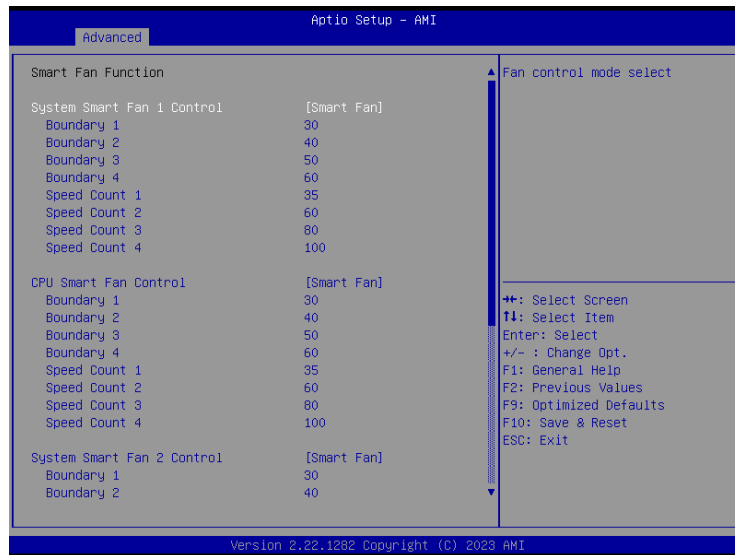

Smart Fan is a fan speed moderation strategy dependent on the current system temperature. When the system temperature goes higher than the Boundary setting, the fan speed will be turned up to the setting of the Fan Speed Count that bears the same index as the Boundary field.

**SYS Smart Fan/CPU Smart Fan Control = [Enabled]**

• **Boundary 1 to Boundary 4**

Set the boundary temperatures that determine the fan speeds accordingly, the value ranging from 0-127°C. For example, when the system temperature reaches Boundary 1 setting, the fan speed will be turned up to the designated speed of the Fan Speed Opt. 1 field.

• **Fan Speed Count 1 to Fan Speed Count 4**

Set the fan speed, the value ranging from 1-100%, 100% being full speed. The fans will operate according to the specified boundary temperatures above-mentioned.

**SYS Smart Fan/CPU Smart Fan Control = [Disabled]**

• **Fix Fan Speed Count**

Set the fan speed, the value ranging from 1-100%, 100% being full speed. The fans will always operate at the specified speed regardless of gauged temperatures.

▲ Advanced

Serial Port Console Redirection

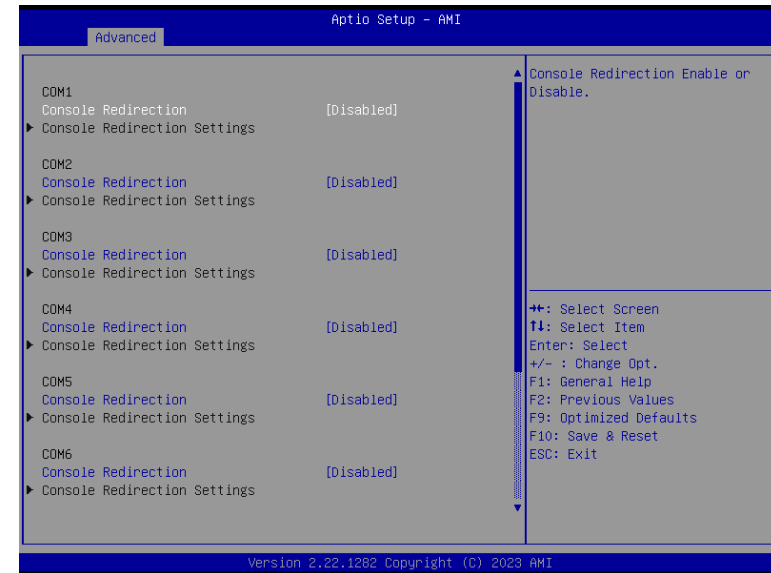

**Console Redirection**

Console Redirection Enable or Disable.

**Console Redirection Settings**

See following pages.

▲ Advanced

Serial Port Console Redirection ► Console Redirection Settings



Configure the serial settings of the current COM port.

**Terminal Type**

Select terminal type: VT100, VT100+, VT-UTF8 or ANSI.

**Bits per second**

Select serial port transmission speed: 9600, 19200, 38400, 57600 or 115200.

**Data Bits**

Select data bits: 7 bits or 8 bits.

**Parity**

Select parity bits: None, Even, Odd, Mark or Space.

**Stop Bits**

Select stop bits: 1 bit or 2 bits.

**Flow Control**

Select flow control type: None or RTS/CTS.

▲ Advanced

USB Configuration

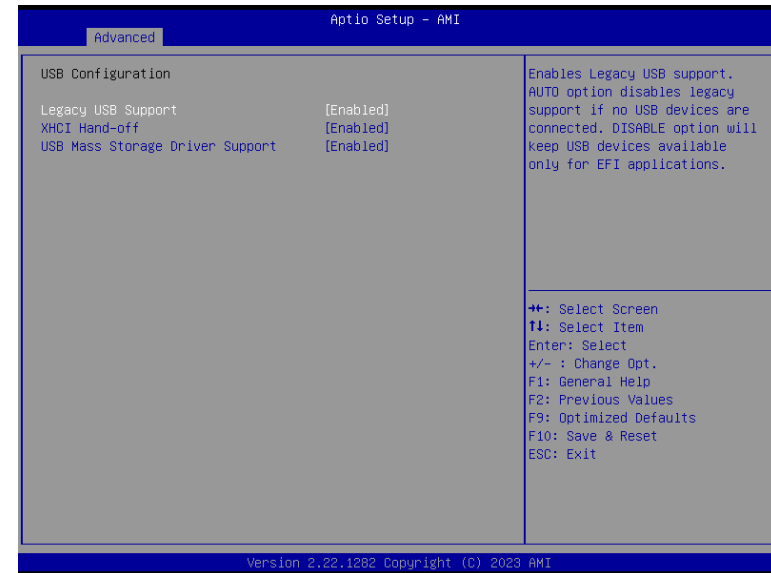

**Legacy USB Support**

- **Enabled** Enable Legacy USB support.
- **Disabled** Keep USB devices available only for EFI applications.
- **Auto** Disable Legacy support if no USB devices are connected.

**XHCI Hand-off**

Enable or disable XHCI Hand-off.

**USB Mass Storage Driver Support**

Enable or disable USB Mass Storage Driver Support.

▲ Advanced

## Network Stack Configuration

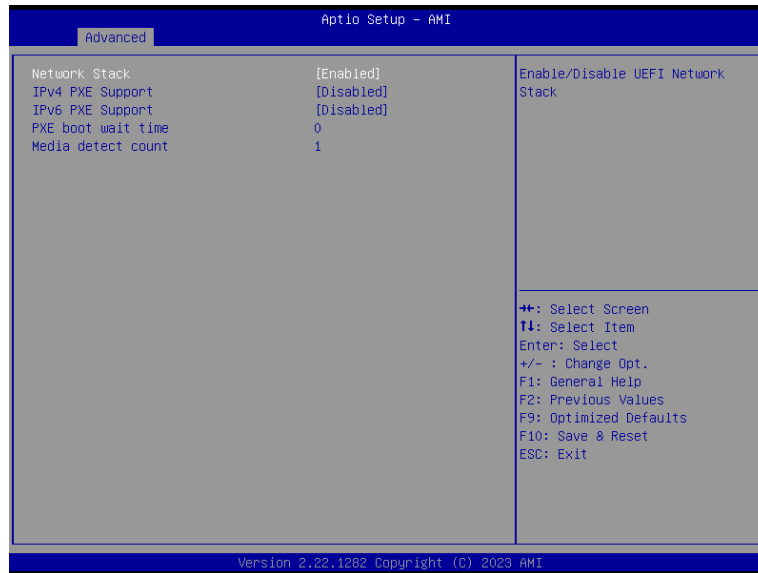

### Network Stack

Enable or disable (Default) UEFI network stack. The following fields will appear when this field is enabled.

**IPv4 PXE Support** Enable or disable IPv4 PXE boot support. If disabled, IPv4 PXE boot support will not be available.

### IPv6 PXE Support

Enable or disable IPv6 PXE boot support. If disabled, IPv6 PXE boot support will not be available.

### PXE boot wait time

Set the wait time in seconds to press ESC key to abort the PXE boot. Use either +/- or numeric keys to set the value.

### Media detect count

Set the number of times the presence of media will be checked. Use either +/- or numeric keys to set the value.

▲ Advanced

## CSM Configuration

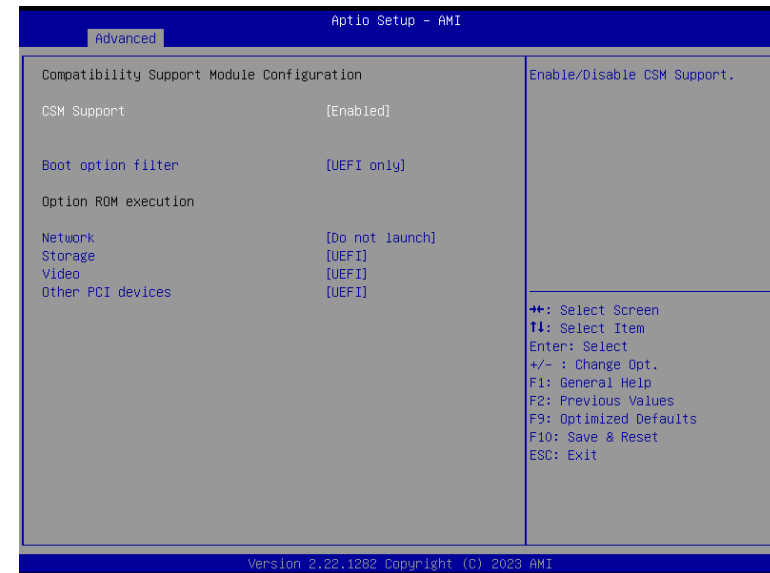

### CSM (Compatibility Support Module) Support

Enable or disable CSM Support.

### Boot option filter

This option controls Legacy/UEFI ROMs priority.

### Network

Controls the execution of UEFI and Legacy Network OpROM

### Storage

Controls the execution of UEFI and Legacy Storage OpROM

### Video

Controls the execution of UEFI and Legacy Video OpROM

### Other PCI devices

Determines OpROM execution policy for devices otherthan Network, Storage, or Video.

▲ **Advanced**

**USB Power Control**

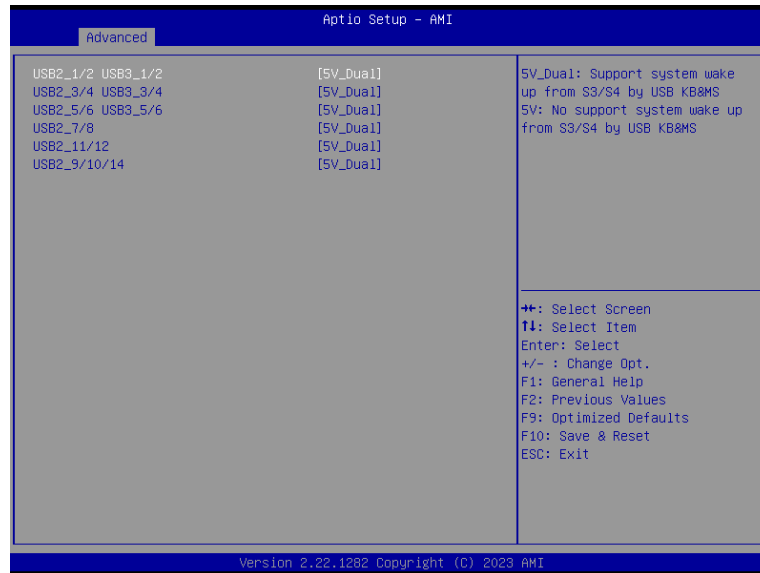

**USB Power**

5V\_Dual: Support system wake from S3/S4 by USB KB&MS

5V: No Support system wake from S3/S4 by USB KB&MS

▲ Chipset

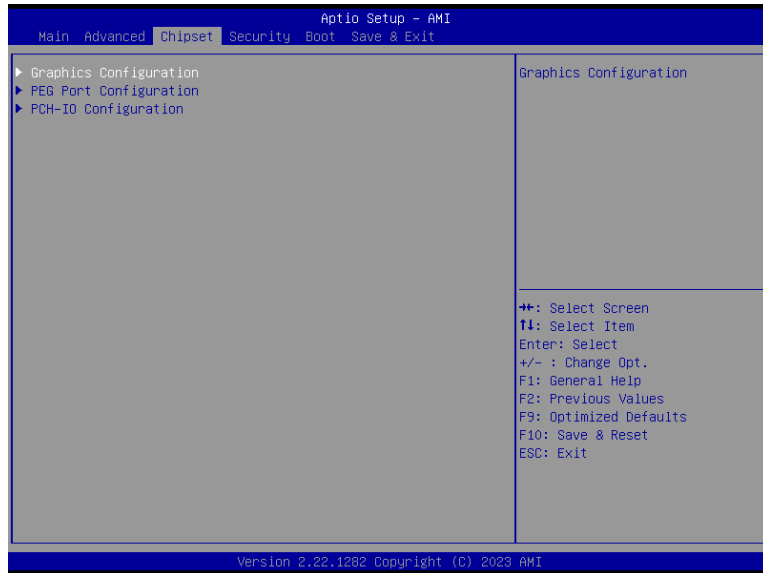

▲ Chipset

Graphics Configuration

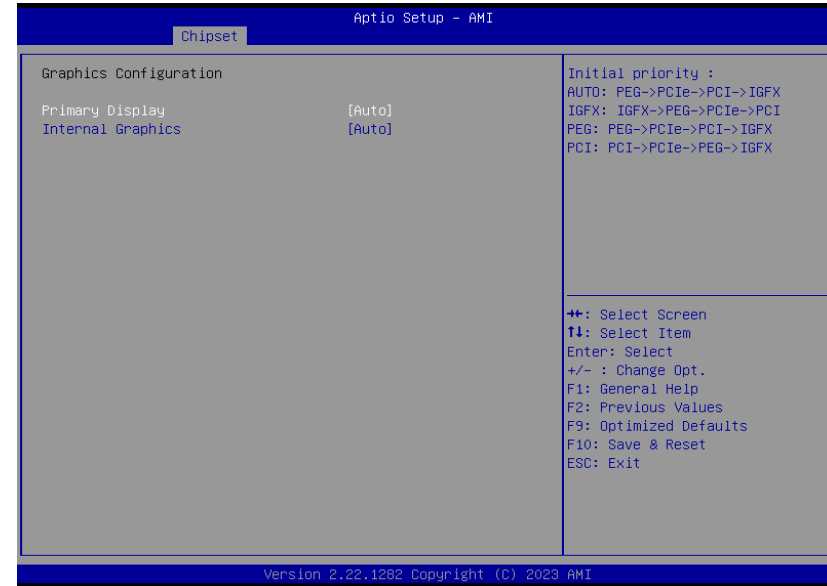

**Primary Display**

Select which of IGFX/PEG/PCI Graphics device to be the primary display.

**Internal Graphics**

Keep IGFX "Enabled" or "Disabled" based on the setup options, or select "Auto" for auto-detection.

▲ Chipset

PEG Port Configuration

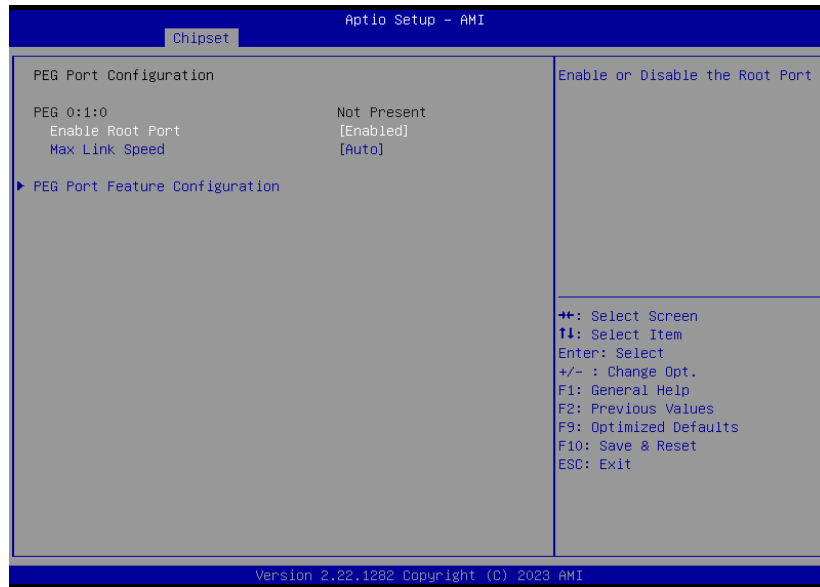

**Enable Root Port**

Enable/Disable the Root Port

**Max Link Speed**

Configure PEG 0:1:0 Max Speed

▲ Chipset

PEG Port Configuration ► PEG Port Feature Configuration

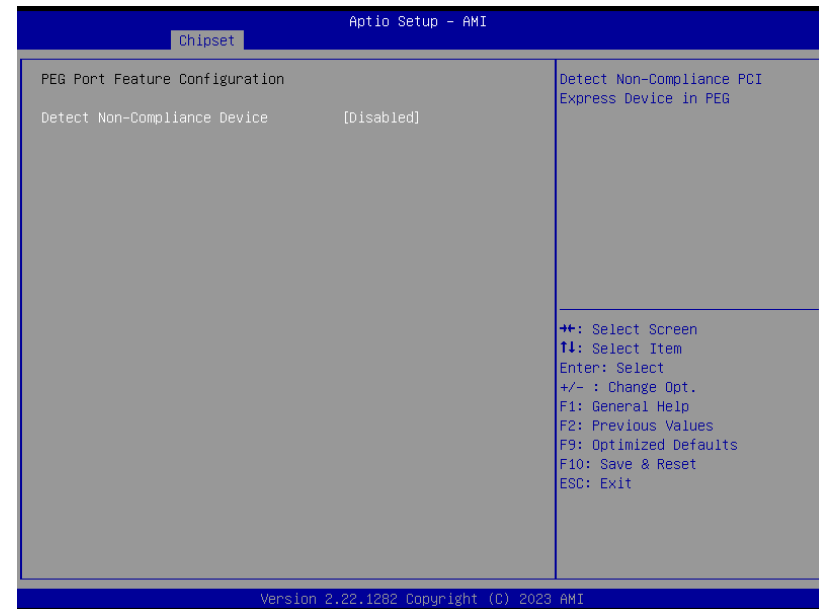

**Detect Non-Compliance Device**

Detect Non-Compliance PCI Express Device in PEG

▲ Chipset

PCH-IO Configuration

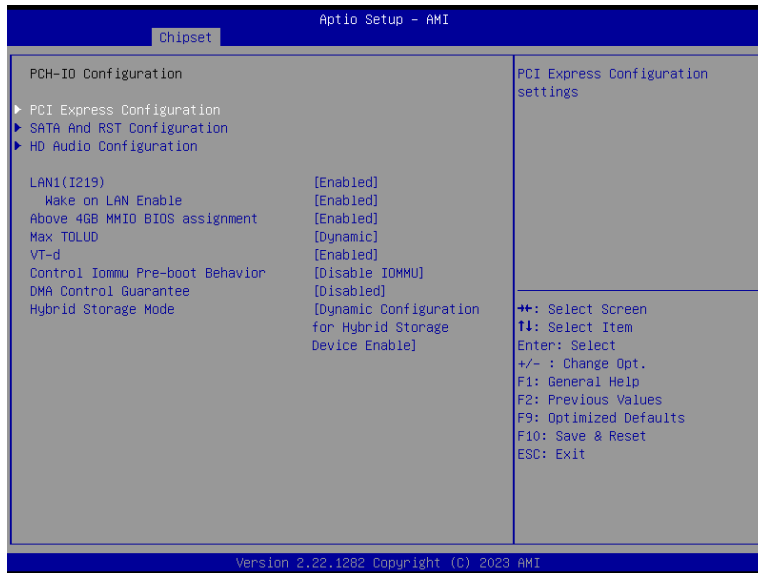

**PCI Express Configuration**

PCI Express Configuration Settings

**SATA And RST Configuration**

SATA Device Options Settings

**HD Audio Configuration**

HD Audio Subsystem Configuration Settings

**LAN1(I219)**

Enable or disable onboard NIC.

**Wake on LAN Enable**

Enable or disable integrated LAN to wake the system.

**Above 4GB MMIO BIOS assignment**

Enable/Disable above 4GB MemoryMappedIO BIOS assignment. This is enabled automatically when Aperture Size is set to 2048MB.

**Max TOLUD**

Assign the maximum value of Top Of Lower Usable DRAM (TOLUD). Select to specify a fixed value, or select "Dynamic" so that the assignment would adjust TOLUD automatically based on largest MMIO length of installed graphic controller.

**VT-d**

VT-d capability

**Control Iommu Pre-boot Behavior**

Enable dTBT and PCH USB topology IOMMU in Pre-boot environment (If DMAR table is installed in DXE and If VTD\_INFO\_PPI is installed in PEI. ) TBT tree won't be included in the exception list.

**DMA Control Guarantee**

Enable/Disable DMA\_CONTROL\_GUARANTEE bit.

**Hybrid Storage Mode**

Select Hybrid Storage detection and configuration Mode.

▲ Chipset

PCH-IO Configuration ► PCI Express Configuration

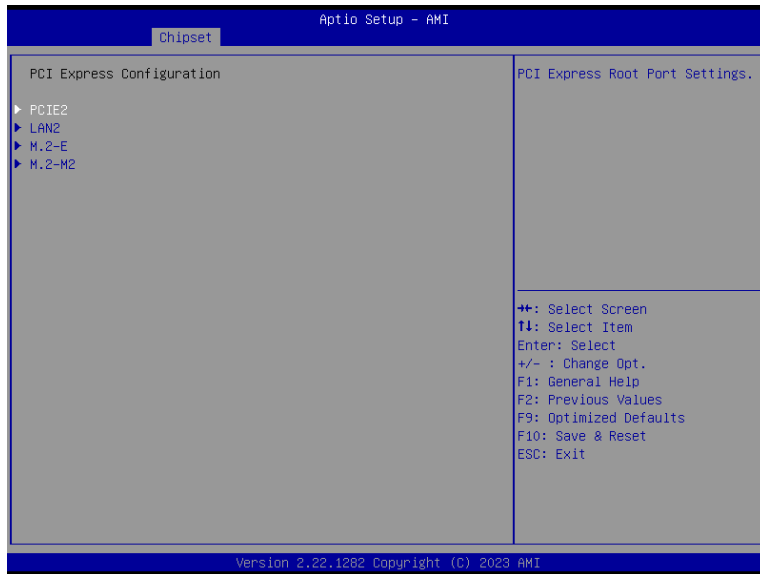

Select one of the PCI Express channels and press enter to configure the following settings.

**LAN 2 & PCIE2, M.2-E, M.2-M2**

Control the PCI Express Root Port.

▲ Chipset

PCH-IO Configuration ► SATA And RST Configuration

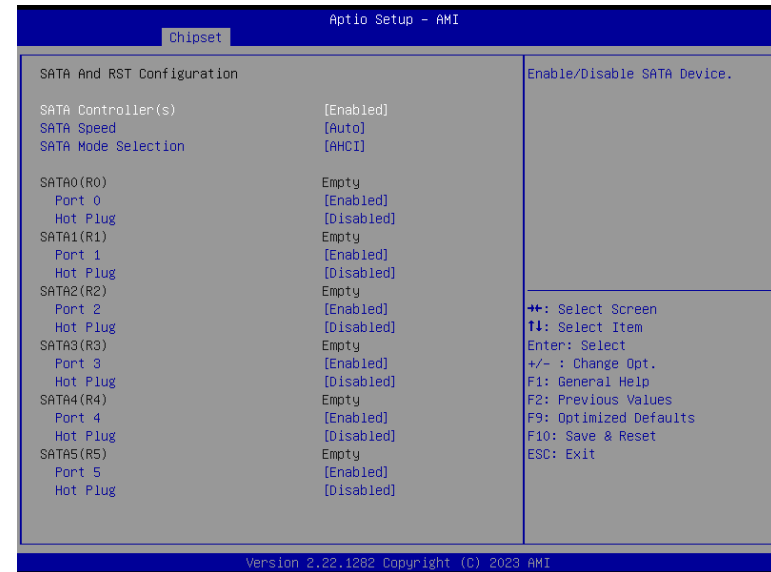

**SATA Controller(s)**

This field is used to enable or disable the Serial ATA controller.

**SATA Speed**

This field is used to select SATA speed generation limit: Auto, Gen1, Gen2 or Gen3.

**SATA Mode Selection**

The mode selection determines how the SATA controller(s) operates.

- **AHCI** This option allows the Serial ATA controller(s) to use AHCI (Advanced Host Controller Interface).
- **Intel RST Premium With Intel Optane System Acceleration** This option allows you to create RAID or Intel Rapid Storage configuration along with Intel® Optane™ system acceleration on Serial ATA devices.

**Ports and Hot Plug**

Enable or disable the Serial ATA port and its hot plug function.



▲ Chipset

PCH-IO Configuration ► HD Audio Configuration

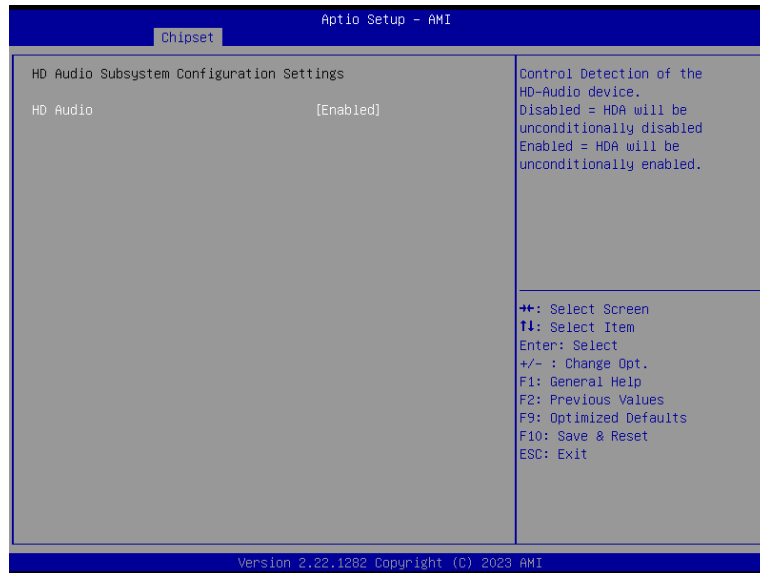

**HD Audio**

Control the detection of the HD Audio device.

**Disabled** HDA will be unconditionally disabled.

**Enabled** HDA will be unconditionally enabled.

▲ Security

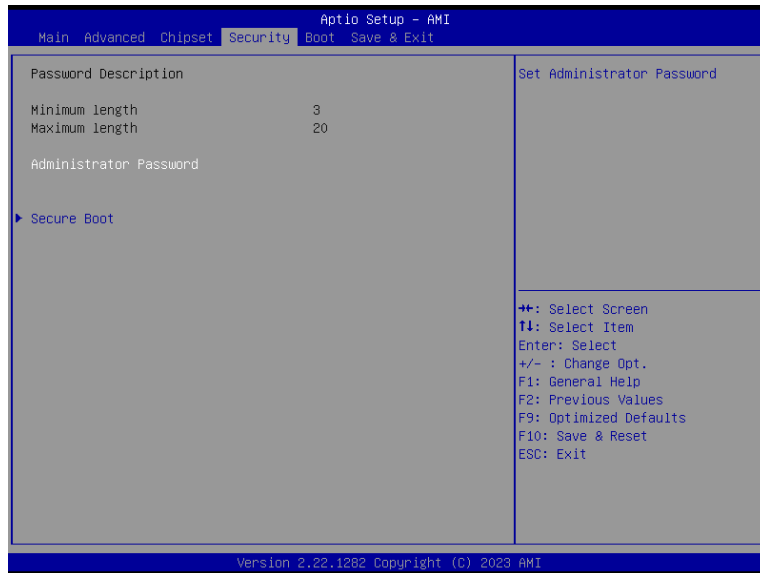

**Administrator Password**

Set the administrator password. To clear the password, input nothing and press enter when a new password is asked. Administrator Password will be required when entering the BIOS.

▲ Security

Secure Boot



**Secure Boot**

Secure Boot feature is Active if secure Boot is Enabled, Platform Key (PK) is enrolled and the system is in user mode. The mode change requires platform reset.

**Secure Boot Mode**

Select the secure boot mode – Standard or Custom. When set to Custom, the following fields will be configurable for the user to manually modify the key database.

**Restore Factory Keys**

Force system to User Mode. Load OEM-defined factory defaults of keys and databases onto the Secure Boot. Press Enter and a prompt will show up for you to confirm.

**Reset To Setup Mode**

Clear the database from the NVRAM, including all the keys and signatures installed in the Key Management menu. Press Enter and a prompt will show up for you to confirm.

## ▲ Boot

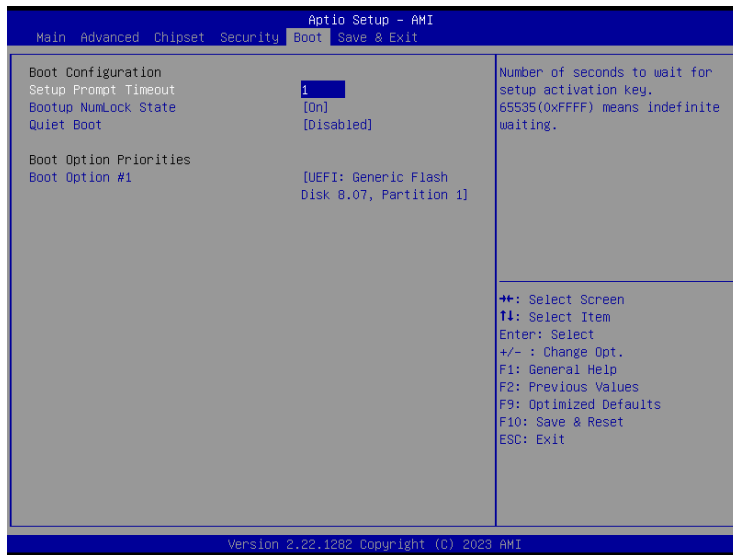

### Setup Prompt Timeout

Set the number of seconds to wait for the setup activation key. 65535 (0xFFFF) denotes indefinite waiting.

### Bootup NumLock State

Select the keyboard NumLock state: On or Off.

### Quiet Boot

This section is used to enable or disable quiet boot option.

### Boot Option Priorities

Rearrange the system boot order of available boot devices.

## ▲ Save & Exit



### Save Changes and Reset

To save the changes, select this field and then press <Enter>. A dialog box will appear. Select Yes to reset the system after saving all changes made.

### Discard Changes and Reset

To discard the changes, select this field and then press <Enter>. A dialog box will appear. Select Yes to reset the system setup without saving any changes.

### Restore Defaults

To restore and load the optimized default values, select this field and then press <Enter>. A dialog box will appear. Select Yes to restore the default values of all the setup options.

### Boot Override

Move the cursor to an available boot device and press Enter, and then the system will immediately boot from the selected boot device. The Boot Override function will only be effective for the current boot. The "Boot Option Priorities" configured in the Boot menu will not be changed.

#### ► Save Setting to file

Select this option to save BIOS configuration settings to a USB flash device.

#### ► Restore Setting from file

This field will appear only when a USB flash device is detected. Select this field to restore setting from the USB flash device.

## ▲ Updating the BIOS

To update the BIOS, you will need the new BIOS file and a flash utility. Please contact technical support or your sales representative for the files and specific instructions about how to update BIOS with the flash utility.

## ▲ Notice: BIOS SPI ROM

1. The Intel® Management Engine has already been integrated into this system board. Due to the safety concerns, the BIOS (SPI ROM) chip cannot be removed from this system board and used on another system board of the same model.
2. The BIOS (SPI ROM) on this system board must be the original equipment from the factory and cannot be used to replace one which has been utilized on other system boards.
3. If you do not follow the methods above, the Intel® Management Engine will not be updated and will cease to be effective.



**Note:**

- a. You can take advantage of flash tools to update the default configuration of the BIOS (SPI ROM) to the latest version anytime.
- b. When the BIOS IC needs to be replaced, you have to populate it properly onto the system board after the EEPROM programmer has been burned and follow the technical person's instructions to confirm that the MAC address should be burned or not.
- c. After updating unique MAC Address from manufacturing, NVM will be protected immediately after power cycle. Users cannot update NVM or MAC address.