



VC500-CMS-MXM

In-Vehicle Edge AI System
User's Manual

Copyright

This publication contains information that is protected by copyright. No part of it may be reproduced in any form or by any means or used to make any transformation/adaptation without the prior written permission from the copyright holders.

This publication is provided for informational purposes only. The manufacturer makes no representations or warranties with respect to the contents or use of this manual and specifically disclaims any express or implied warranties of merchantability or fitness for any particular purpose. The user will assume the entire risk of the use or the results of the use of this document. Further, the manufacturer reserves the right to revise this publication and make changes to its contents at any time, without obligation to notify any person or entity of such revisions or changes.

Changes after the publication's first release will be based on the product's revision. The website will always provide the most updated information.

© 2024. All Rights Reserved.

Trademarks

Product names or trademarks appearing in this manual are for identification purpose only and are the properties of the respective owners.

FCC and DOC Statement on Class A

This equipment has been tested and found to comply with the limits for a Class A digital device, pursuant to Part 15 of the FCC rules. These limits are designed to provide reasonable protection against harmful interference when the equipment is operated in a residential installation. This equipment generates, uses and can radiate radio frequency energy and, if not installed and used in accordance with the instruction manual, may cause harmful interference to radio communications. However, there is no guarantee that interference will not occur in a particular installation. If this equipment does cause harmful interference to radio or television reception, which can be determined by turning the equipment off and on, the user is encouraged to try to correct the interference by one or more of the following measures:

- Reorient or relocate the receiving antenna.
- Increase the separation between the equipment and the receiver.
- Connect the equipment into an outlet on a circuit different from that to which the receiver is connected.
- Consult the dealer or an experienced radio TV technician for help.

Notice:

1. The changes or modifications not expressly approved by the party responsible for compliance could void the user's authority to operate the equipment.
2. Shielded interface cables must be used in order to comply with the emission limits.

Table of Contents

Chapter 1 - Introduction.....	6
Overview.....	6
Front View - 4PoE.....	6
Front View - 4 PoEM12.....	6
Front View - 10G.....	7
Rear View.....	7
Dimensions.....	8
Key Features.....	8
Specifications.....	9
Chapter 2 - Hardware Installations.....	11
Removing the Chassis Cover.....	11
Bottom View.....	11
Left View.....	11
Right View.....	11
Installing an Antenna.....	13
Inserting a 2.5" HDD/SDD.....	14
Installing a 3W3 Adaptor Cable.....	15
Installing the M.2 Module.....	16
Installing the SO-DIMM Module.....	17
Mounting Options.....	18
Wall Mount.....	18
Chapter 3 - System Settings.....	19
Board Layout.....	19
Top View.....	19
Bottom View.....	19
Jumper Settings.....	20
Clear BIOS (JP1).....	20
M.2 Key Power (M2JP2).....	20
M.2 Key Power (M2JP1).....	21
Mini PCIe Power (MPJP1).....	21
USB Power Control (JP24).....	22
DIO Power.....	22
Power On/ Off Control Table (SW3).....	23
Chapter 4 - BIOS Settings.....	24
Overview.....	24
Main.....	25
Advanced.....	25
RC ACPI Settings.....	26
CPU Configuration.....	26
Power & Performance.....	27
PCH-FW Configuration.....	27
Trusted Computing.....	28
NCT6126D Super IO Configuration.....	28
NCT6126D Super IO Configuration ▶ Serial Port 1,2 Configuration	29
NCT6126D Super IO Configuration ▶ Serial Port 3,4 Configuration	29
NCT6126D Super IO Configuration ▶ Serial Port 5,6 Configuration	30
NCT6126D HW Monitor.....	30
NCT6126D HW Monitor ▶ Smart FAN Function	31

Serial Port Console Redirection.....	31
Serial Port Console Redirection ▶ Console Redirection Settings	32
Serial Port Console Redirection ▶ Console Redirection Settings	32
Serial Port Console Redirection ▶ Console Redirection Settings	33
USB Configuration.....	34
Network Stack Configuration.....	34
CSM Configuration.....	35
USB Power Control.....	35
Chipset.....	36
Graphics Configuration.....	36
PEG Port Configuration.....	37
PEG Port Configuration ▶ PEG Port Feature Configuration	37
PCH-IO Configuration.....	38
PCH-IO Configuration ▶ PCI Express Configuration	39
PCH-IO Configuration ▶ SATA And RST Configuration	39
PCH-IO Configuration ▶ HD Audio Configuration	40
Security.....	41
Secure Boot.....	41
Vehicle.....	42
Boot.....	42
Save & Exit.....	43
Updating the BIOS.....	43
Notice: BIOS SPI ROM.....	43

About this Manual

This manual can be retrieved from the website.

The manual is subject to change and update without notice, and may be based on editions that do not resemble your actual products. Please visit our website or contact our sales representatives for the latest editions.

Warranty

1. Warranty does not cover damages or failures that arises from misuse of the product, inability to use the product, unauthorized replacement or alteration of components and product specifications.
2. The warranty is void if the product has been subjected to physical abuse, improper installation, modification, accidents or unauthorized repair of the product.
3. Unless otherwise instructed in this user's manual, the user may not, under any circumstances, attempt to perform service, adjustments or repairs on the product, whether in or out of warranty. It must be returned to the purchase point, factory or authorized service agency for all such work.
4. We will not be liable for any indirect, special, incidental or consequential damages to the product that has been modified or altered.

About this Package

The package contains the following items. If any of these items are missing or damaged, please contact your dealer or sales representative for assistance.

- 1 VC500-CMS-MXM System Unit
- 1 3W3 Adaptor Cable
- 1 Mounting Bracket
- 1 Power Connector

Note: The items are subject to change in the developing stage. The product and accessories in the package may not come similar to the information listed above. This may differ in accordance with the sales region or models in which it was sold. For more information about the standard package in your region, please contact your dealer or sales representative.

Static Electricity Precautions

It is quite easy to inadvertently damage your PC, system board, components or devices even before installing them in your system unit. Static electrical discharge can damage computer components without causing any signs of physical damage. You must take extra care in handling them to ensure against electrostatic build-up.

1. To prevent electrostatic build-up, leave the system board in its anti-static bag until you are ready to install it.
2. Wear an antistatic wrist strap.
3. Do all preparation work on a static-free surface.
4. Hold the device only by its edges. Be careful not to touch any of the components, contacts or connections.
5. Avoid touching the pins or contacts on all modules and connectors. Hold modules or connectors by their ends.



Important:

Electrostatic discharge (ESD) can damage your processor, disk drive and other components. Perform the upgrade instruction procedures described at an ESD workstation only. If such a station is not available, you can provide some ESD protection by wearing an antistatic wrist strap and attaching it to a metal part of the system chassis. If a wrist strap is unavailable, establish and maintain contact with the system chassis throughout any procedures requiring ESD protection.

Safety Precautions

- Use the correct DC / AC input voltage range.
- Unplug the power cord before removing the system chassis cover for installation or servicing. After installation or servicing, cover the system chassis before plugging in the power cord.
- There is danger of explosion if battery incorrectly replaced.
- Replace only with the same or equivalent specifications of batteries recommend by the manufacturer.
- Dispose of used batteries according to local ordinance.
- Keep this system away from humid environments.
- Make sure the system is placed or mounted correctly and stably to prevent the chance of dropping or falling may cause damage.
- The openings on the system shall not be blocked and shall be kept in distance from

other objects to make sure of proper air ventilation to protect the system from over-heating.

- Dress the cables, especially the power cord, so they will not be stepped on, in contact with high temperature surfaces, or cause any tripping hazards.
- Do not place anything on top of the power cord. Use a power cord that has been approved for use with the system and is compliant with the voltage and current ranges required by the system's electrical specifications.
- If the system is to be unused or stored for a long time, disconnect it from the power source to avoid damage by transient overvoltage.
- If one of the following occurs, consult a service personnel:
 - The power cord or plug is damaged.
 - Liquid has penetrated the system.
 - The system has been exposed to moisture.
 - The system is not working properly.
 - The system is physically damaged.
- The unit uses a three-wire ground cable which is equipped with a third pin to ground the unit and prevent electric shock. Do not defeat the purpose of this pin. If your outlet does not support this kind of plug, contact your electrician to replace the outlet.
- Disconnect the system from the electricity outlet before cleaning. Use a damp cloth for cleaning the surface. Do not use liquid or spray detergents for cleaning.
- Before connecting, make sure that the power supply voltage is correct. The device is connected to a power outlet which should be grounded connection.



The system may burn fingers while running.

Wait for 30 minutes to handle electronic parts after power off.

Chapter 1 - Introduction

► Overview

Front View - 4PoE

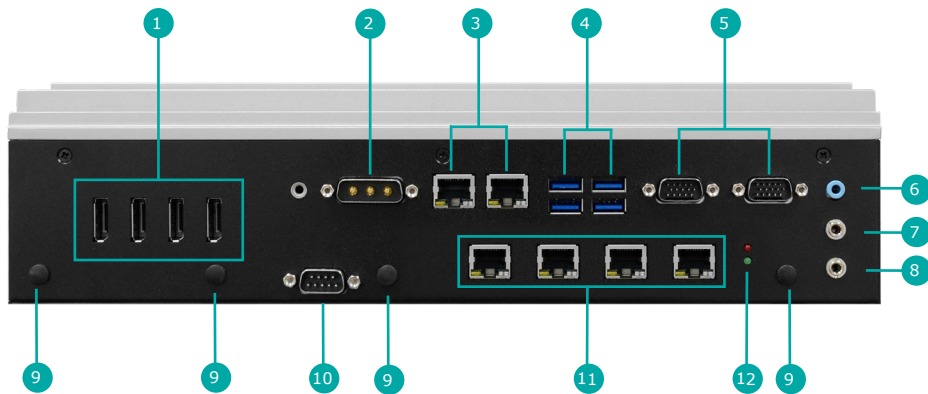

- | | | | |
|---|---------------|----|----------------|
| 1 | Display Ports | 7 | Line-In |
| 2 | 3W3 Connector | 8 | Mic-In |
| 3 | LAN 1/2 | 9 | Antenna Hole |
| 4 | USB 3.1 Gen 2 | 10 | COM5 |
| 5 | DIO | 11 | PoE |
| 6 | Line-Out | 12 | LED Indicators |

Front View - 4 PoEM12

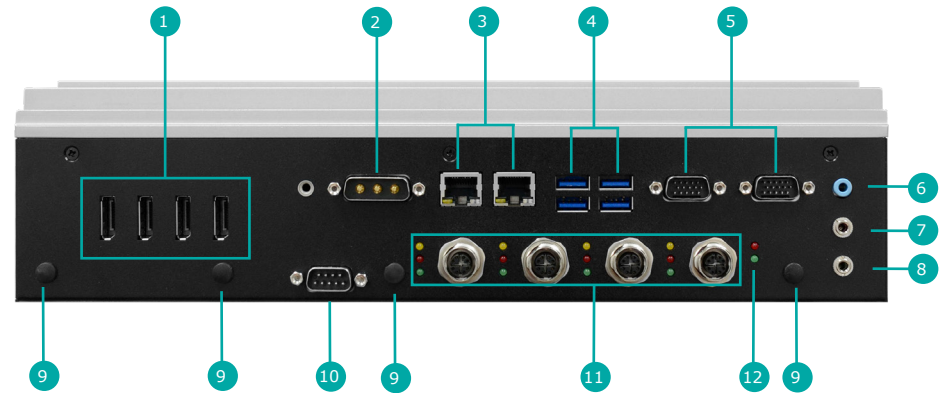

- | | | | |
|---|---------------|----|----------------|
| 1 | Display Ports | 7 | Line-In |
| 2 | 3W3 Connector | 8 | Mic-In |
| 3 | LAN 1/2 | 9 | Antenna Hole |
| 4 | USB 3.1 Gen 2 | 10 | COM5 |
| 5 | DIO | 11 | PoE |
| 6 | Line-Out | 12 | LED Indicators |

Front View - 10G

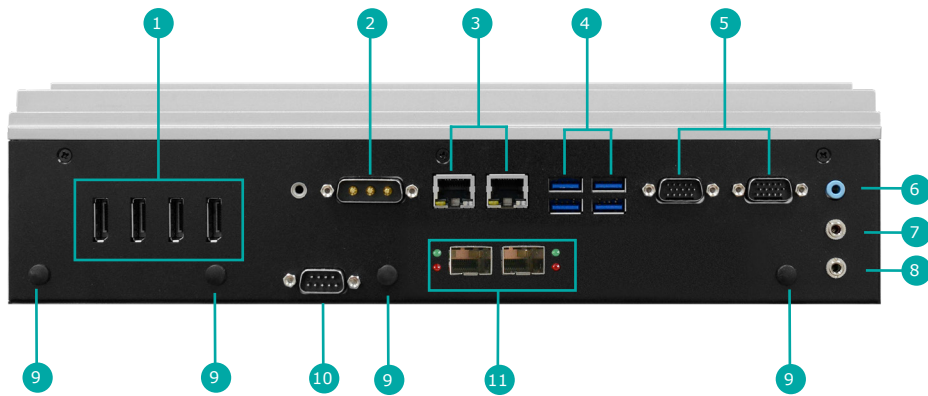

- | | | | |
|---|---------------|----|--------------|
| 1 | Display Ports | 7 | Line-In |
| 2 | 3W3 Connector | 8 | Mic-In |
| 3 | LAN 1/2 | 9 | Antenna Hole |
| 4 | USB 3.1 Gen 2 | 10 | COM5 |
| 5 | DIO | 11 | 10g |
| 6 | Line-Out | | |

Rear View

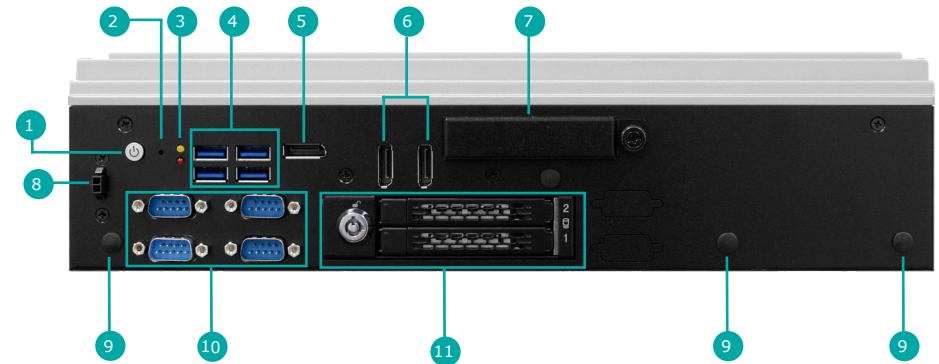

- | | | | |
|---|---|----|----------------------|
| 1 | Power Button | 7 | SIM Slots |
| 2 | Reset Button | 8 | Remote Switch |
| 3 | Power Status LED (Yellow)
Storage Activity LED (Red) | 9 | Antenna Hole |
| 4 | USB 3.1 Gen 2 | 10 | COM 1/2/3/4 |
| 5 | DP++/ HDMI | 11 | 2.5" SATA Drive Bays |
| 6 | DP++ | | |

► Dimensions

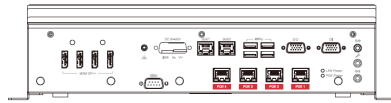

Front View
(4PoE)

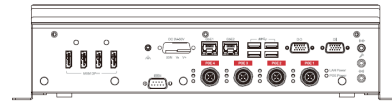

Front View
(4PoEM12)

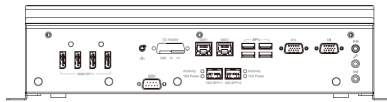

Front View
(10G)

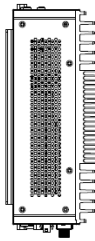

Right View

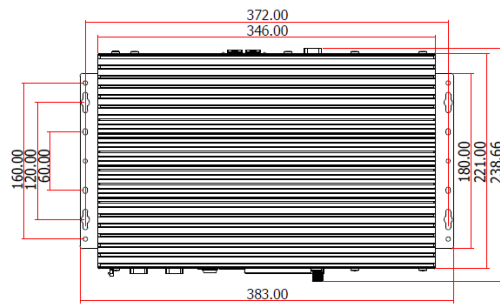

Top View

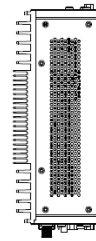

Left View

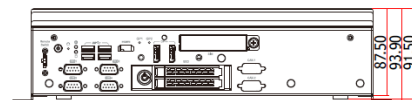

Rear View

► Key Features

High Performance CPU:

10th Gen Intel® Xeon/Core™/Pentium/Celeron Processors

802.11af PoE Ports

4 x RJ45 or M12 X-coded type PoE ports at 15.4W

AI Accelerated

Support MXM GPU module

Multiple Expansions:

1 x miniPCIe and 4x M.2 slots

Dual SIM for single Modem

Two SIM cards for 5G/LTE module

► Specifications

SYSTEM	Processor	10th Gen Intel® Xeon/Core™/Pentium/Celeron Processors, LGA 1200 Socket -Intel® Xeon-1270TE (8 Cores, 16M Cache, up to 2.0/4.4 GHz); 35W -Intel® Core™ i9-10900TE (10 Cores, 20M Cache, up to 1.8/4.5 GHz); 35W -Intel® Core™ i7-10700TE (8 Cores, 16M Cache, up to 2.0/4.4 GHz); 35W -Intel® Core™ i5-10500TE (6 Cores, 12M Cache, up to 2.3/3.7 GHz); 35W -Intel® Core™ i3-10100TE (4 Cores, 6M Cache, to 2.3/3.6 GHz); 35W
	Chipset	Intel® Q470E/ W480E
	Memory	Dual SO-DIMM slots (horizontal type) with anti-vibration bracket Dual Channel DDR4 2933/2666/2400/2133 SDRAM, up to 64GB ECC support for Xeon-1270TE processor only
	BIOS	AMI SPI 256Mbit
GRAPHICS	Controller	Intel® processor integrated or Independent MXM module by BIOS selection
	Compatible MXM	Type A or B MXM modules: RTX A2000, RTX3000, A500, A1000
	Display	4 x Display Ports with lock holes from MXM 1 x HDMI combo port and 2 x DP++ ports from CPU
STORAGE	External	2 x swappable 2.5" SATA drive bays with lock on rear panel Supports RAID 0/1
	Internal	1 x M.2 2280 M Key slot, supports 2242, 2260 & 2280 devices PCIe x4 & SATA signal, support boot up function
	Interface	SATA
AUDIO	Audio Codec	Realtek ALC888
	Interface	1 x Mic-in and 1 x Line-in
ETHERNET	Controller	1 x Intel® i219LM with iAMT11.0 support (Core i7/i5 only) 1 x Intel® i210IT
LED	Indicators	1 x Storage Activity (Red) 1 x Power (Green) 2 x Programmable general purpose (Green, Blue)
FRONT I/O	Ethernet	2 x RJ45 GbE ports
	PoE/ 10G	4 x 802.11af PoE ports at RJ45 or M12 X-coded connectors, max 15.4W (PSE side) or 2 x 10G fiber ports at SFP+ cage based on Intel X710-BM2 Ethernet controller
	Serial	1 x DB-9 RS232 ports (COM 5)
	USB	4 x USB 3.1 Gen2
	DIO	2 x Isolated DIO port by 2 x DB-15 female connectors Supports 8bit DI & 8 bit DO with 2KV isolation
	Audio	1x Line-out, 1 x Mic-in and 1x Line-in with 3.5mm audio jacks
	Antenna	2 x antenna holes
	DC in	W3 3 pin connector
	OOB	Optional RJ45 port for OOB management

REAR I/O	Serial	4 x DB-9 RS232/422/485 ports by BIOS selection (COM 1/2/3/4)
	USB	4 x USB 3.1 Gen2
	Display	4 x Display Ports with lock holes from MXM 1 x DP++/HDMI combo port and 2 x DP++ ports from CPU
	Antenna	2 x antenna holes
	SIM slot	3 x accessible SIM slots with cover bracket
	CAN bus	2 x DB-9 ports for CAN bus (optional)
	Remote Switch	2-pin remote switch
	Power Button	1 x Power button
	Reset Button	1 x Reset button
SIDE I/O	Antenna	2 x antenna holes on right side 2 x antenna holes on left side
INTERNAL I/O	Serial	1 x 2x5 pin block header for RS232
	Mini PCIe slot	1 x mini PCIe slot with SIM holer on faceplate Supports WiFi/BT/LTE or CAN bus module
	M.2 Slot	Total 3 x M.2 slots 1 x 2230 E-key slot (PCIe x1 & USB2.0) 1 x 3042/3052 B-Key (USB3.0 & PCIe x1) with dual SIM slots on faceplate 1 x 2242/2280 M-Key-slot (PCIe gen3 x4 & SATA) supporting Intel® Optane memory (Both of the M10 and H10) and NVMe
COOLING	FAN	Passive cooling by default Optional Fan cooling upon request
HARDWARE MONITOR	Gravity Sensor	Support 3-axis femto accelerometer User-selectable $\pm 2g/\pm 4g/\pm 8g/\pm 16g$ scale Supports 6D/4D orientation detection, Free-fall detection, Motion detection and leap-to- wake and return-to-sleep
SECURITY	TPM	Supports dTPM2.0 by default (disabled by BIOS setting) Optional fTPM2.0 supported
POWER	Type	3pin 3W3 connector
	Supply	Wide Range 9~50VDC with power management (on/off delay) and ignition
OS SUPPORT	Microsoft	Windows 11 IoT Enterprise LTSC SW Windows 10 IoT Enterprise RS5
	Linux	Ubuntu Linux 20.04
MECHANISM	Construction	Metal + Aluminum
	Mounting	Wall mount
	Dimensions (W x H x D)	346mm x 87.55 mm x 221mm
	Weight	6.95 Kg
	Color	Black and Silver
ENVIRONMENT	Operating Temperature	-20°C to 60°C without turbo boost and throttling is expected
	Storage Temperature	-40°C to 85°C
	Relative Humidity	10% to 95% (non-condensing)
STANDARDS AND CERTIFICATIONS	Shock	MIL-STD-810G Method 516.6, Procedure 1, OP:10G 11ms, Non-OP: 40G 11ms (Test by SSD, HDD is not support)
	Vibration	MIL-STD-810G Method 514.6C-3, Category 4 Composite wheeled vehicle Table 514.6C-VI
	Certification	FCC, E-Mark

Chapter 2 - Hardware Installations

► Removing the Chassis Cover

Please observe the following guidelines and follow the instructions to open the system.

1. Make sure the system and all other peripheral devices connected to it have been powered off.
2. Disconnect all power cords and cables.

Step 1:

Turn the system upside down to remove the 4 screws on the bottom. The 12 screws on both left and right sides of the system are used to secure the cover to the chassis. Remove the screws and put them in a safe place for later use.

Bottom View



Left View



Right View

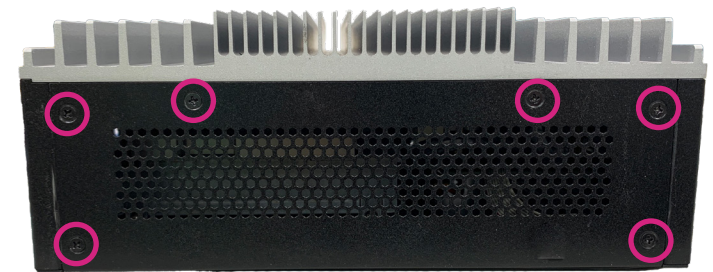

Step 2:

Lift the cover to open the system.

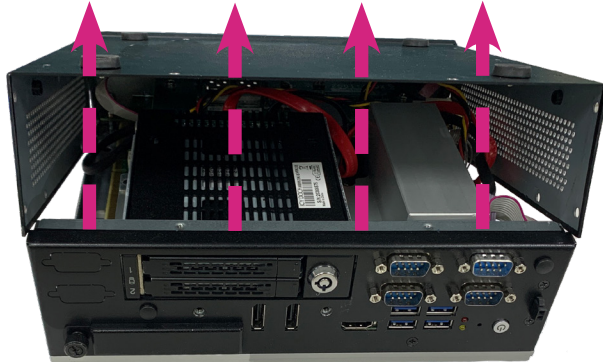

Step 3:

The board can be easily accessed after the chassis cover is removed.

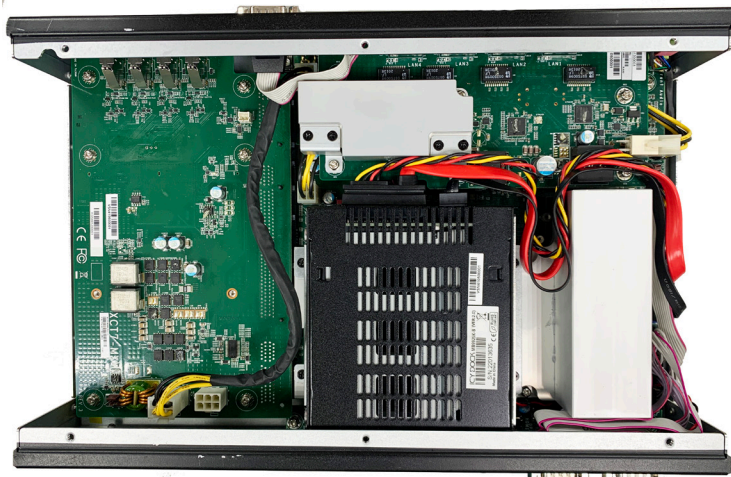

► Installing an MXM Card

Before installing an MXM card, please make sure that the following safety cautions are wellattended.

1. Make sure the PC and all other peripheral devices connected to it has been powered down.
2. Disconnect all power cords and cables.

Step 1:

To locate a MXM card socket, please follow the [Removing the Chassis Cover](#) section and lift the cover to open the system.

Step 2:

Remove the screws/standoffs marked in red circle on the main board.



Step 3:

Turn the machine upside down. Remove the screws/standoffs marked in red circle on the front/rear side of the chassis.

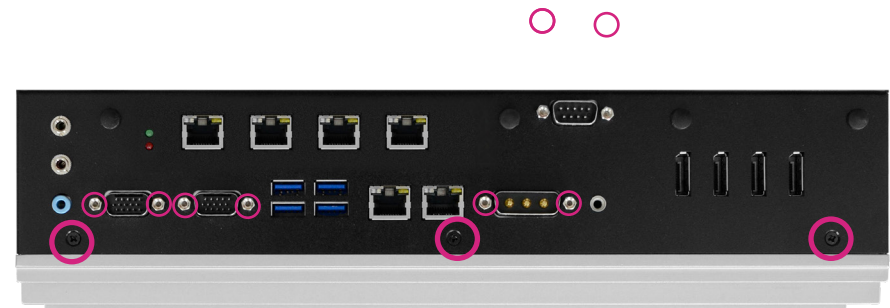

Step 4:

Gently lift the main board and remove all the screws marked in green circle from the MXM board. A MXM card socket is on the back side of the main board.

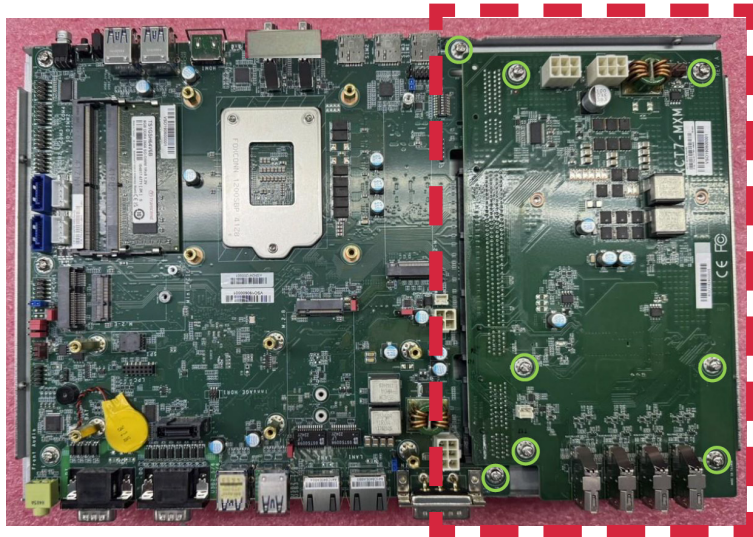

Step 5:

Insert a MXM card into the card socket slightly.
And lock the card with two screws marked in red circle.

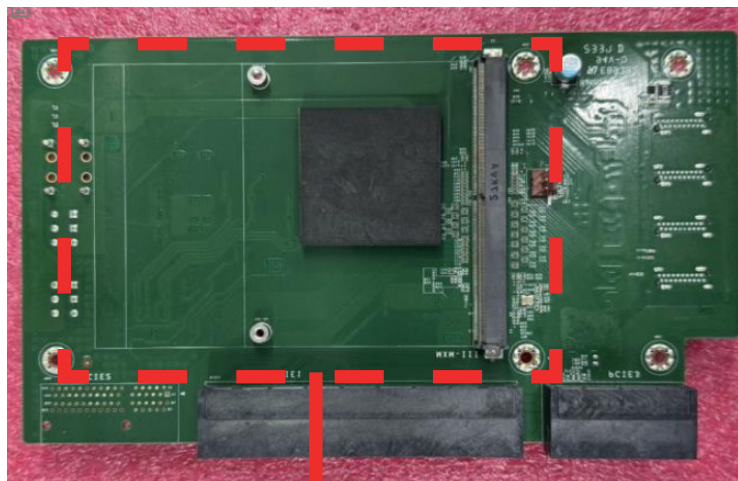
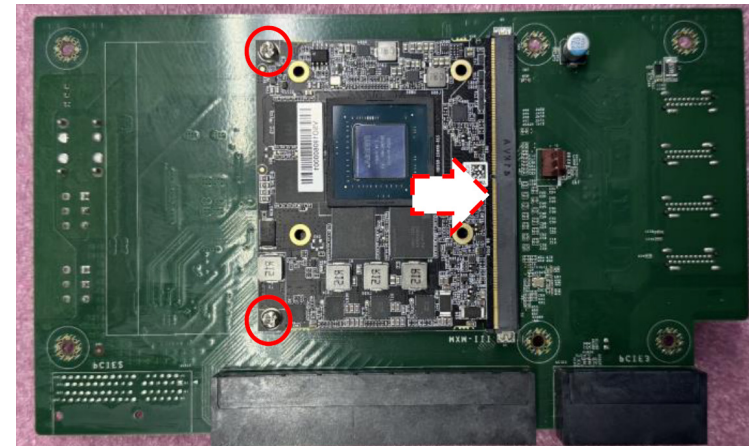

MXM Card Socket



Note:

A heat sink will differ depending on the module of MXM card installed.

► Installing an Antenna

Before installing the antenna, please make sure that the following safety cautions are well-attended.

1. Make sure the PC and all other peripheral devices connected to it has been powered down.
2. Disconnect all power cords and cables.

Step 1:

There are antenna holes reserved on the front and the rear side of the system and covered by rubber plugs. Please remove the plug prior to installing an antenna.



Step 2:

Connect the internal cable to the board's antenna connector, screw the antenna connector through the antenna hole with washers and nuts, and screw on the antenna as illustrated below.

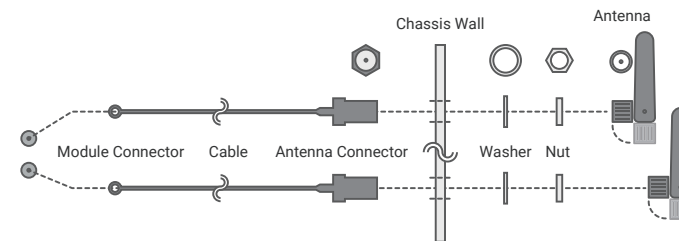

▶ Inserting a 2.5" HDD/SDD

Step 1:

The 2.5" HDD/SDD slots on the front side of the system.
Find the key. Insert the key included inside the package to unlock it.

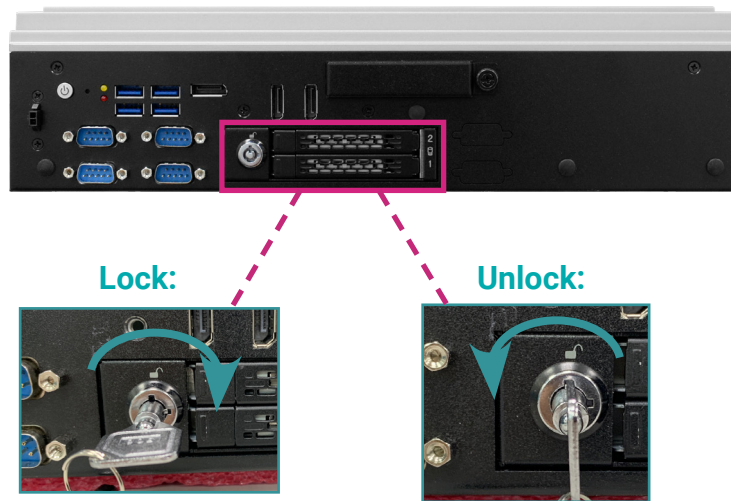

Step 2:

Once unlocked, press in gently the eject button until the tray is released.



Step 3:

Pull the tray out and slide the drive into the slot until the drive is fully seated.



Step 4:

Push the tray back in and close the drive latch to lock the drive in place.



Important:

Excessive force may damage its mechanical parts.
If the HDD/SSD is inserted backward into the slot, forcing the device may damage the slot.

► Installing a 3W3 Adaptor Cable

To assembly a 3W3 adaptor cable, please look at the illustration below for more information.

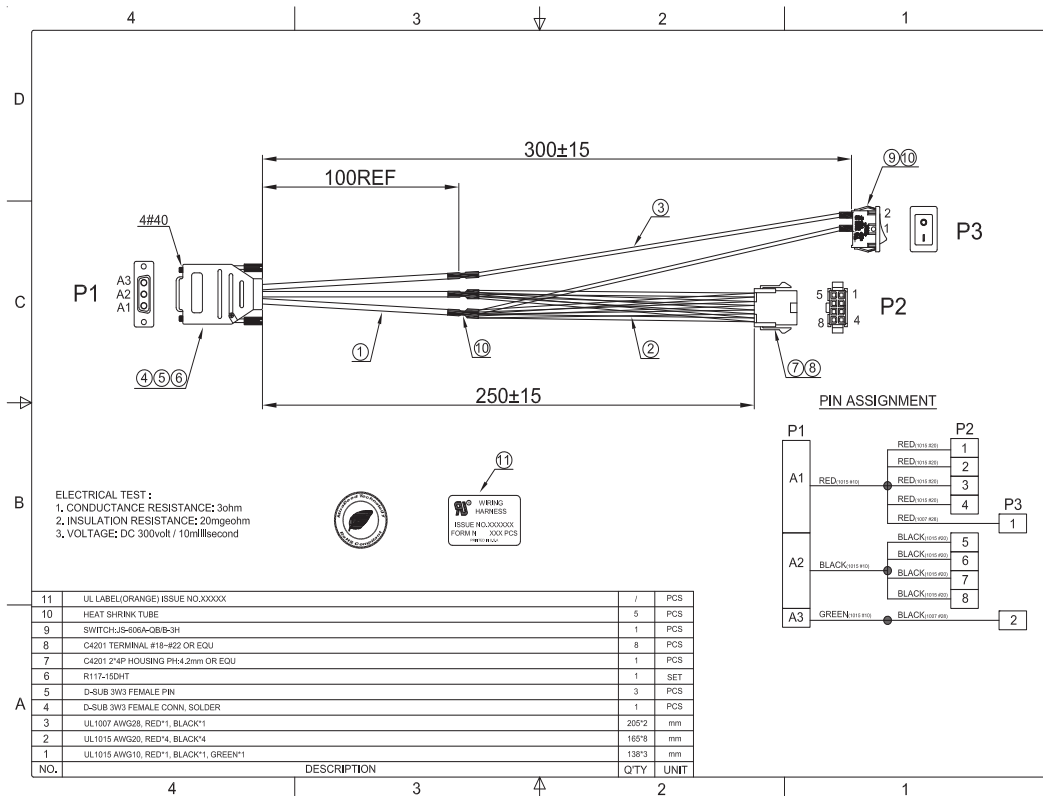

To purchase the accessories below, please contact our local dealer or DFI sales representative for more information.

- 3W3 adaptor cable (with a power switch & an ignition cable)
Part No.: [A81-004363-054G](#)

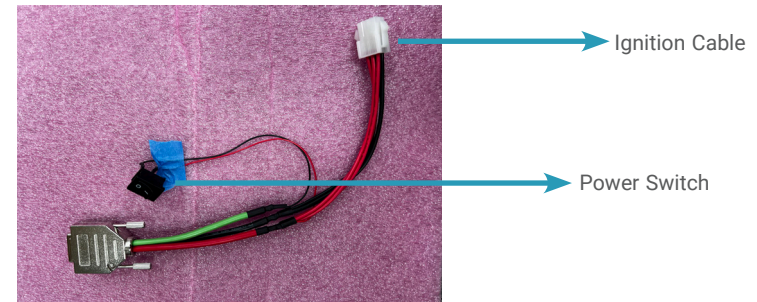

- Power adaptor
Part No.: [671-133001-000G](#)
Spec:
Mean Well GST360A12-C8P 330W power adaptor, Input:85~264V,Output:12V/27.5A,220x95x46mm,L=1000mm,C8P,LV6,62368-1

Installing the M.2 Module

Before installing the M.2 module into the M.2 socket, please make sure that the following safety cautions are well-attended.

1. Make sure the PC and all other peripheral devices connected to it has been powered down.
2. Disconnect all power cords and cables.
3. Locate the M.2 socket on the system board
4. Make sure the notch on card is aligned to the key on the socket.
5. Make sure the standoff screw is removed from the standoff.

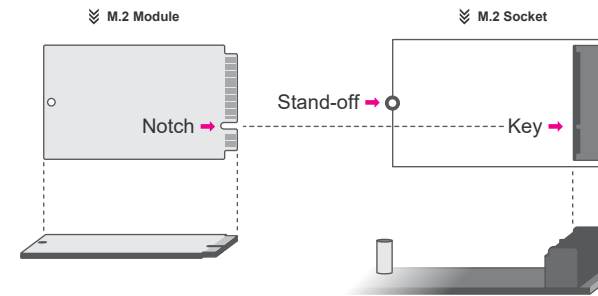
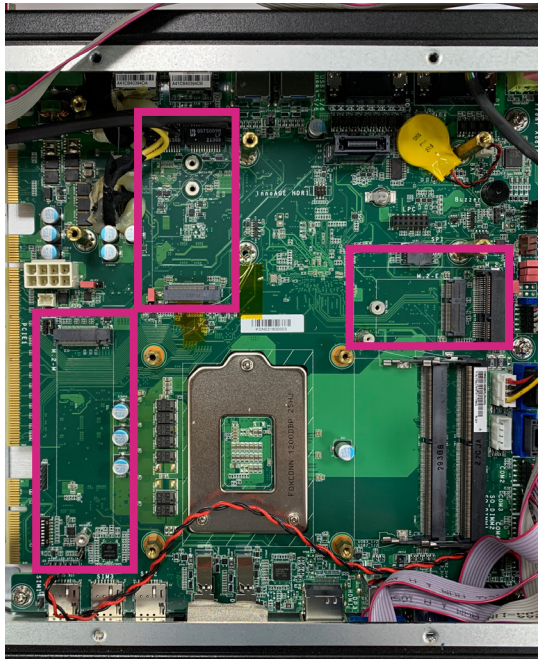

Please follow the steps below to install the card into the socket.

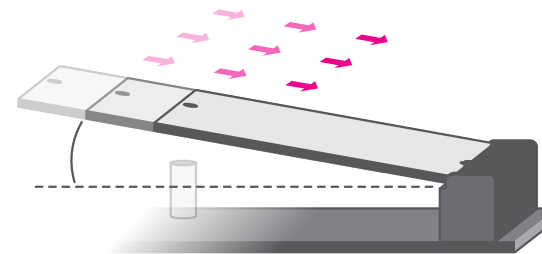

Step 1:
Insert the card into the socket at an angle while making sure the notch and key are perfectly aligned.



Step 2:
Press the end of the card far from the socket down until against the stand-off.

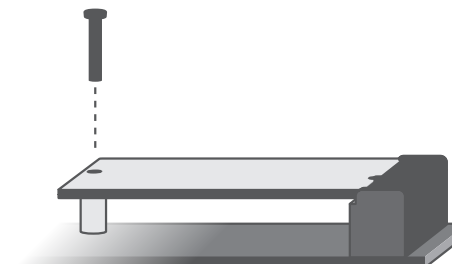

Step 3:
Screw tight the card onto the stand-off with a screw driver and a stand-off screw until the gap between the card and the stand-off closes up. The card should be lying parallel to the board when it's correctly mounted.

Installing the SO-DIMM Module

Before installing the memory module, please make sure that the following safety cautions are well-attended.

1. Make sure the PC and all other peripheral devices connected to it has been powered down.
2. Disconnect all power cords and cables.
3. Locate the SO-DIMM socket on the system board
4. Make sure the notch on memory card is aligned to the key on the socket.

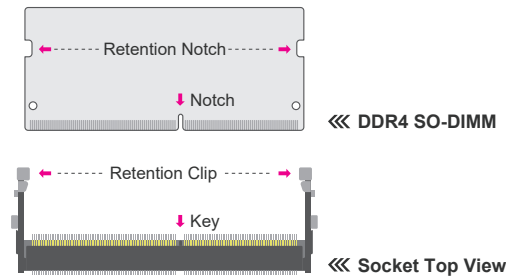
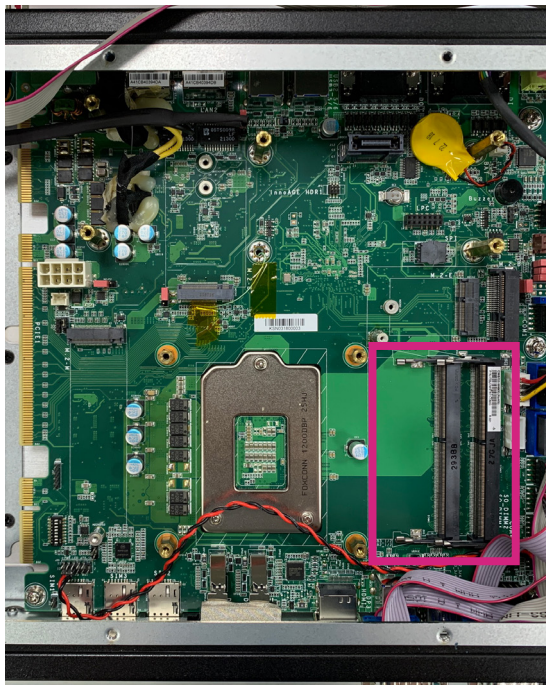

Please follow the steps below to install the memory card into the socket.

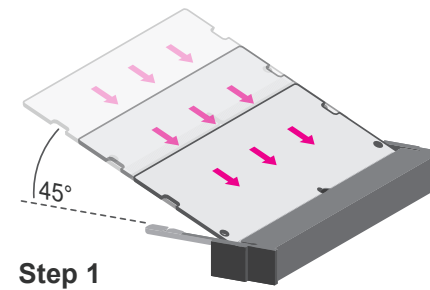

Step 1:
Insert the memory card into the slot while making sure 1) the notch and the key are aligned, and 2) the non-connector end rises approximately 45 degrees horizontally. Press the card firmly into the socket while applying and maintaining even pressure on both ends.

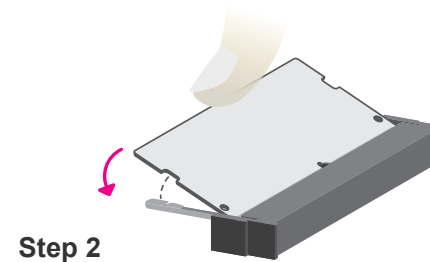

Step 2:
Press the end of the card far from the socket down while making sure the retention notch and the clip align as indicated by the dotted line in the illustration. If the retention notch and the clip do not align, please remove the card and re-insert it. Press the card all the way down.

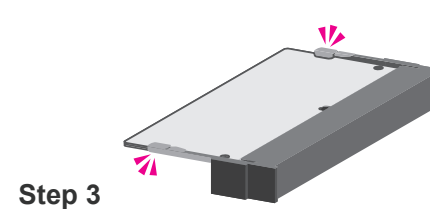

Step 3:
The clips snap automatically and abruptly to the retention notches of the card sounding a distinctive click, and lock the card in place. Inspect that the clip sits in the notch. If not, please pull the clips outward, release and remove the card, and mount it again.

► **Mounting Options**

Wall Mount

The wall mount kit containing two mounting brackets can be attached to the bottom of the system for mounting onto desired locations, such as walls, stands, or shelves. Locate the mounting holes on the bottom of the system as shown in the photo. Screw on the two brackets onto the system with six screws as illustrated below.

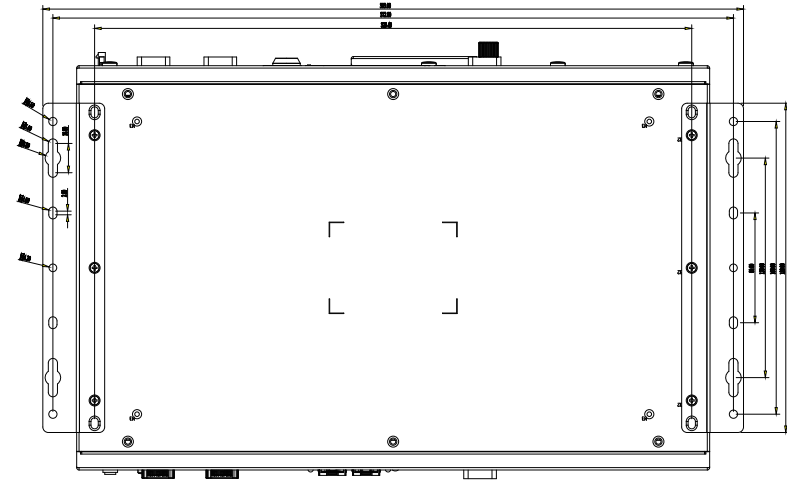
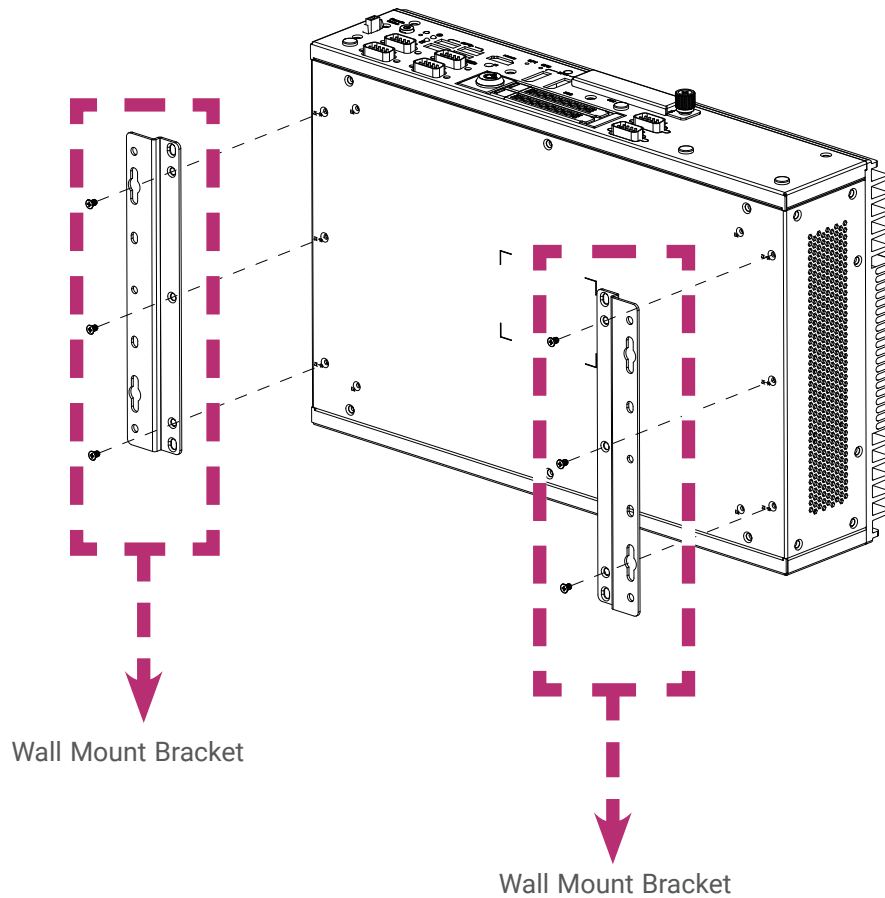

Chapter 3 - System Settings

► Board Layout

Top View

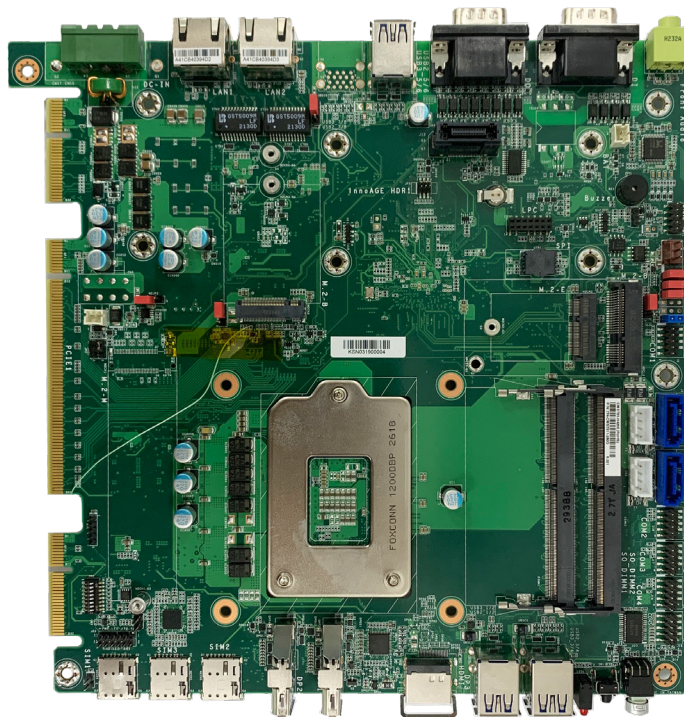

Bottom View

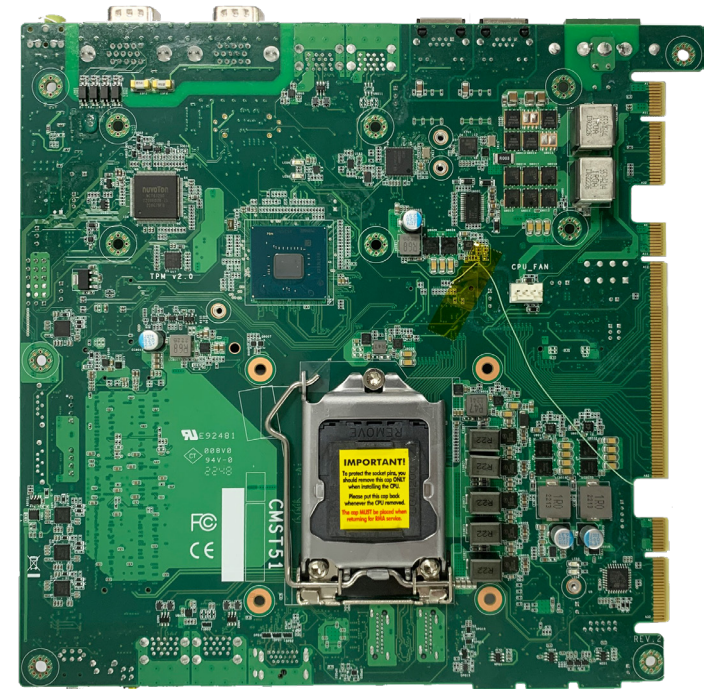

Important:

Electrostatic discharge (ESD) can damage your board, processor, disk drives, add-in boards, and other components. Perform installation procedures at an ESD workstation only. If such a station is not available, you can provide some ESD protection by wearing an antistatic wrist strap and attaching it to a metal part of the system chassis. If a wrist strap is unavailable, establish and maintain contact with the system chassis throughout any procedures requiring ESD protection.

► Jumper Settings

Clear BIOS (JP1)

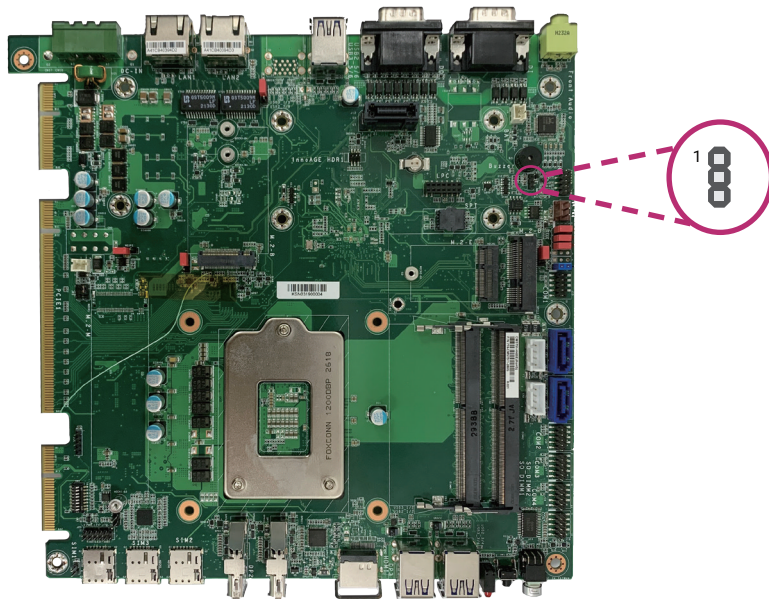

■ 1-2 On: Normal (default)



■ 2-3 On: Clear BIOS

M.2 Key Power (M2JP2)

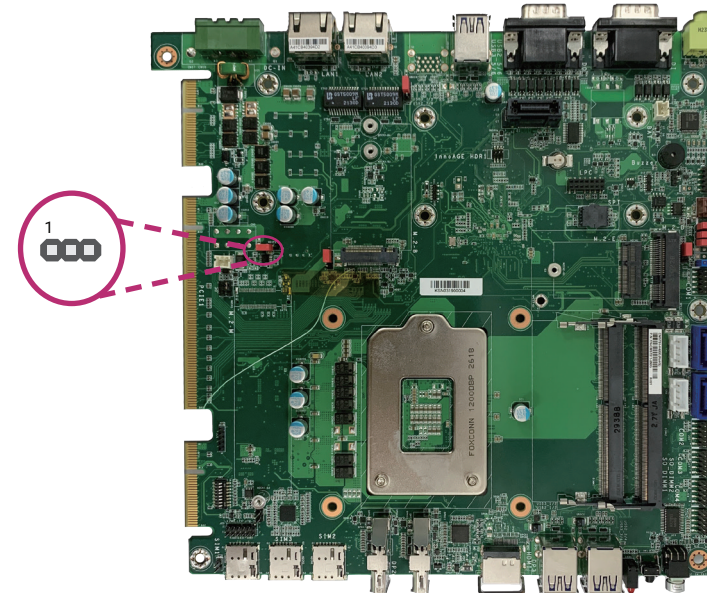

■ 1-2 On: 3V3 (default)



■ 2-3 On: 3V3SB

M.2 Key Power (M2JP1)

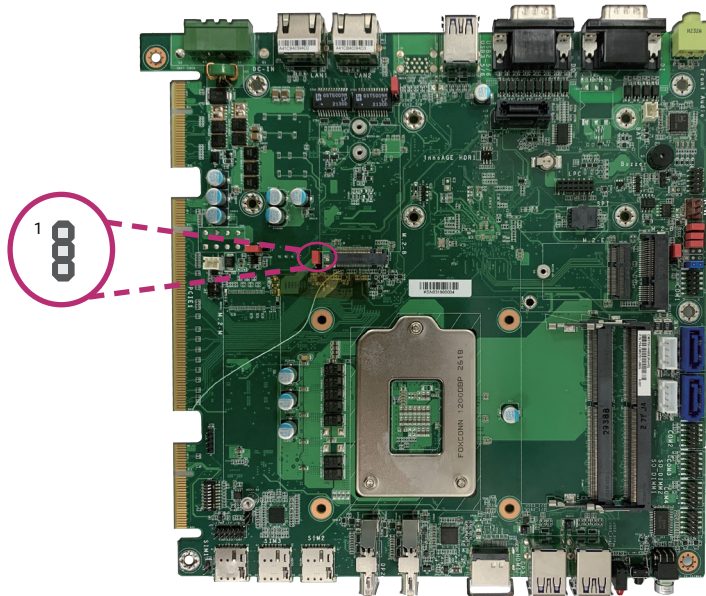

1



■ 1-2 On: 3V3SB



■ 2-3 On: 3V3 (default)

Mini PCIe Power (MPJP1)

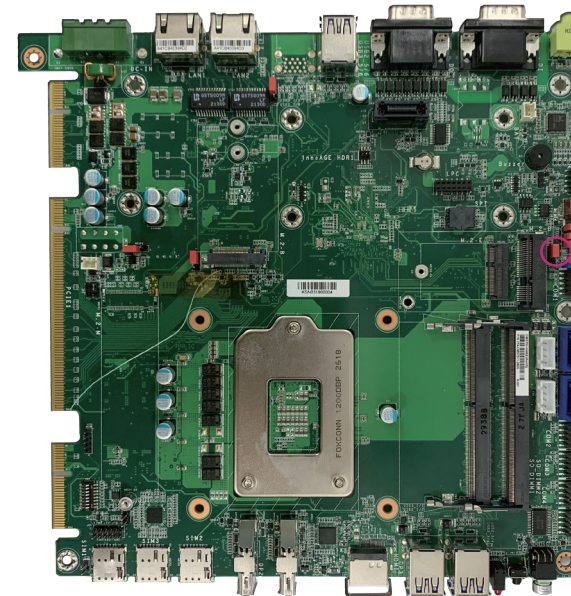

1



■ 1-2 On: 3V3SB



■ 2-3 On: 3V3 (default)

USB Power Control (JP24)

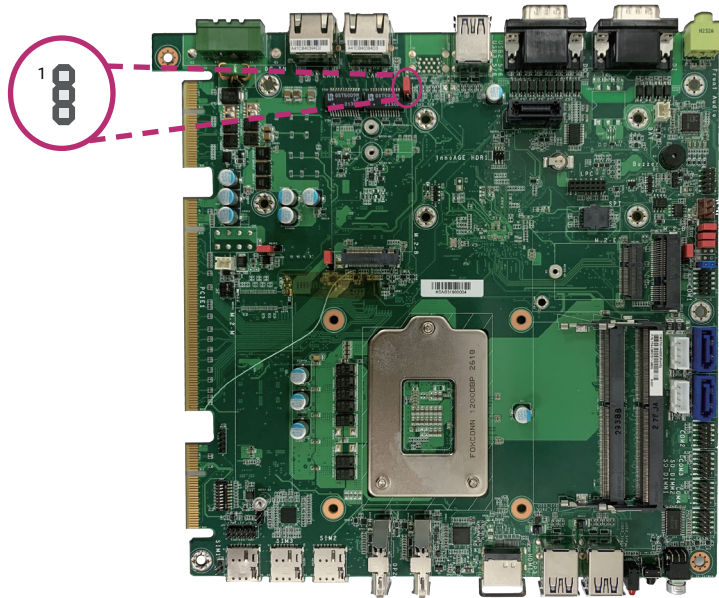

■ 1-2 On: 5VSB



■ 2-3 On: 5V (default)

DIO Power

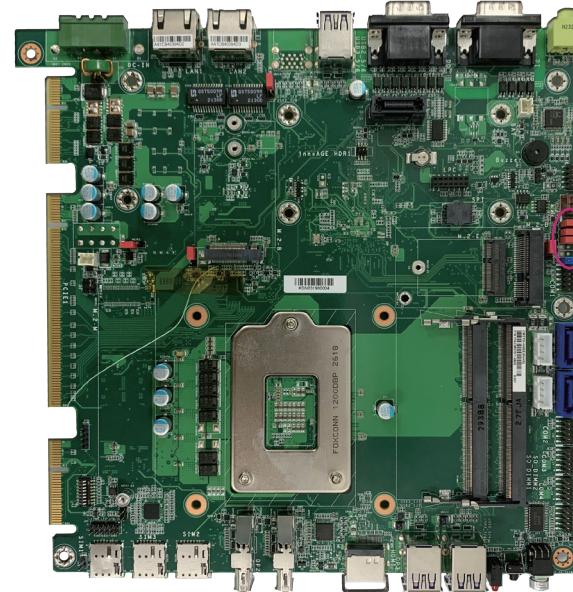

1 DI 0~3 Power (ISJP4)

1 DIO Power with 5V (ISJP5)

1 DO 12~13 Power (ISJP1)

1 DO 8~11 Power (ISJP2)

1 DI 4~7 Power (ISJP3)

ISJP1, ISJP2, ISJP3, ISJP4 :



■ 1-2 On: DIO Power (default)



■ 2-3 On: GND

ISJP5 :



■ 1-2 On: 5VSB (default)



■ 2-3 On: 5V

Power On/ Off Control Table (SW3)

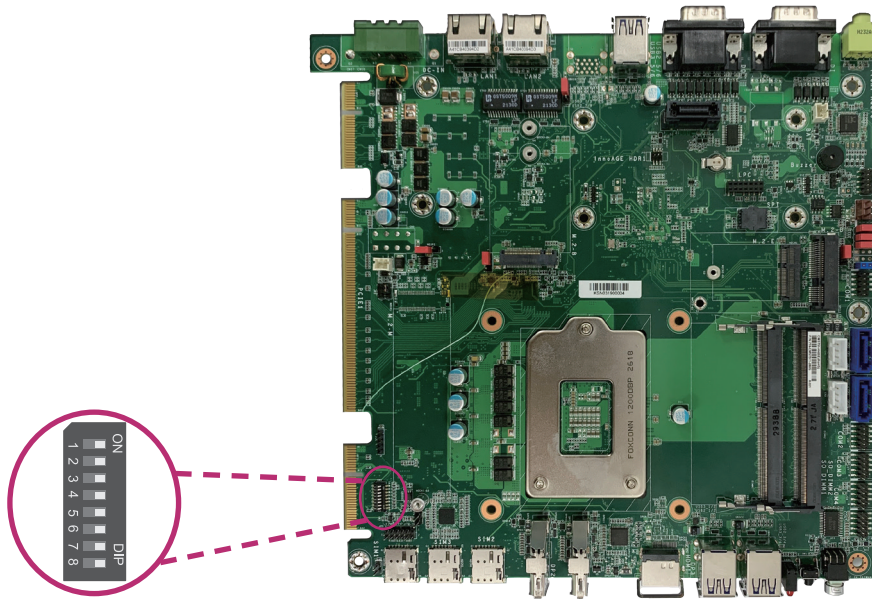

24V/12V Select	
Pin 1 24V_SEL	DC-in Voltage
0 (On)	12V
1	24V

Power On Delay On/Off	
Pin 2 PON_EN	On/Off
0 (On)	Defined by BIOS (default)
1	Defined by jumper

Power Off Delay On/Off	
Pin 3 POFF_EN	On/Off
0 (On)	Defined by BIOS (default)
1	Defined by jumper

Power On Delay Time Select		
Pin4 PON_Delay_S0	Pin5 PON_Delay_S1	Delay Time
0 (On)	0 (On)	10 Sec
1	0	30 Sec
0	1	1 Min
1	1	5 Min

Power Off Delay Time Select			
Pin6 POFF_Delay_S0	Pin7 POFF_Delay_S1	Pin8 POFF_Delay_S2	Delay Time
0 (On)	0 (On)	0 (On)	30 Sec
1	0	0	1 Min
0	1	0	3 Min
1	1	0	5 Min
0	0	1	10 Min
1	0	1	15 Min
0	1	1	30 Min
1	1	1	1 Hr

Chapter 4 - BIOS Settings

► Overview

The BIOS is a program that takes care of the basic level of communication between the CPU and peripherals. It contains codes for various advanced features found in this system board. The BIOS allows you to configure the system and save the configuration in a battery-backed CMOS so that the data retains even when the power is off. In general, the information stored in the CMOS RAM of the EEPROM will stay unchanged unless a configuration change has been made such as a hard drive replaced or a device added.

It is possible that the CMOS battery will fail causing CMOS data loss. If this happens, you need to install a new CMOS battery and reconfigure the BIOS settings.



Note:

The BIOS is constantly updated to improve the performance of the system board; therefore the BIOS screens in this chapter may not appear the same as the actual one. These screens are for reference purpose only.

Default Configuration

Most of the configuration settings are either predefined according to the Load Optimal Defaults settings which are stored in the BIOS or are automatically detected and configured without requiring any actions. There are a few settings that you may need to change depending on your system configuration.

Entering the BIOS Setup Utility

The BIOS Setup Utility can only be operated from the keyboard and all commands are keyboard commands. The commands are available at the right side of each setup screen.

The BIOS Setup Utility does not require an operating system to run. After you power up the system, the BIOS message appears on the screen and the memory count begins. After the memory test, the message "Press DEL to run setup" will appear on the screen. If the message disappears before you respond, restart the system or press the "Reset" button. You may also restart the system by pressing the <Ctrl> <Alt> and keys simultaneously.

Legends

Keys	Function
Right / Left arrow	Move the highlight left or right to select a menu
Up / Down arrow	Move the highlight up or down between submenus or fields
<Enter>	Enter the highlighted submenu
+ (plus key)/F6	Scroll forward through the values or options of the highlighted field
- (minus key)/F5	Scroll backward through the values or options of the highlighted field
<F1>	Display general help
<F2>	Display previous values
<F7>	Popup Boot Device List
<F9>	Optimized defaults
<F10>	Save and Exit
<Esc>	Return to previous menu

Scroll Bar

When a scroll bar appears to the right of the setup screen, it indicates that there are more available fields not shown on the screen. Use the up and down arrow keys to scroll through all the available fields.

Submenu

When "►" appears on the left of a particular field, it indicates that a submenu which contains additional options are available for that field. To display the submenu, move the highlight to that field and press <Enter>.

► Main

The Main menu is the first screen that you will see when you enter the BIOS Setup Utility.

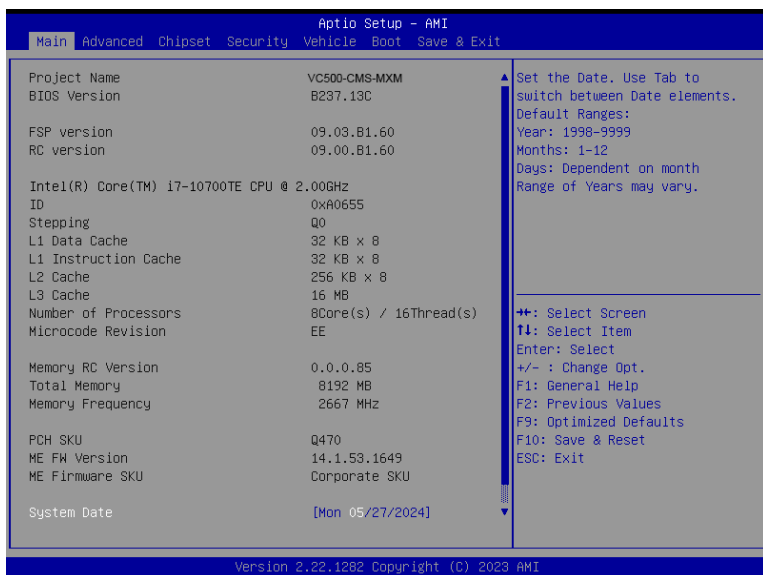

System Date

The date format is <month>, <date>, <year>. Press "Tab" to switch to the next field and press "-" or "+" to modify the value.

System Time

The time format is <hour>, <minute>, <second>. The time is based on the 24-hour military-time clock. For example, 1 p.m. is 13:00:00. Hour displays hours from 00 to 23. Minute displays minutes from 00 to 59. Second displays seconds from 00 to 59.

► Advanced

The Advanced menu allows you to configure your system for basic operation. Some entries are defaults required by the system board, while others, if enabled, will improve the performance of your system or let you set some features according to your preference.



Important:
Setting incorrect field values may cause the system to malfunction.

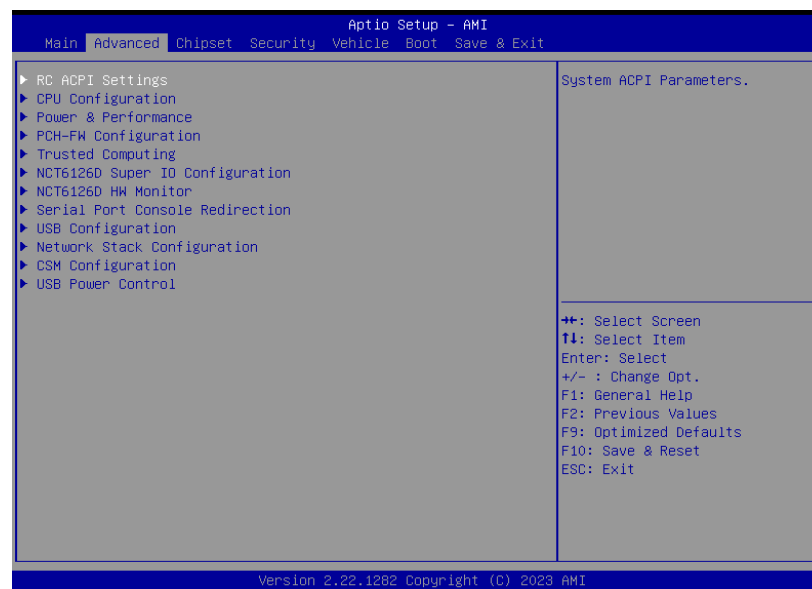

► Advanced

RC ACPI Settings

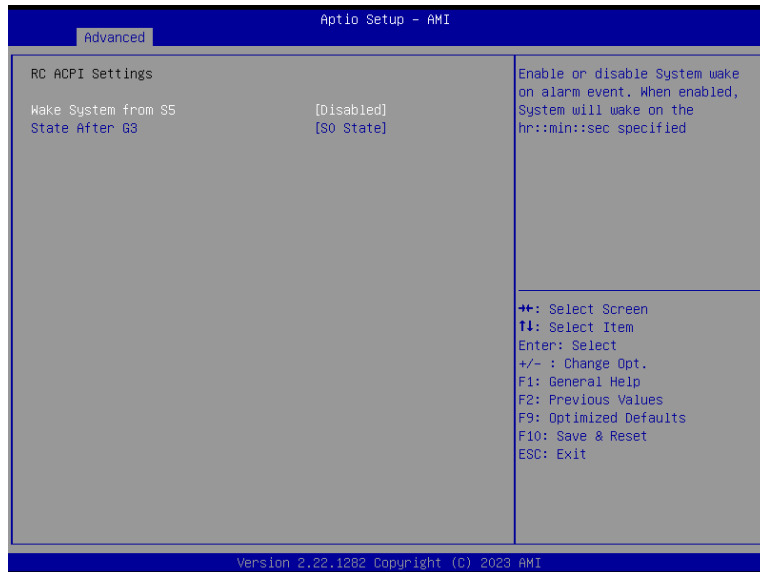

Wake system from S5 via RTC

When Enabled, the system will automatically power up at a designated time every day. Once it's switched to [Enabled], please set up the time of day — hour, minute, and second — for the system to wake up.

State After G3

Select between S0 State, and S5 State. This field is used to specify what state the system is set to return to when power is re-applied after a power failure (G3 state).

- S0 State** The system automatically powers on after power failure.
- S5 State** The system enter soft-off state after power failure. Power-on signal input is required to power up the system.
- Last State** The system returns to the last state right before power failure.

► Advanced

CPU Configuration

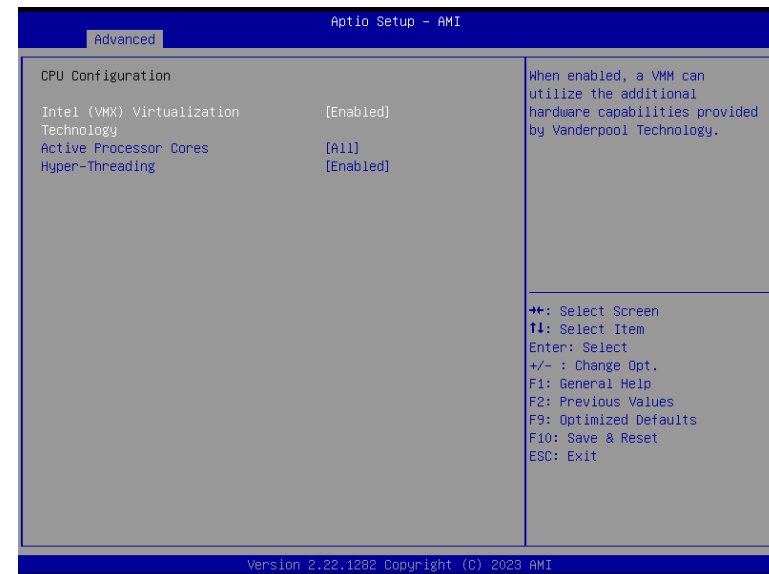

Intel (VMX) Virtualization Technology

When this field is set to Enabled, the VMM can utilize the additional hardware capabilities provided by Vanderpool Technology.

Active Processor Cores

Select number of cores to enable in each processor package: all or 1.

Hyper-threading

Enables this field for Windows XP and Linux which are optimized for Hyper-Threading technology. Select disabled for other OSes not optimized for Hyper-Threading technology. When disabled, only one thread per enabled core is enabled.

▶ Advanced

Power & Performance

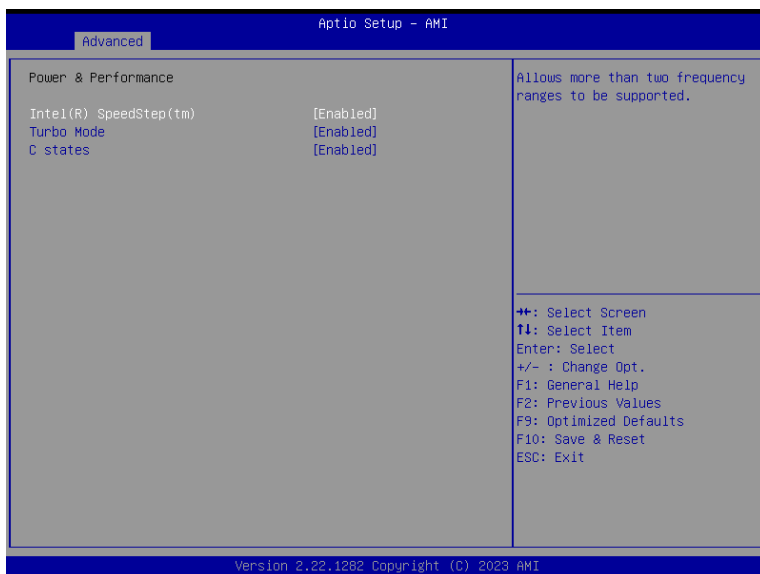

Intel (R) SpeedStep(tm)

This field is used to enable or disable the Intel SpeedStep® Technology, which helps optimize the balance between system's power consumption and performance. After it is enabled in the BIOS, EIST features can then be enabled via the operating system's power management.

Turbo Mode

Enable or disable turbo mode of the processor. This field will only be displayed when EIST is enabled.

C states

Enable or disable CPU Power Management. It allows CPU to enter "C states" when it's idle and nothing is executing.

▶ Advanced

PCH-FW Configuration

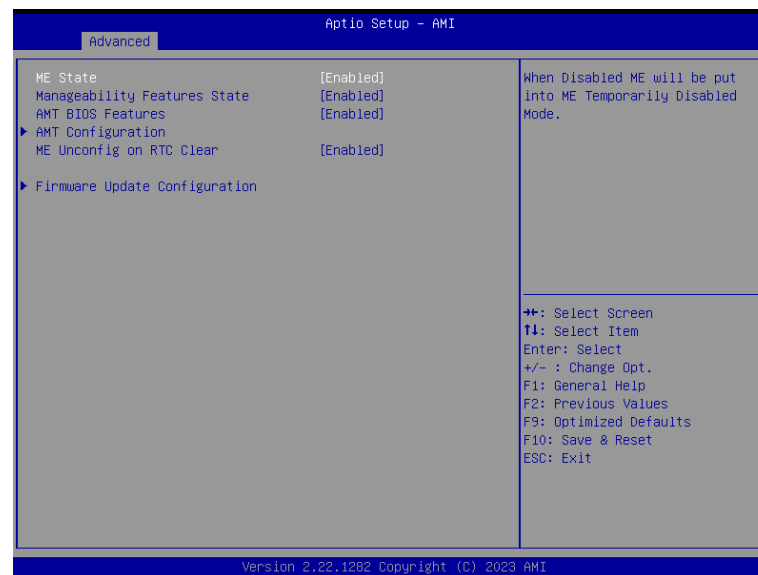

ME State

When this field is set to Disabled, ME will be put into ME Temporarily Disabled Mode.

Manageability Features State

Enable or disable Intel(R) Manageability features. This option disables/enables Manageability Features support in FW. To disable, support platform must be in an unprovisioned state first.

AMT BIOS Features

When disabled, AMT BIOS features are no longer supported and user is no longer able to access MEBx Setup. This option does not disable manageability features in FW.

ME Unconfig on RTC Clear

When disabled, ME will not be unconfigured on RTC Clear.

Firmware Update Configuration

Configure Management Engine Technology Parameters.



Note:
The sub-menus are detailed in following sections.

▶ Advanced

Trusted Computing

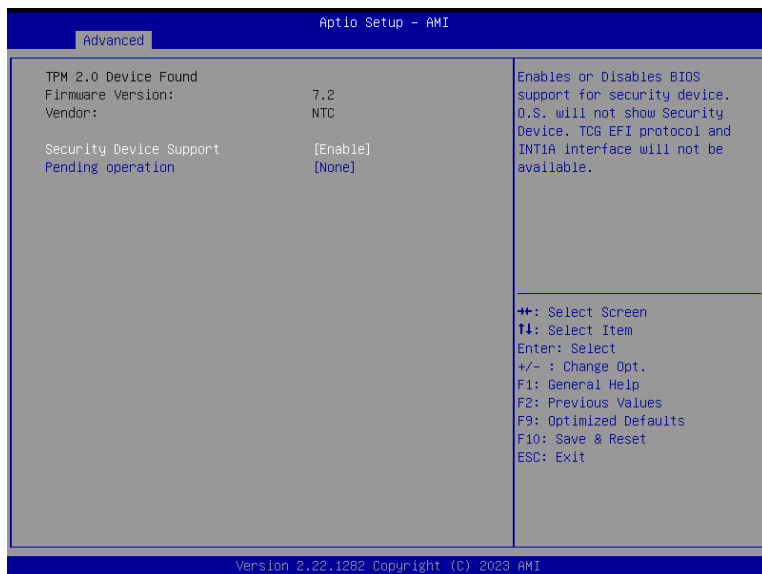

Security Device Support

This field is used to enable or disable BIOS support for the security device such as an TPM 2.0 to achieve hardware-level security via cryptographic keys.

Pending operation

To clear the existing TPM encryption, select "TPM Clear" and restart the system. This field is not available when "Security Device Support" is disabled.

▶ Advanced

NCT6126D Super IO Configuration

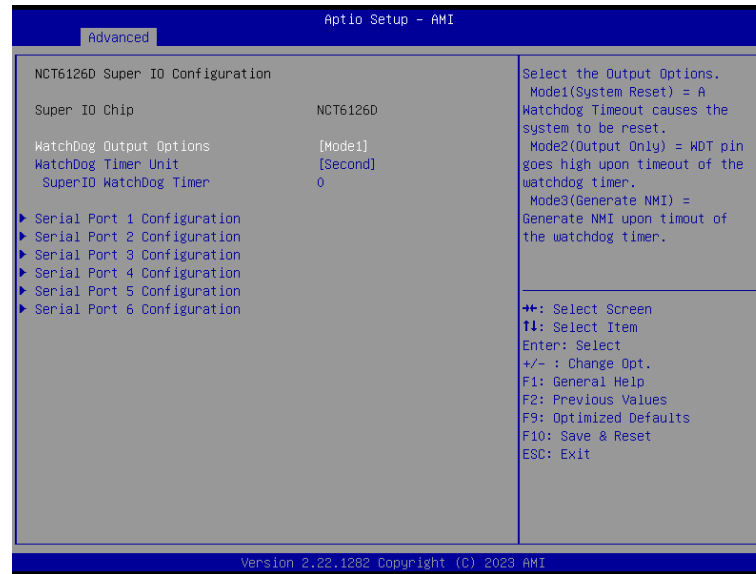

WatchDog Output Options

Select The Output Options.
 Mode1 (System Reset) = A Watchdog Timeout causes the system to be reset.
 Mode2 (Output Only) = WDT pin goes high upon timeout of the watchdog timer.
 Mode3 (Generate NMI) = Generate NMI upon timeout of the watchdog timer.

WatchDog Timer Unit

Select WatchDog Timer Unit – Second or Minute.

SuperIO WatchDog Timer

Set SuperIO WatchDog Timer Timeout value. The range is from 0 (disabled) to 255.



Note:
The sub-menus are detailed in following sections.

► Advanced

NCT6126D Super IO Configuration ► Serial Port 1,2 Configuration

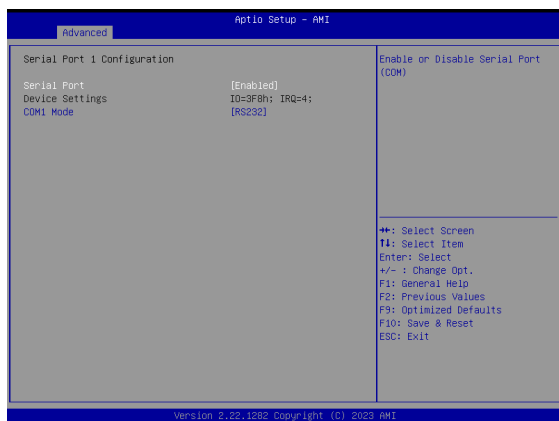

Serial Port

Enable or disable serial port.

Electrical Interface Mode

Choose mode between RS232 / RS485 / RS422

► Advanced

NCT6126D Super IO Configuration ► Serial Port 3,4 Configuration



Serial Port

Enable or disable serial port.

Electrical Interface Mode

Choose mode between RS232 / RS485 / RS422

▶ Advanced

NCT6126D Super IO Configuration ▶ Serial Port 5,6 Configuration

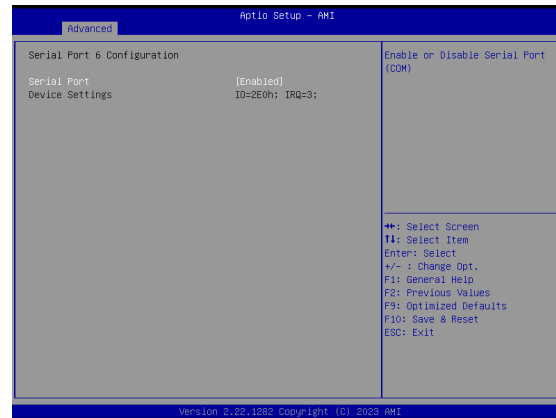
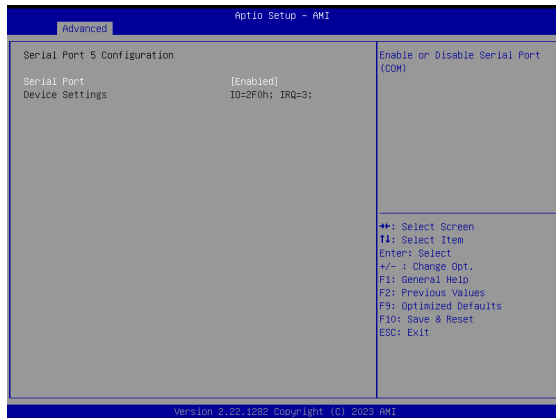

Serial Port

Enable or disable serial port.

▶ Advanced

NCT6126D HW Monitor

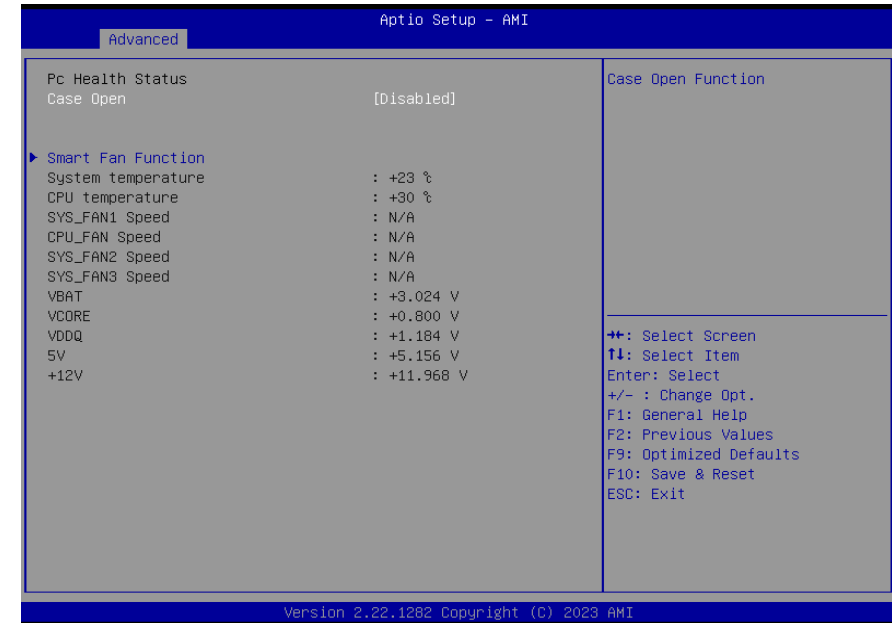

This section displays the system's health information, i.e. voltage readings, CPU and system temperatures, and fan speed readings

► Advanced

NCT6126D HW Monitor ► Smart FAN Function

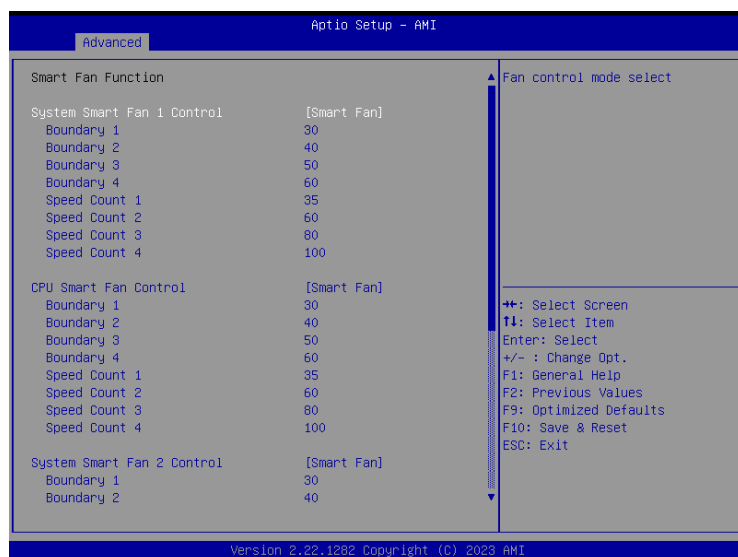

Smart Fan is a fan speed moderation strategy dependent on the current system temperature. When the system temperature goes higher than the Boundary setting, the fan speed will be turned up to the setting of the Fan Speed Count that bears the same index as the Boundary field.

SYS Smart Fan/CPU Smart Fan Control = [Enabled]

• **Boundary 1 to Boundary 4**

Set the boundary temperatures that determine the fan speeds accordingly, the value ranging from 0-127°C. For example, when the system temperature reaches Boundary 1 setting, the fan speed will be turned up to the designated speed of the Fan Speed Opt. 1 field.

• **Fan Speed Count 1 to Fan Speed Count 4**

Set the fan speed, the value ranging from 1-100%, 100% being full speed. The fans will operate according to the specified boundary temperatures above-mentioned.

SYS Smart Fan/CPU Smart Fan Control = [Disabled]

• **Fix Fan Speed Count**

Set the fan speed, the value ranging from 1-100%, 100% being full speed. The fans will always operate at the specified speed regardless of gauged temperatures.

► Advanced

Serial Port Console Redirection

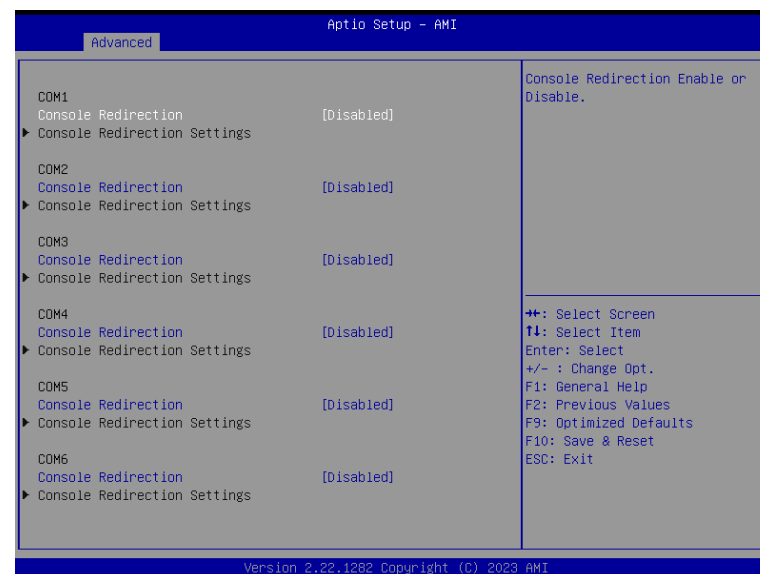

Console Redirection

Console Redirection Enable or Disable.

Console Redirection Settings

See following pages.

► Advanced

Serial Port Console Redirection ► Console Redirection Settings



Serial Port Console Redirection ► Console Redirection Settings



Serial Port Console Redirection ► Console Redirection Settings

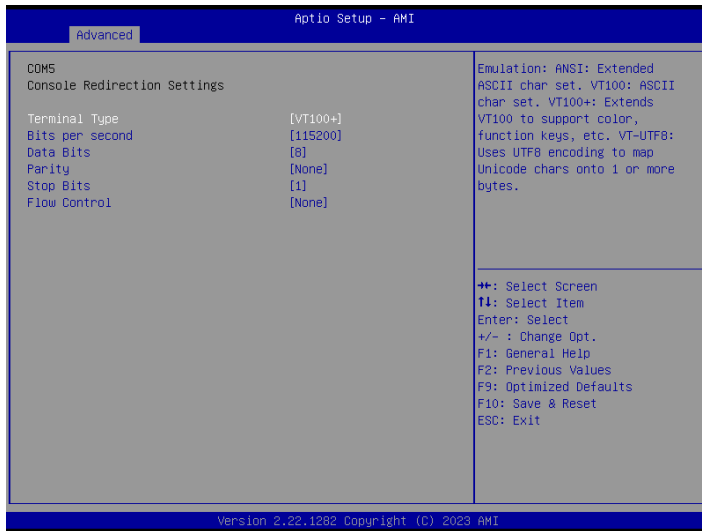

Configure the serial settings of the current COM port.

Terminal Type

Select terminal type: VT100, VT100+, VT-UTF8 or ANSI.

Bits per second

Select serial port transmission speed: 9600, 19200, 38400, 57600 or 115200.

Data Bits

Select data bits: 7 bits or 8 bits.

Parity

Select parity bits: None, Even, Odd, Mark or Space.

Stop Bits

Select stop bits: 1 bit or 2 bits.

Flow Control

Select flow control type: None or RTS/CTS.



► Advanced

USB Configuration

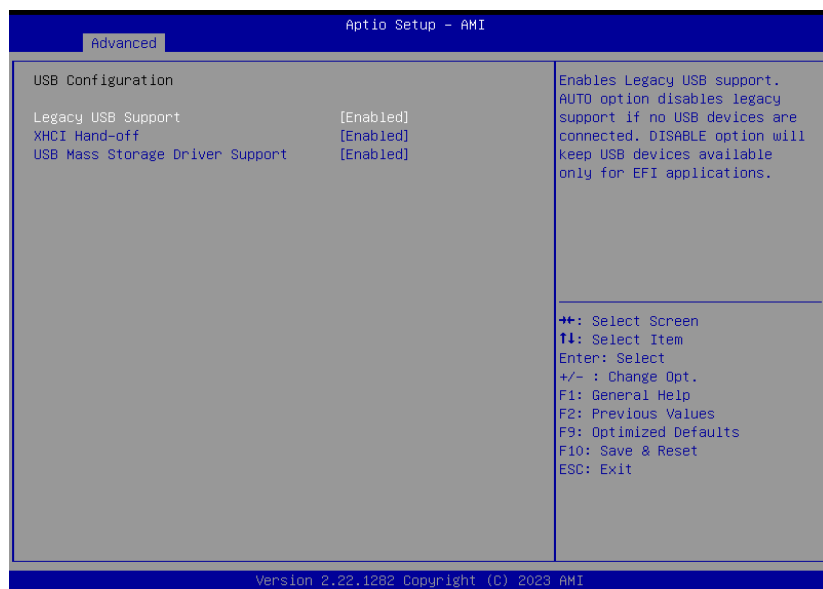

Legacy USB Support

- Enabled** Enable Legacy USB support.
- Disabled** Keep USB devices available only for EFI applications.
- Auto** Disable Legacy support if no USB devices are connected.

XHCI Hand-off

Enable or disable XHCI Hand-off.

USB Mass Storage Driver Support

Enable or disable USB Mass Storage Driver Support.

► Advanced

Network Stack Configuration

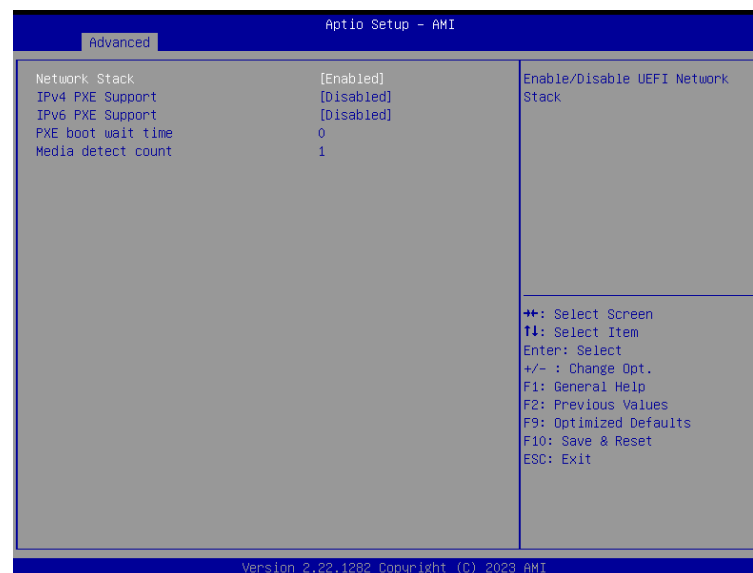

Network Stack

Enable or disable (Default) UEFI network stack. The following fields will appear when this field is enabled.

IPv4 PXE Support Enable or disable IPv4 PXE boot support. If disabled, IPv4 PXE boot support will not be available.

IPv6 PXE Support

Enable or disable IPv6 PXE boot support. If disabled, IPv6 PXE boot support will not be available.

PXE boot wait time

Set the wait time in seconds to press ESC key to abort the PXE boot. Use either +/- or numeric keys to set the value.

Media detect count

Set the number of times the presence of media will be checked. Use either +/- or numeric keys to set the value.

▶ Advanced

CSM Configuration

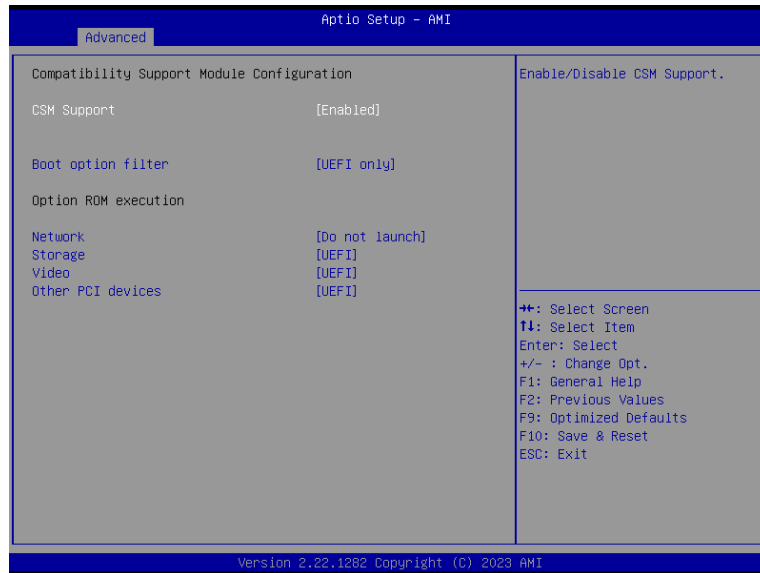

CSM (Compatibility Support Module) Support

Enable or disable CSM Support.

Boot option filter

This option controls Legacy/UEFI ROMs priority.

Network

Controls the execution of UEFI and Legacy Network OpROM

Storage

Controls the execution of UEFI and Legacy Storage OpROM

Video

Controls the execution of UEFI and Legacy Video OpROM

Other PCI devices

Determines OpROM execution policy for devices otherthan Network, Storage, or Video.

▶ Advanced

USB Power Control

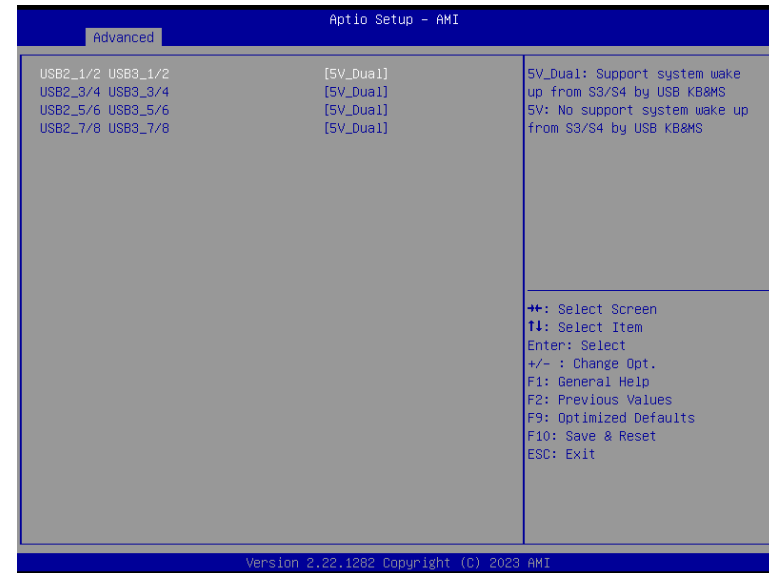

USB Power

5V_Dual: Support system wake from S3/S4 by USB KB&MS

5V: No Support system wake from S3/S4 by USB KB&MS

► Chipset



► Chipset

Graphics Configuration

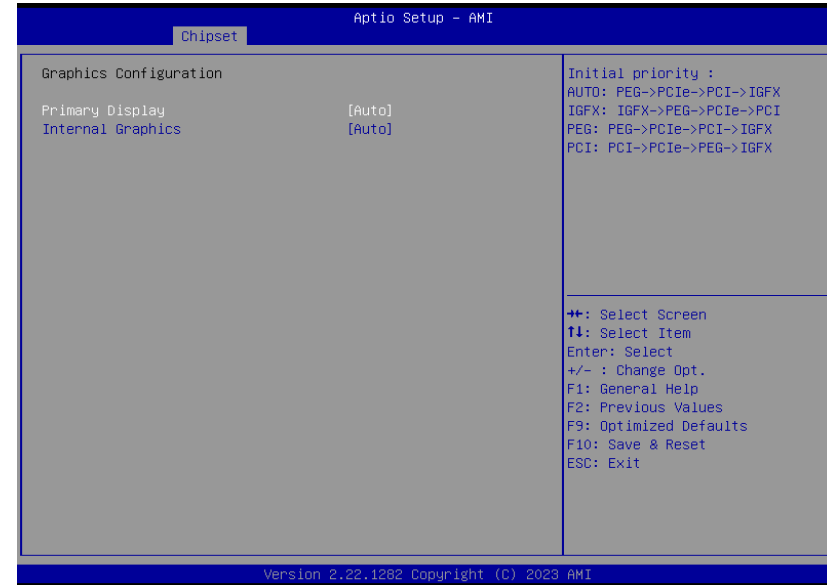

Primary Display

Select which of IGFX/PEG/PCI Graphics device to be the primary display.

Internal Graphics

Keep IGFX "Enabled" or "Disabled" based on the setup options, or select "Auto" for auto-detection.

► Chipset

PEG Port Configuration

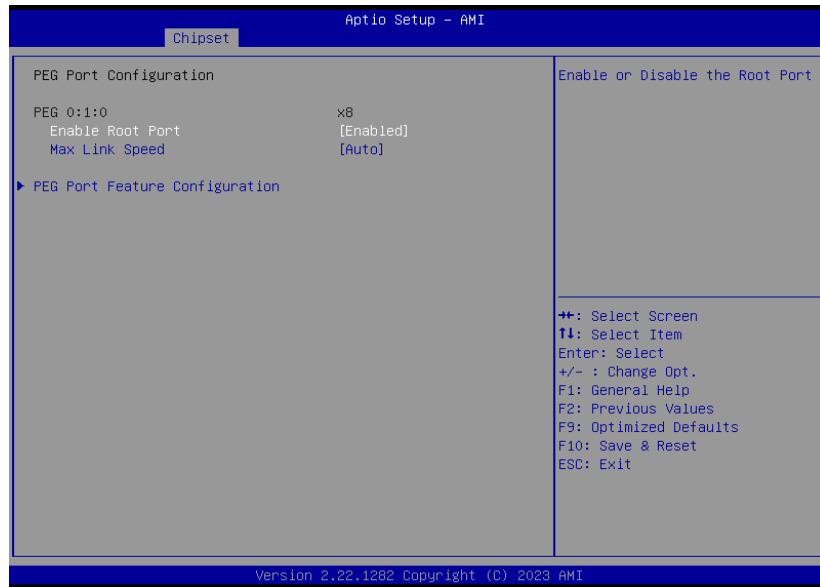

Enable Root Port

Enable/Disable the Root Port

Max Link Speed

Configure PEG 0:1:0 Max Speed

► Chipset

PEG Port Configuration ► PEG Port Feature Configuration

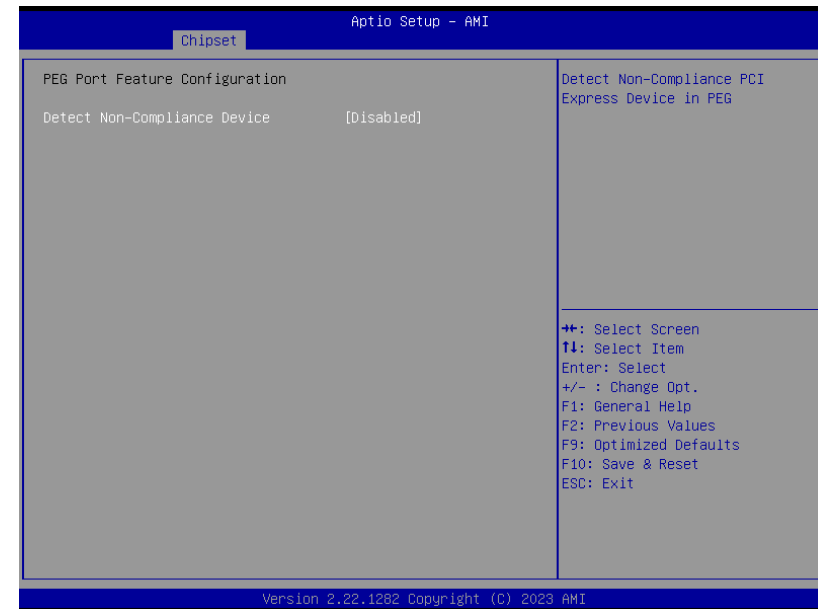

Detect Non-Compliance Device

Detect Non-Compliance PCI Express Device in PEG

► Chipset

PCH-IO Configuration

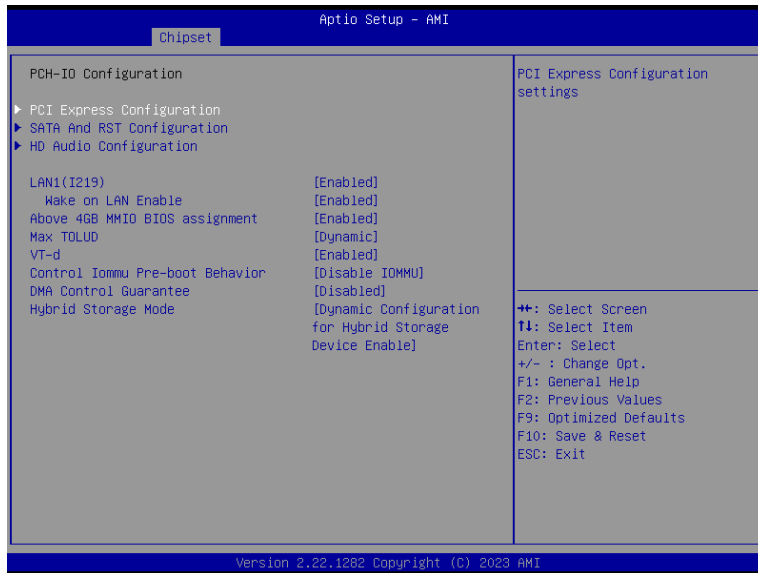

PCI Express Configuration

PCI Express Configuration Settings

SATA And RST Configuration

SATA Device Options Settings

HD Audio Configuration

HD Audio Subsystem Configuration Settings

LAN1(I219)

Enable or disable onboard NIC.

Wake on LAN Enable

Enable or disable integrated LAN to wake the system.

Above 4GB MMIO BIOS assignment

Enable/Disable above 4GB MemoryMappedIO BIOS assignment. This is enabled automatically when Aperture Size is set to 2048MB.

Max TOLUD

Assign the maximum value of Top Of Lower Usable DRAM (TOLUD). Select to specify a fixed value, or select "Dynamic" so that the assignment would adjust TOLUD automatically based on largest MMIO length of installed graphic controller.

VT-d

VT-d capability

Control Iommu Pre-boot Behavior

Enable dTBT and PCH USB topology IOMMU in Pre-boot environment (If DMAR table is installed in DXE and If VTD_INFO_PPI is installed in PEI.) TBT tree won't be included in the exception list.

DMA Control Guarantee

Enable/Disable DMA_CONTROL_GUARANTEE bit.

Hybrid Storage Mode

Select Hybrid Storage detection and configuration Mode.

► Chipset

PCH-IO Configuration ► PCI Express Configuration



Select one of the PCI Express channels and press enter to configure the following settings.

LAN 2 & Mini PCIE, M.2-E, M.2-M, M.2-B

Control the PCI Express Root Port.

► Chipset

PCH-IO Configuration ► SATA And RST Configuration



SATA Controller(s)

This field is used to enable or disable the Serial ATA controller.

SATA Speed

This field is used to select SATA speed generation limit: Auto, Gen1, Gen2 or Gen3.

SATA Mode Selection

The mode selection determines how the SATA controller(s) operates.

- **AHCI** This option allows the Serial ATA controller(s) to use AHCI (Advanced Host Controller Interface).
- **Intel RST Premium With Intel Optane System Acceleration** This option allows you to create RAID or Intel Rapid Storage configuration along with Intel® Optane™ system acceleration on Serial ATA devices.

Ports and Hot Plug

Enable or disable the Serial ATA port and its hot plug function.

► **Chipset**

PCH-IO Configuration ► **HD Audio Configuration**



HD Audio

Control the detection of the HD Audio device.

Disabled HDA will be unconditionally disabled.

Enabled HDA will be unconditionally enabled.

► Security

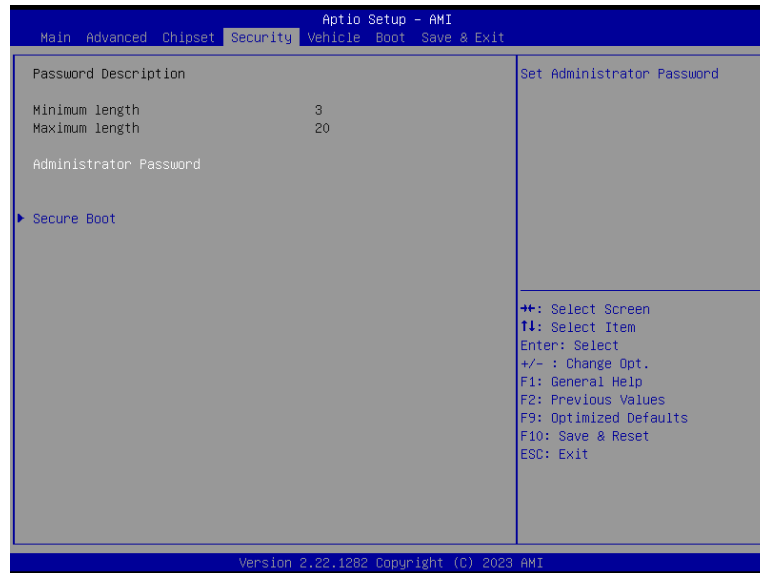

Administrator Password

Set the administrator password. To clear the password, input nothing and press enter when a new password is asked. Administrator Password will be required when entering the BIOS.

► Security

Secure Boot



Secure Boot

Secure Boot feature is Active if secure Boot is Enabled, Platform Key (PK) is enrolled and the system is in user mode. The mode change requires platform reset.

Secure Boot Mode

Select the secure boot mode – Standard or Custom. When set to Custom, the following fields will be configurable for the user to manually modify the key database.

Restore Factory Keys

Force system to User Mode. Load OEM-defined factory defaults of keys and databases onto the Secure Boot. Press Enter and a prompt will show up for you to confirm.

Reset To Setup Mode

Clear the database from the NVRAM, including all the keys and signatures installed in the Key Management menu. Press Enter and a prompt will show up for you to confirm.

► Vehicle

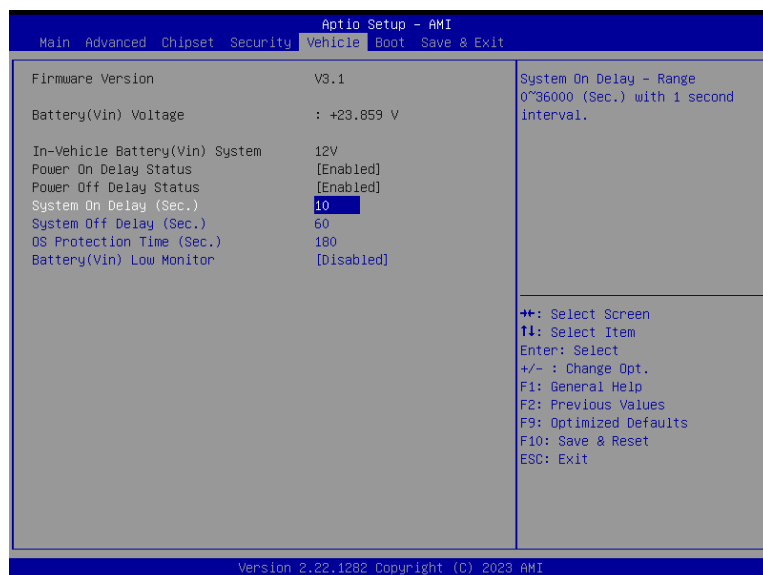

Power On Delay Status

Power on delay status

Power Off Delay Status

Power off delay status

System On Delay (Sec.)

System On Delay - Range 0 ~36000 (Sec.) with 1 second interval.

System Off Delay (Sec.)

System Off Delay - Range 0 ~36000 (Sec.) with 1 second interval.

OS Protection Time (Sec.)

OS Protection Time- Range:
Range 120~36000 (Sec.) with 10 second intervals.

Battery(Vin) Low Monitor

Battery(Vin) Low Monitor

► Boot



Setup Prompt Timeout

Set the number of seconds to wait for the setup activation key. 65535 (0xFFFF) denotes indefinite waiting.

Bootup NumLock State

Select the keyboard NumLock state: On or Off.

Quiet Boot

This section is used to enable or disable quiet boot option.

Boot Option Priorities

Rearrange the system boot order of available boot devices.

► Save & Exit



Save Changes and Reset

To save the changes, select this field and then press <Enter>. A dialog box will appear. Select Yes to reset the system after saving all changes made.

Discard Changes and Reset

To discard the changes, select this field and then press <Enter>. A dialog box will appear. Select Yes to reset the system setup without saving any changes.

Restore Defaults

To restore and load the optimized default values, select this field and then press <Enter>. A dialog box will appear. Select Yes to restore the default values of all the setup options.

Boot Override

Move the cursor to an available boot device and press Enter, and then the system will immediately boot from the selected boot device. The Boot Override function will only be effective for the current boot. The "Boot Option Priorities" configured in the Boot menu will not be changed.

► **Save Setting to file**

Select this option to save BIOS configuration settings to a USB flash device.

► **Restore Setting from file**

This field will appear only when a USB flash device is detected. Select this field to restore setting from the USB flash device.

► Updating the BIOS

To update the BIOS, you will need the new BIOS file and a flash utility. Please contact technical support or your sales representative for the files and specific instructions about how to update BIOS with the flash utility.

► Notice: BIOS SPI ROM

1. The Intel® Management Engine has already been integrated into this system board. Due to the safety concerns, the BIOS (SPI ROM) chip cannot be removed from this system board and used on another system board of the same model.
2. The BIOS (SPI ROM) on this system board must be the original equipment from the factory and cannot be used to replace one which has been utilized on other system boards.
3. If you do not follow the methods above, the Intel® Management Engine will not be updated and will cease to be effective.



Note:

- a. You can take advantage of flash tools to update the default configuration of the BIOS (SPI ROM) to the latest version anytime.
- b. When the BIOS IC needs to be replaced, you have to populate it properly onto the system board after the EEPROM programmer has been burned and follow the technical person's instructions to confirm that the MAC address should be burned or not.
- c. After updating unique MAC Address from manufacturing, NVM will be protected immediately after power cycle. Users cannot update NVM or MAC address.