



# **EC500-SD**

## **User's Manual**

## Copyright

This publication contains information that is protected by copyright. No part of it may be reproduced in any form or by any means or used to make any transformation/adaptation without the prior written permission from the copyright holders.

This publication is provided for informational purposes only. The manufacturer makes no representations or warranties with respect to the contents or use of this manual and specifically disclaims any express or implied warranties of merchantability or fitness for any particular purpose. The user will assume the entire risk of the use or the results of the use of this document. Further, the manufacturer reserves the right to revise this publication and make changes to its contents at any time, without obligation to notify any person or entity of such revisions or changes.

Changes after the publication's first release will be based on the product's revision. The website will always provide the most updated information.

© 2017. All Rights Reserved.

## Trademarks

Product names or trademarks appearing in this manual are for identification purpose only and are the properties of the respective owners.

## FCC and DOC Statement on Class A

This equipment has been tested and found to comply with the limits for a Class A digital device, pursuant to Part 15 of the FCC rules. These limits are designed to provide reasonable protection against harmful interference when the equipment is operated in a residential installation. This equipment generates, uses and can radiate radio frequency energy and, if not installed and used in accordance with the instruction manual, may cause harmful interference to radio communications. However, there is no guarantee that interference will not occur in a particular installation. If this equipment does cause harmful interference to radio or television reception, which can be determined by turning the equipment off and on, the user is encouraged to try to correct the interference by one or more of the following measures:

- Reorient or relocate the receiving antenna.
- Increase the separation between the equipment and the receiver.
- Connect the equipment into an outlet on a circuit different from that to which the receiver is connected.
- Consult the dealer or an experienced radio TV technician for help.

### Notice:

1. The changes or modifications not expressly approved by the party responsible for compliance could void the user's authority to operate the equipment.
2. Shielded interface cables must be used in order to comply with the emission limits.

## Table of Contents

Copyright.....	2
Trademarks.....	2
FCC and DOC Statement on Class A.....	2
About this Manual.....	4
Warranty .....	4
Static Electricity Precautions.....	4
Safety Measures.....	4
Safety Precautions.....	5
About the Package.....	5
Chapter 1 - Introduction.....	6
Overview.....	6
Key Features.....	6
Specifications.....	7
Getting to Know the EC500-SD .....	8
Mechanical Dimensions.....	9
Chapter 2 - Getting Started.....	10
Chapter 3 - Installing the Devices.....	11
Removing the Chassis Cover.....	11
Installing a SODIMM.....	12
Installing a 2.5" SATA Drive.....	13
Installing a CFast Card.....	14
Installing a Mini PCIe or mSATA Card.....	14
Installing a CPU.....	16
Chapter 4 - Jumper Settings.....	18
Clear CMOS Data.....	18
Auto Power-on Select.....	18
COM1/COM2 RS232 Power Select.....	19

COM1/COM2 RS232/422/485 Select.....	20
COM3/COM4 RS232/422/485 Select.....	21
Chapter 5 - Ports and Connectors.....	22
Front Panel I/O Ports.....	22
USB Ports.....	22
COM (Serial) Ports .....	23
Rear Panel I/O Ports.....	23
RJ45 LAN Ports.....	24
Display Interfaces.....	24
USB Ports.....	25
9~36V DC-in.....	25
Rear Audio Connector.....	26
I/O Connectors.....	26
Parallel Connector.....	26
Front Panel Connector.....	27
SATA (Serial ATA) Connectors.....	27
SATA (Serial ATA) Power Connectors.....	28
SMBus Connector.....	28
Cooling Fan Connectors.....	29
Digital I/O Connector.....	29
S/PDIF Connector.....	30
LPC Connector.....	30
Expansion Slots.....	31
12V DC-out.....	32
Chapter 6 - Mounting Options.....	33
Chapter 7 - BIOS Setup.....	34
Main.....	35
Advanced.....	35
Security.....	43
Boot.....	44
Exit.....	46
Chapter 8 - Supported Software.....	48
Chapter 9 - RAID .....	64
Chapter 10 - Intel AMT Settings .....	68

## About this Manual

An electronic file of this manual can be obtained from the DFI website at [www.dfi.com](http://www.dfi.com). To download the user's manual from our website, please go to "Support" > "Download Center." On the Download Center page, select your product or type the model name and click "Search" to find all technical documents including the user's manual for a specific product.

## Warranty

1. Warranty does not cover damages or failures that arised from misuse of the product, inability to use the product, unauthorized replacement or alteration of components and product specifications.
2. The warranty is void if the product has been subjected to physical abuse, improper installation, modification, accidents or unauthorized repair of the product.
3. Unless otherwise instructed in this user's manual, the user may not, under any circumstances, attempt to perform service, adjustments or repairs on the product, whether in or out of warranty. It must be returned to the purchase point, factory or authorized service agency for all such work.
4. We will not be liable for any indirect, special, incidental or damages to the product that has been modified or altered.

## Static Electricity Precautions

It is quite easy to inadvertently damage your PC, system board, components or devices even before installing them in your system unit. Static electrical discharge can damage computer components without causing any signs of physical damage. You must take extra care in handling them to ensure against electrostatic build-up.

1. To prevent electrostatic build-up, leave the system board in its anti-static bag until you are ready to install it.
2. Wear an antistatic wrist strap.
3. Do all preparation work on a static-free surface.
4. Hold the device only by its edges. Be careful not to touch any of the components, contacts or connections.
5. Avoid touching the pins or contacts on all modules and connectors. Hold modules or connectors by their ends.



### Important:

Electrostatic discharge (ESD) can damage your processor, disk drive and other components. Perform the upgrade instruction procedures described at an ESD workstation only. If such a station is not available, you can provide some ESD protection by wearing an antistatic wrist strap and attaching it to a metal part of the system chassis. If a wrist strap is unavailable, establish and maintain contact with the system chassis throughout any procedures requiring ESD protection.

## Safety Measures

To avoid damage to the system:

- Use the correct AC input voltage range.

To reduce the risk of electric shock:

- Unplug the power cord before removing the system chassis cover for installation or servicing. After installation or servicing, cover the system chassis before plugging the power cord.

Battery:

- Danger of explosion if battery incorrectly replaced.
- Replace only with the same or equivalent type recommend by the manufacturer.
- Dispose of used batteries according to local ordinance.

## Safety Precautions

- Use the correct DC input voltage range.
- Unplug the power cord before removing the system chassis cover for installation or servicing. After installation or servicing, cover the system chassis before plugging the power cord.
- Danger of explosion if battery incorrectly replaced.
- Replace only with the same or equivalent type recommend by the manufacturer.
- Dispose of used batteries according to local ordinance.
- Keep this system away from humidity.
- Place the system on a stable surface. Dropping it or letting it fall may cause damage.
- The openings on the system are for air ventilation to protect the system from overheating. **DO NOT COVER THE OPENINGS.**
- Place the power cord in such a way that it will not be stepped on. Do not place anything on top of the power cord. Use a power cord that has been approved for use with the system and that it matches the voltage and current marked on the system's electrical range label.
- If the system will not be used for a long time, disconnect it from the power source to avoid damage by transient overvoltage.
- If one of the following occurs, consult a service personnel:
  - The power cord or plug is damaged.
  - Liquid has penetrated the system.
  - The system has been exposed to moisture.
  - The system is not working properly.
  - The system dropped or is damaged.
  - The system has obvious signs of breakage.
- The unit uses a three-wire ground cable which is equipped with a third pin to ground the unit and prevent electric shock. Do not defeat the purpose of this pin. If your outlet does not support this kind of plug, contact your electrician to replace the outlet.
- Disconnect the system from the DC outlet before cleaning. Use a damp cloth. Do not use liquid or spray detergents for cleaning.

## About the Package

The package contains the following items. If any of these items are missing or damaged, please contact your dealer or sales representative for assistance.

- 1 EC500-SD system unit

## Optional Items

- Wall Mount kit
- Power Cord
- Power Adapter (100W/120W)

The board and accessories in the package may not come similar to the information listed above. This may differ in accordance to the sales region or models in which it was sold. For more information about the standard package in your region, please contact your dealer or sales representative.

## Chapter 1 - Introduction

### Overview



Front View



Rear View

### Key Features

<b>Model Name</b>	<b>EC500-SD</b>
<b>Processor</b>	6th Generation Intel® Core™ processors
<b>Chipset</b>	Intel® Q170 Chipset
<b>LAN</b>	2 LAN ports
<b>COM</b>	4 COM ports
<b>Audio</b>	Line-out and microphone jack
<b>Display</b>	VGA DVI (DVI-D signal) HDMI or DP (DP available upon request)
<b>USB</b>	2 USB 2.0 Type A ports, 4 USB 3.0 Type A ports
<b>Power</b>	9~36V DC-in

## Specifications

<b>Processor System</b>	6th Generation Intel® Core™ Processors, LGA 1151 Socket Intel® Core™ i7-6700TE, Quad Core, 8M Cache, 2.4GHz (3.4GHz), 35W Intel® Core™ i5-6500TE, Quad Core, 6M Cache, 2.3GHz (3.3GHz), 35W Intel® Core™ i3-6100TE, Dual Core, 4M Cache, 2.7GHz, 35W
<b>Chipset</b>	<ul style="list-style-type: none"> <li>Intel® Q170 Chipset</li> </ul>
<b>Memory</b>	Two 260-pin SODIMM <ul style="list-style-type: none"> <li>Supports dual-channel DDR4 1866/2133MHz</li> <li>Supports up to 32GB system memory</li> </ul>
<b>Graphics</b>	Intel® HD Gen 9 Graphics OpenGL 5.0, DirectX 12, OpenCL 2.1 <ul style="list-style-type: none"> <li>Supports these codecs: HW Decode: AVC/H.264, MPEG2, VC1/WMV9, JPEG/MJPEG, HEVC/H265, VP8, VP9 HW Encode: MPEG2, AVC/H264, JPEG, HEVC/H265, VP8, VP9</li> <li>Output displays: VGA: resolution up to 1920x1200 @ 60Hz DVI: resolution up to 2560x1600 @ 60Hz HDMI: resolution up to 4096x2160 @ 24Hz or 2560x1600 @ 60Hz DP: resolution up to 4096x2304 @ 60Hz</li> </ul>
<b>Triple/Dual Display</b>	VGA + DVI (DVI-D signal) + HDMI/DP (DP available upon request)
<b>Storage</b>	One 2.5" SATA drive bay <ul style="list-style-type: none"> <li>SATA 3.0 port with data transfer rate up to 6Gb/s</li> </ul>
<b>Ethernet</b>	One Intel® I211AT PCIe (10/100/1000Mbps) One Intel® I219LM with iAMT11.0 PCIe (10/100/1000Mbps) (only Core i7/i5 supports iAMT)
<b>Expansion</b>	One full-size Mini PCIe (PCIe/USB) One half-size Mini PCIe (USB/mSATA) One CFast card slot

<b>Front Panel I/O Ports</b>	<ul style="list-style-type: none"> <li>Front Panel <ul style="list-style-type: none"> <li>One power button with LED</li> <li>One reset button</li> <li>One status and one HDD LED</li> <li>Two USB 2.0 Type A ports</li> <li>One remote power-on/power-off connector</li> <li>Two RS-232/422/485 (DB-9) (RS-232 with power)</li> <li>Two RS-232/422/485 (DB-9)</li> </ul> </li> <li>Rear Panel <ul style="list-style-type: none"> <li>Two RJ45 LAN ports</li> <li>One VGA port/one DVI (DVI-D signal)/one HDMI or DP (DP available upon request)</li> <li>Four USB 3.0 Type A ports</li> <li>One Line-out and one Mic-in Ports</li> <li>One CFast card slot</li> <li>One 9~36V DC-in 3-pole terminal block</li> </ul> </li> </ul>
<b>Power</b>	<ul style="list-style-type: none"> <li>Power input voltage: 9~36V DC-in (terminal block type connector)</li> </ul>
<b>Cooling System</b>	<ul style="list-style-type: none"> <li>Fanless with heatsink</li> </ul>
<b>Environment</b>	<ul style="list-style-type: none"> <li>Operating Temperature: 0 to 45°C (SSD/mSATA, w/ 0.7m/sec air flow)</li> <li>Storage Temperature: -20 to 85°C</li> <li>Relative Humidity: 5 to 95% RH (non-condensing)</li> <li>Shock: Half sine wave 3G, 11ms, 3 shock per axis</li> </ul>
<b>Construction</b>	<ul style="list-style-type: none"> <li>Aluminum + SGCC</li> </ul>
<b>Mounting</b>	<ul style="list-style-type: none"> <li>Wall mount <ul style="list-style-type: none"> <li>Mounting brackets and screws* (optional)</li> </ul> </li> </ul>
<b>Dimensions</b>	<ul style="list-style-type: none"> <li>235mm x 63.2mm x 221.2mm (W x H x D)</li> </ul>
<b>Weight</b>	<ul style="list-style-type: none"> <li>3.5 kg</li> </ul>
<b>OS Support</b>	<ul style="list-style-type: none"> <li>Windows 7 (32/64-bit)</li> <li>Windows 8.1 (64-bit)</li> <li>Windows 10</li> </ul>
<b>Other Features</b>	System Reset, Programmable via Software from 1 to 255 Seconds
<b>Standards and Certifications</b>	IEC68-2-64

**Note:**

\* Optional and is not supported in standard model. Please contact your sales representative for more information.

## Getting to Know the EC500-SD

### Front View

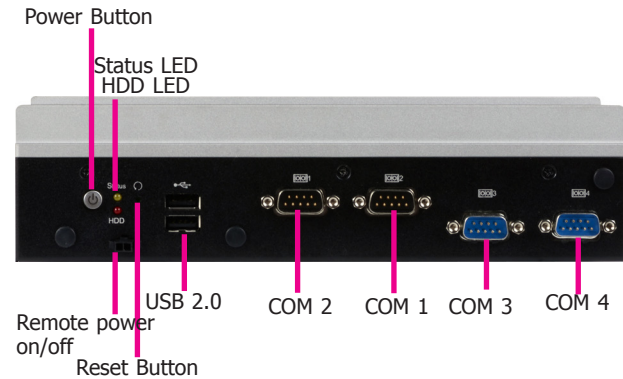

#### Power button with LED (Green)

Press to power on or power off the system.

#### Reset Button

Press to reset the system.

#### HDD LED (Red)

Indicates the status of disk drives as below.

HDD LED		
HDD State	Disk access activity	Disk drives present or not present
LED Behavior	Blink	Off

#### Status LED (Yellow)

Indicates system status as below.

Status LED				
Suspend Mode	S0	S1	S3	S4, S5
LED Behavior	Always ON	Quick Blink (cycle 1 sec)	Slow Blink (cycle >1 sec)	Off

#### Remote Power-on/power-off switch connector

Connects distant power on/off switch.

#### USB 2.0 Ports

Connect USB 2.0 and 1.1 devices.

#### COM Ports

All COM ports can be selected among RS232, RS422 and RS485. COM1 and COM2 can be selected between RS232 and RS232 with power via jumper settings.

### Rear View

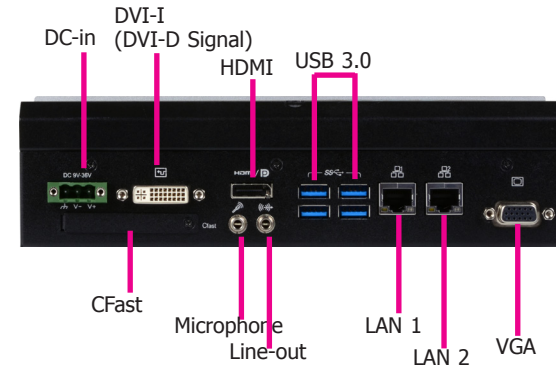

#### DC-in

DC 9~36V power input via a terminal block connector.

#### CFast

The CFast card slot complies with CFast 2.0 and can accommodate both Type I (3.3mm) and Type II (5mm) cards.

#### DVI-I (DVI-D signal)

Connects the DVI-I connector of an LCD monitor.

#### HDMI (or DP)

Connects the HDMI connector of an LCD monitor.

#### Microphone/Line-out Ports

Connect to audio devices such as microphones and speakers.

#### USB 3.0 Ports

Connect USB 3.0 devices as well as devices based on previous USB versions.

#### Gigabit LAN Ports

Connects the system to a local area network.

#### VGA Connector

Connects the VGA connector of a monitor.



### Mechanical Dimensions

#### Chassis Dimensions

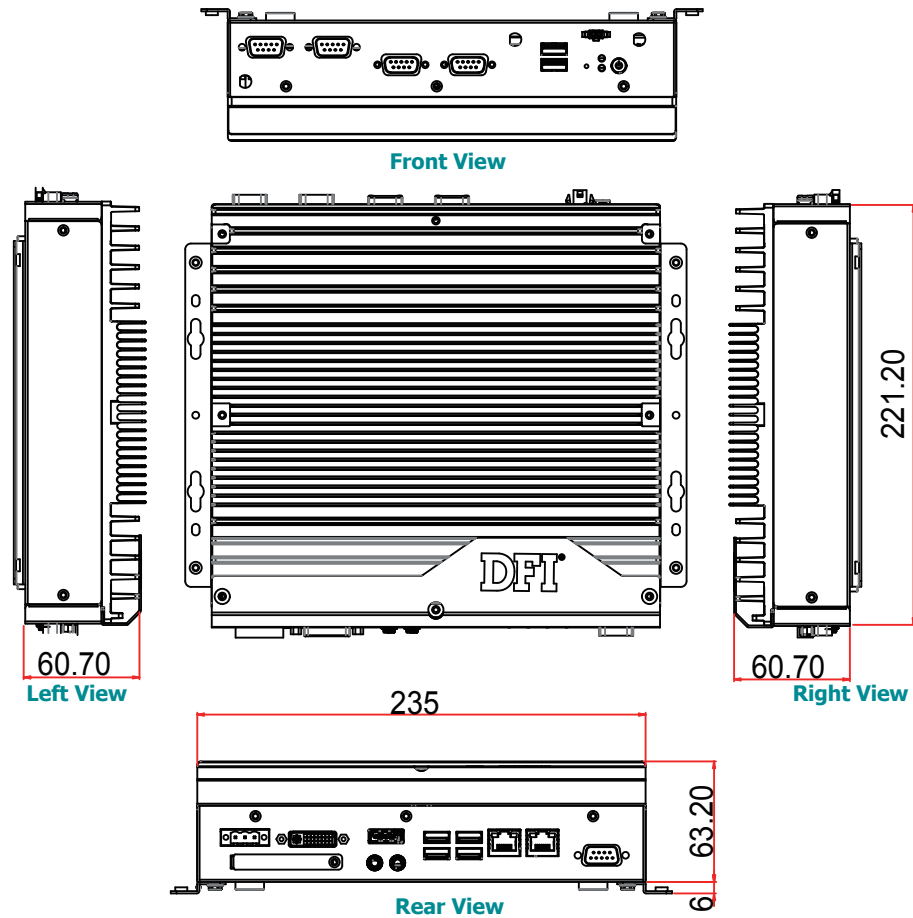

#### Motherboard Dimensions

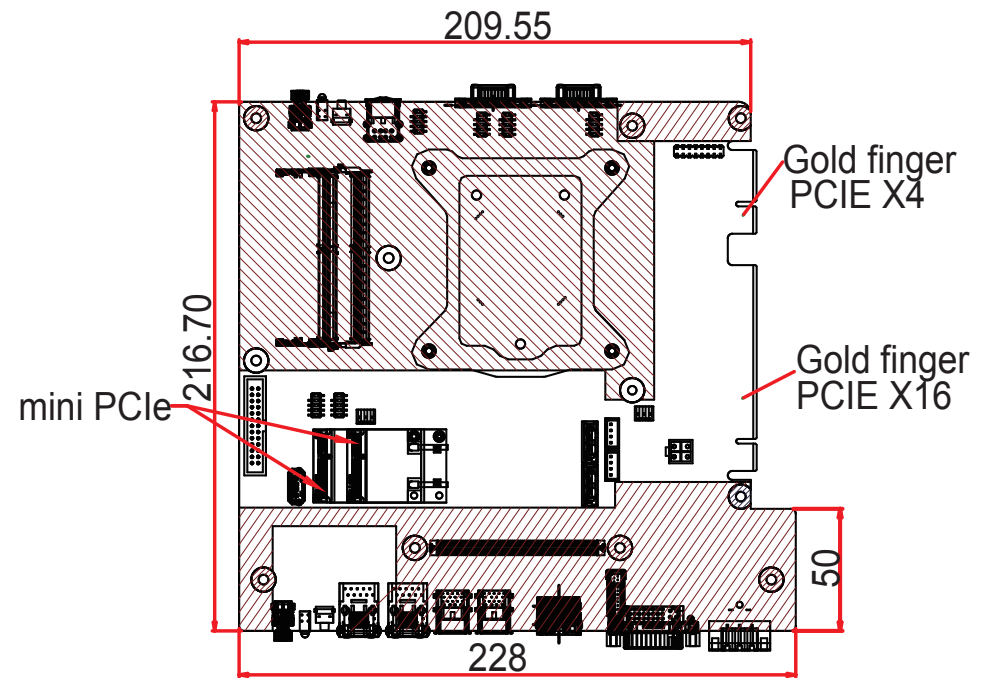

## Chapter 2 - Getting Started

---

### Preparing the System

Before you start using the system, you need the following items:

- SATA hard drive
- AC power adapter
- Optical drive (for installing software/drivers)
- Memory module

### Installing Devices

The following are devices that can be installed in the system.

- Memory module
- SATA hard drives
- Mini PCIe and mSATA card
- CFast card

### Configuring the BIOS

To get you started, you may need to change configurations such as the date, time and the type of hard disk drive.

1. Power-on the system.
2. After the memory test, the message "Press DEL to run setup" will appear on the screen.  
Press the Delete key to enter the BIOS setup utility.

### Installing an Operating System

Most operating system software can be installed using a DVD (and DVD burner) or bootable USB drive.

Please refer to your operating system manual for instructions on installing an operating system.

### Installing the Drivers

The system requires you to install drivers for some devices to operate properly. Refer to the Supported Software chapter for instructions on installing the drivers.

## Chapter 3 - Installing the Devices

### Removing the Chassis Cover

1. Make sure the system and all other peripherals connected to it have been powered off.
2. Disconnect all power cords and cables.
3. The 6 mounting screws on the left and right sides and bottom of the system are used to secure the cover to the chassis. Remove these screws and put them in a safe place for later use.

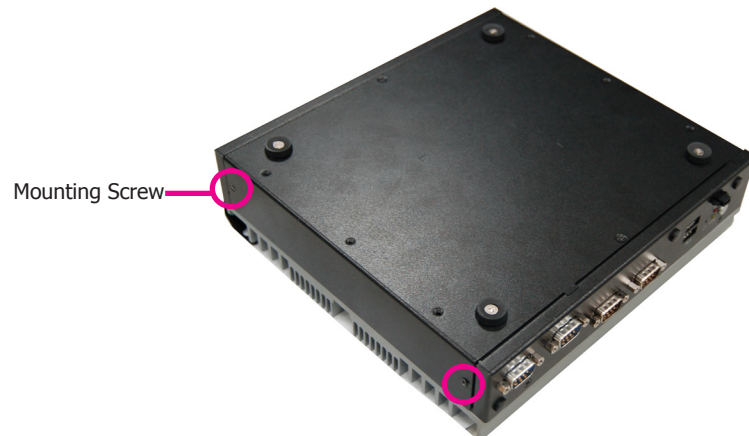
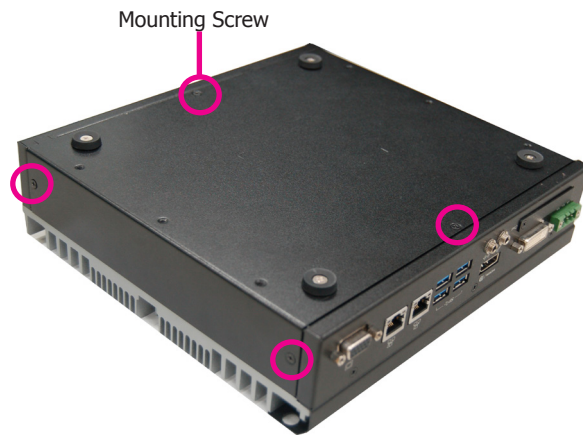

4. Lift the cover upward to open the system.



5. The SODIMM sockets, Mini PCIe slot and SATA drive bay are accessible after removing the chassis cover.

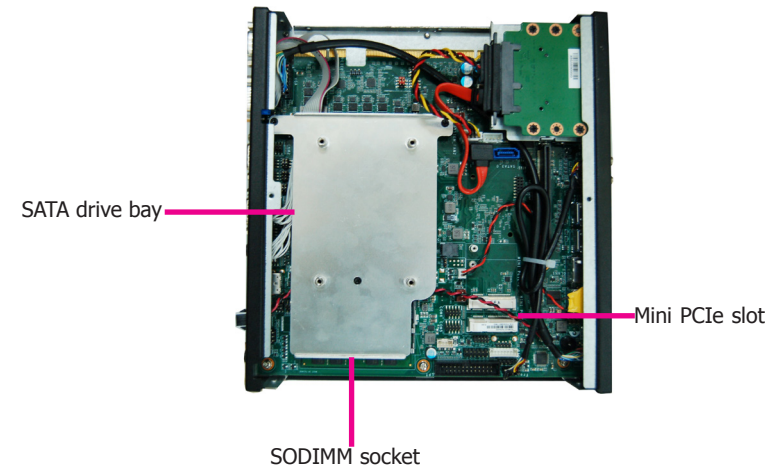

## Installing a SODIMM

1. The SODIMM sockets are located on the system board. Remove the SATA drive bay to access the SODIMM sockets.

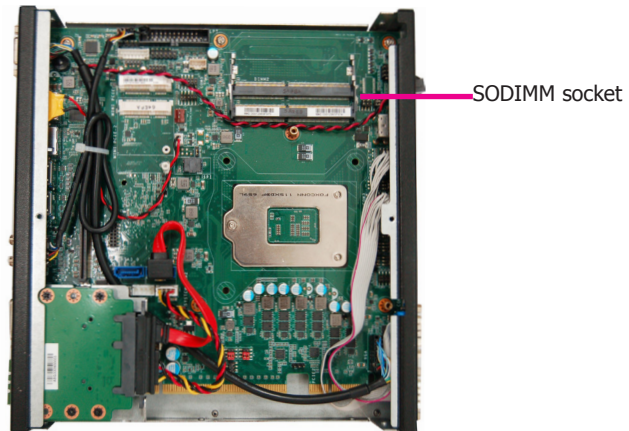
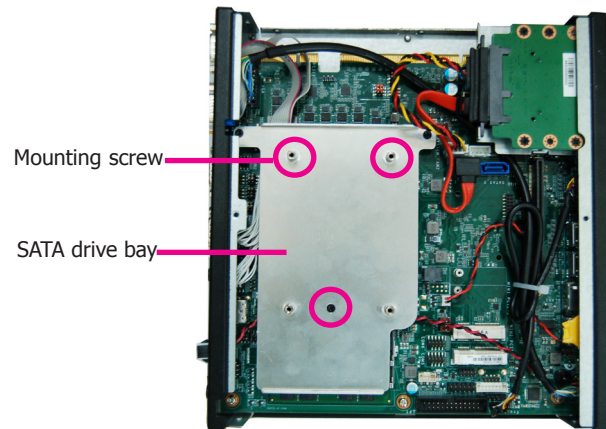

2. Grasp the module by its edges and align the memory's notch with the socket's notch; then insert the memory into the socket at an angle and push it down until you feel a click.

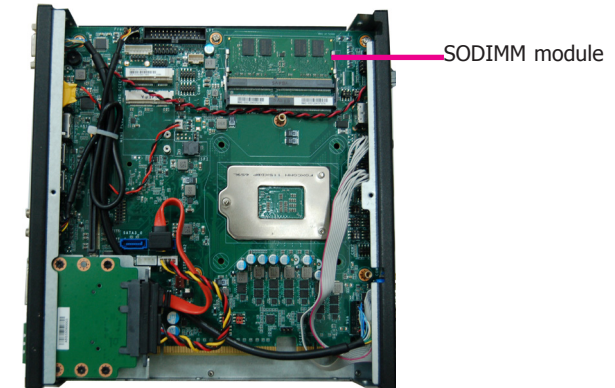

### Notes:

1. The system supports dual-channel configuration. To enable dual-channel, populate both SODIMM sockets.
2. The SODIMM sockets can only accept DDR4 memory modules. Please do not install other types of memory modules.

## Installing a 2.5" SATA Drive

1. Before installing the SATA drive, connect the SATA data and power cable to the SATA data connector of the SATA drive. Then install the SATA drive on the HDD bracket with the provided mounting screws from the HDD drive bay kit.

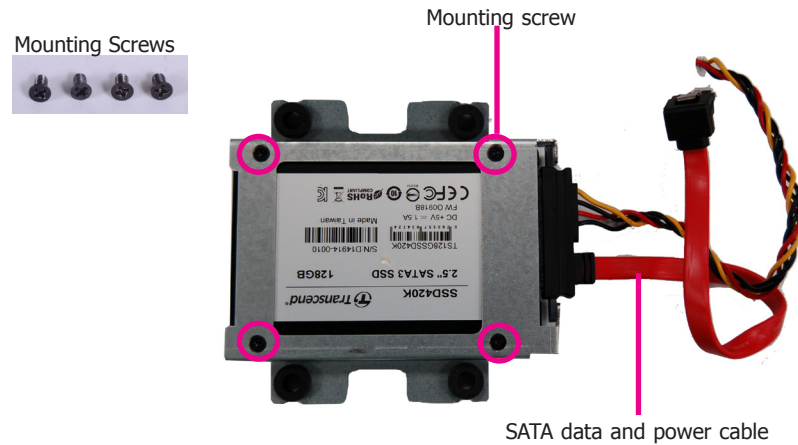

2. Place the SATA drive installed with the HDD bracket in the system. Align the mounting holes on the HDD bracket with the mounting holes on the drive bay and use the provided mounting screws to secure the drive in place.

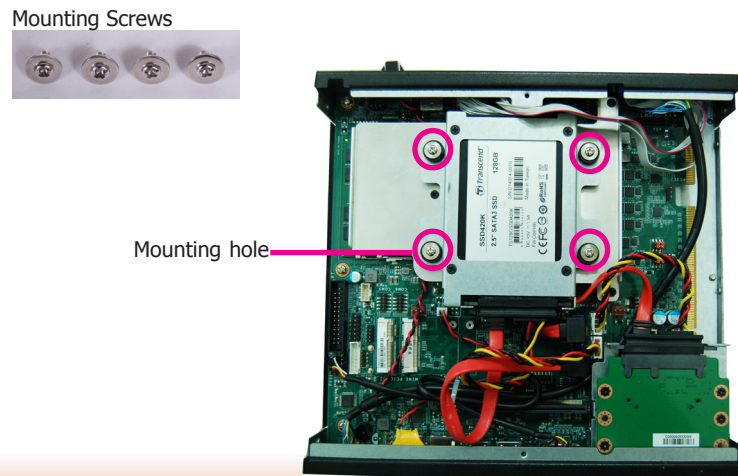

3. Connect the other end of the SATA data and power cable to the SATA data and power connectors on the system board respectively.

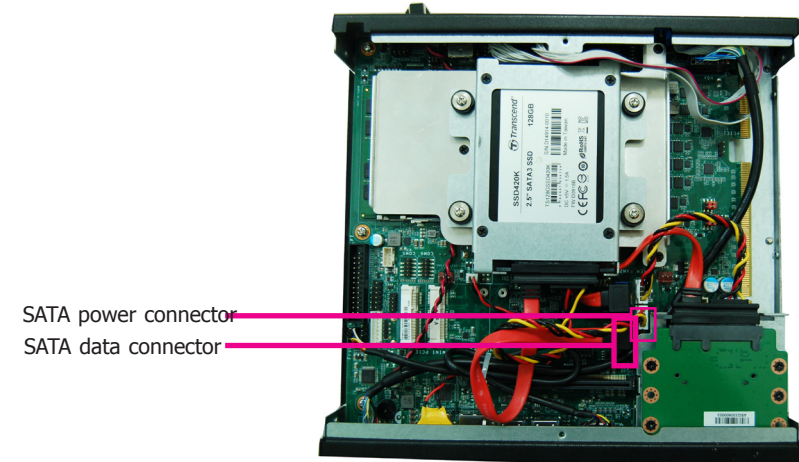

## Installing a CFast Card

1. Before installing a CFast card, take off the CFast card slot cover.



2. Gently insert the CFast card straight with the label on the CFast card facing up until you feel it lock into place. Do not force the card into the slot if the card is not correctly inserted.

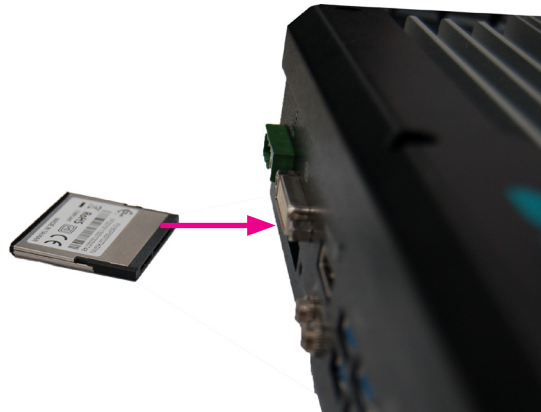

3. Close the CFast card cover. To eject the card, push the card inward to release the lock and pull it out.

## Installing a Mini PCIe or mSATA Card

The system board is equipped with 2 Mini PCIe slots: one full-size and (PCIe/USB signals) and one half-size slot (USB/mSATA signals). Here we will demonstrate the installation of a full-size Mini PCIe card.

1. Grasp the Mini PCIe card by its edges and align the notch in the connector of the Mini PCIe card with the notch in the connector on the system board.

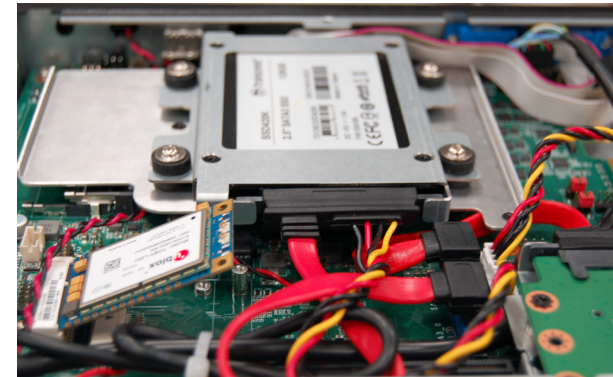

2. Push the Mini PCIe card down and use the provided mounting screw to secure the card on the system board.

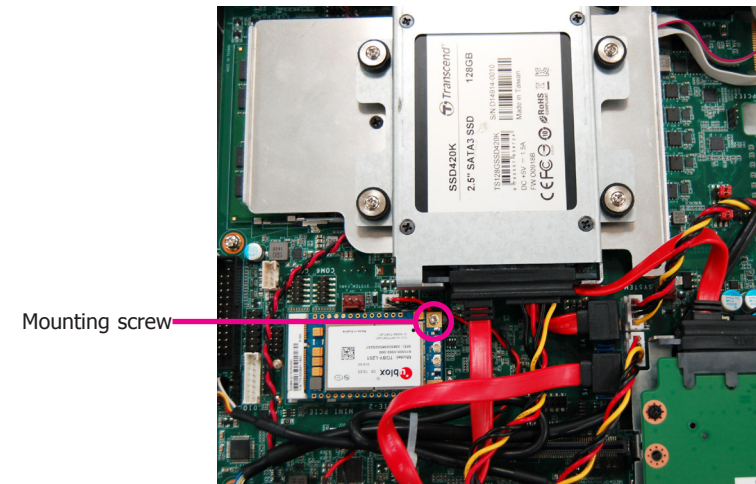

**Important:** The bottom side of a full-size Mini PCIe module should have a component height restriction of 0.82 mm and will sit flush against the connected half-size Mini PCIe module if such a component is used and the half-size slot is connected with a module.

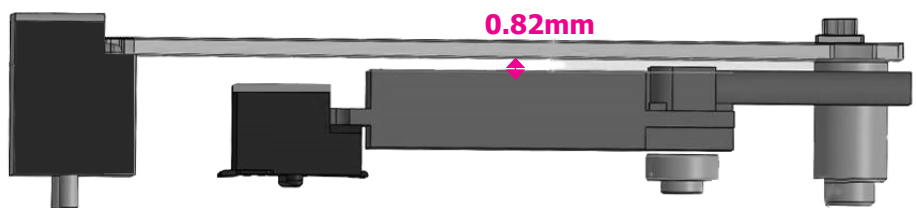

## Installing a CPU

1. Make sure the system and all other peripheral devices connected to it have been powered-off.
2. Disconnect all power cords and cables.
3. Before installing the Intel CPU, remove the 8 mounting screws on the top of the system unit and put them in a safe place for later use.

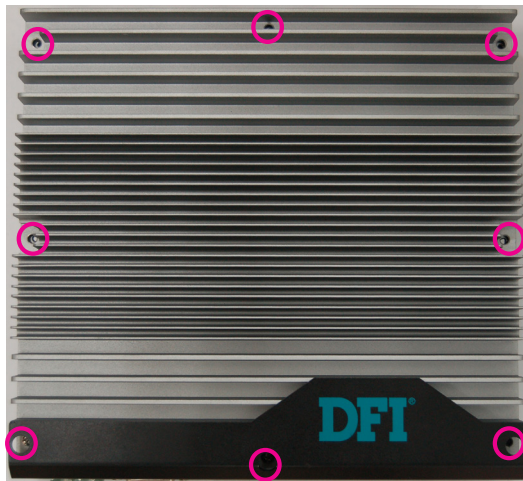

4. The system board is equipped with a surface mount LGA 1151 socket. This socket is exclusively designed for installing a LGA 1151 packaged Intel CPU.



### Important:

1. Before you proceed, make sure (1) the LGA 1151 socket comes with a protective cap, (2) the cap is not damaged and (3) the socket's contact pins are not bent. If the cap is missing or the cap or contact pins are damaged, contact your dealer immediately.
  2. Keep the protective cap. RMA requests will be accepted and processed only if the LGA 1151 socket comes with the protective cap.
5. Unlock the socket by pushing the load lever down, move it sideways until it is released from the retention tab, and then lift the load lever up.

6. Remove the protective cap from the CPU socket. The cap is used to protect the CPU socket against dust and harmful particles. Remove the protective cap only to install the CPU.
7. Insert the CPU into the socket. The gold triangular mark on the CPU must align with the corner of the CPU socket as the photo shown below.
8. Unlock the socket by pushing the load lever down and moving it sideways until it is released from the retention tab and then lift the load lever up.

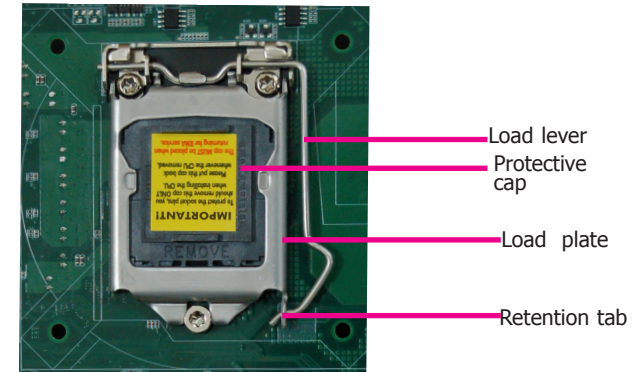

9. Insert the CPU into the socket. The gold triangular mark on the CPU must align with the corner of the CPU socket as shown below. The CPU's notch will at the same time fit into the socket's alignment key.

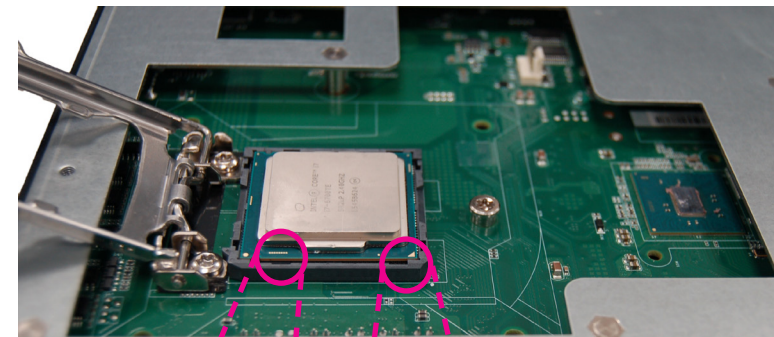

Alignment key — Gold triangular mark



**Important:**

The CPU will fit in only one orientation and can easily be inserted without exerting any force.

10. Close the load plate and push the load lever down to lock it under the retention tab. While closing the load plate, slide the front edge of the load plate under the retention tab.

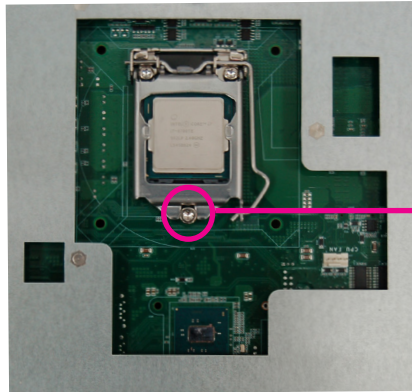

Retention knob

## Chapter 4 - Jumper Settings

### Clear CMOS Data

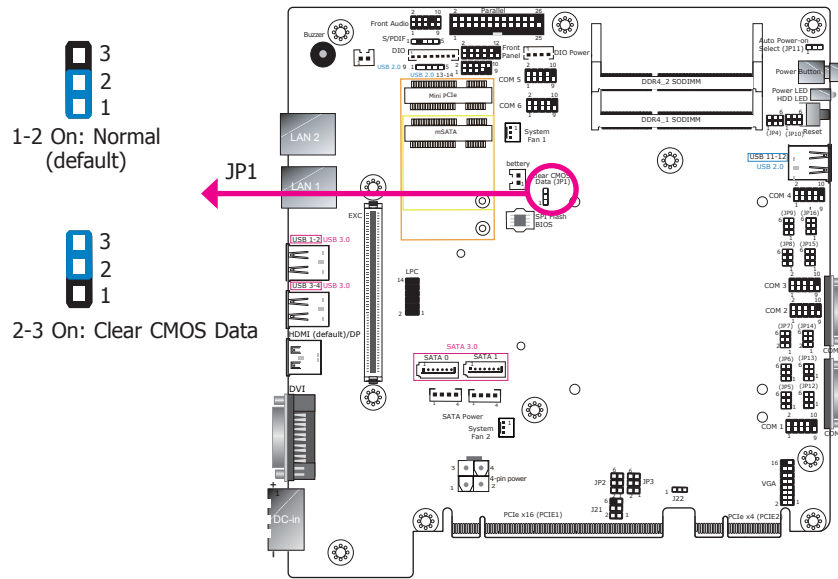

If you encounter the following conditions, you can reconfigure the system with the default values stored in the BIOS ROM.

- CMOS data becomes corrupted.
- You forgot the supervisor or user password.

To load the default values stored in the ROM BIOS, please follow these steps below:

- Power-off the system and unplug the power cord.
- Set the jumper pins 2 and 3 to On. Wait for a few seconds and set the jumper back to its default setting: 1-2 On.
- Now plug the power cord and power on the system.

### Auto Power-on Select

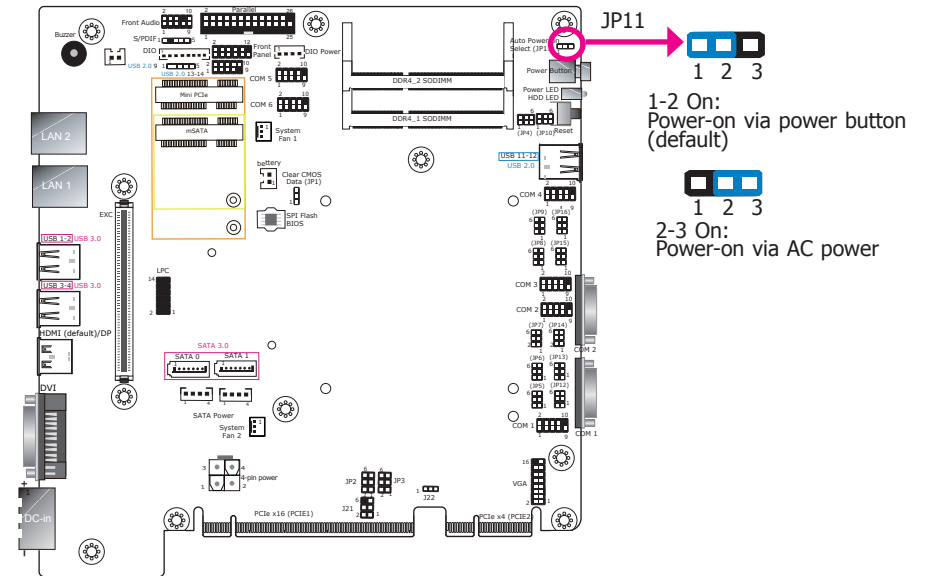

JP11 is used to select the method of powering on the system. If you want the system to power-on whenever AC power comes in, set JP11 pins 2 and 3 to On. If you want to use the power button, set pins 1 and 2 to On.

When using the JP11 "Power On" feature to power the system back on after a power failure, the system may not power on if the power lost is resumed within 5 seconds (power flicker).

## COM1/COM2 RS232 Power Select

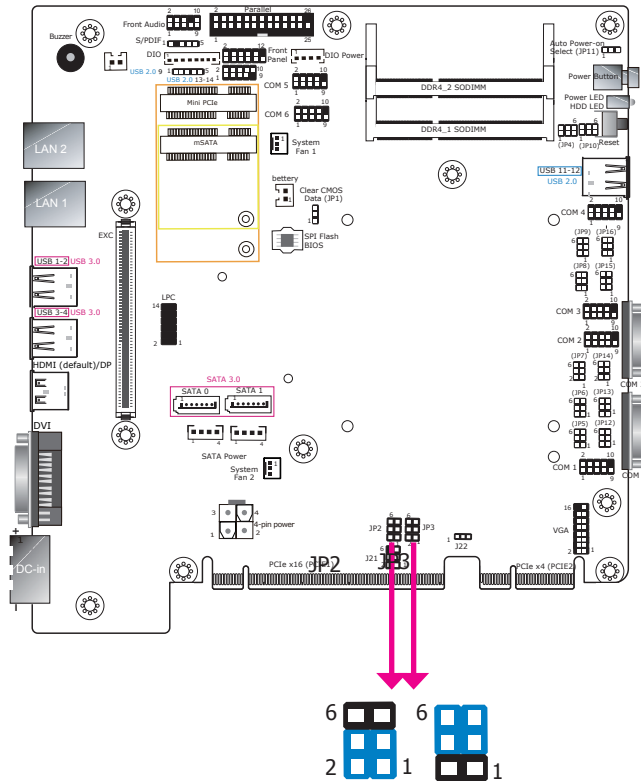

1-3 (RI), 2-4 (DCD) On: RS232 (default)  
 3-5 (+5V), 4-6 (+12V) On: RS232 with power

JP3 (for COM1) and JP2 (for COM2) are used to configure serial COM ports to normal RS232 or RS232 with power. The pin assignments (Pin 1: optional 12V and Pin 9: optional 5V) of COM1 and COM2 will vary according to JP3's and JP2's setting respectively.

## COM1/COM2 RS232/422/485 Select

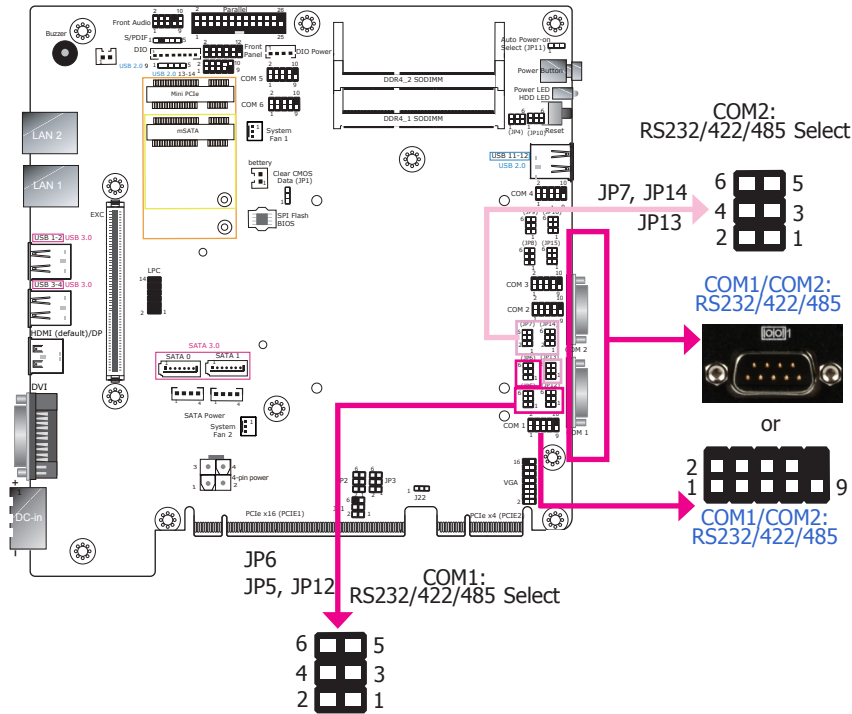

These jumpers allow you to configure the Serial COM ports to RS232, RS422 (full duplex) or RS485. JP5, JP6 and JP12 are used to configure serial COM port 1. JP7, JP13 and JP14 are used to configure serial COM port 2. The pin functions of COM port 1 and COM port 2 will vary according to these jumpers' settings. Both COM1 and COM2 can be wired as either external ports or internal connectors. You can also configure the RS485 auto flow mechanism through the BIOS setup utility. For more information, refer to Chapter 7.

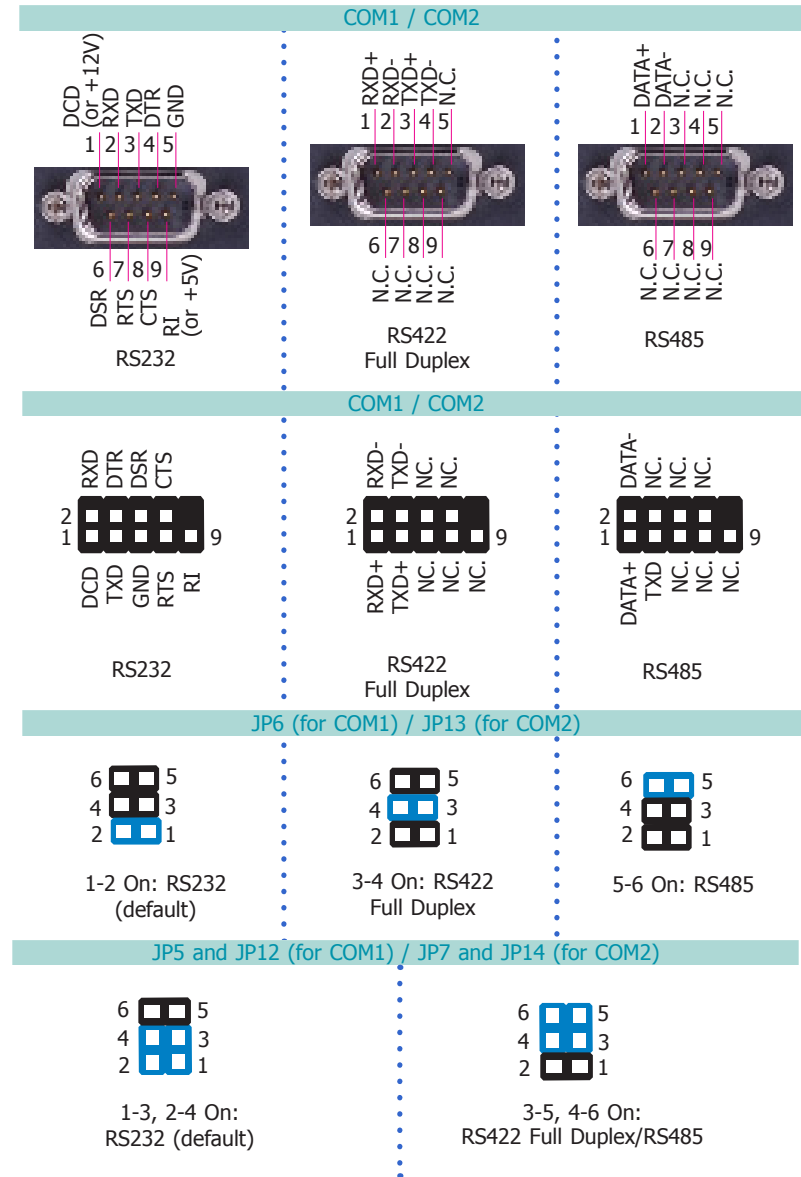

**Note:** When COM1 RS232/422/485 is selected, JP5 and JP12 must be set in accordance to JP6. And when COM2 RS232/422/485 is selected, JP7 and JP14 must be set in accordance to JP13.

### COM3/COM4 RS232/422/485 Select

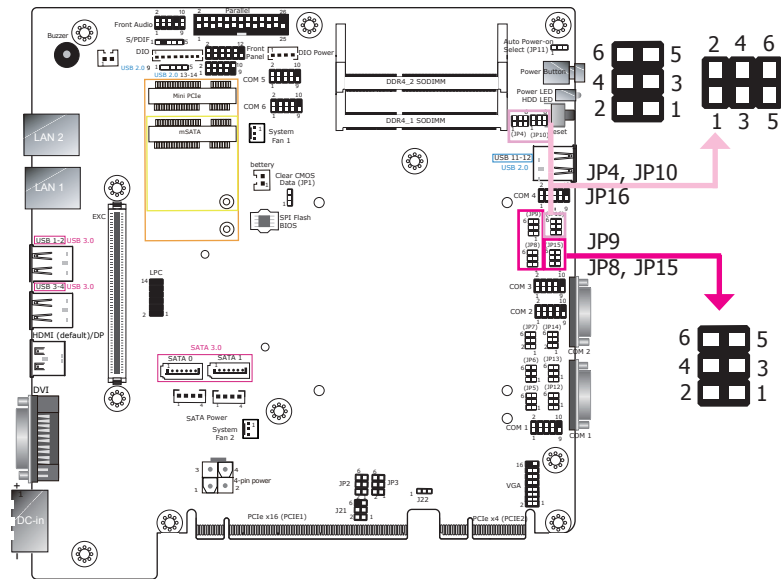

These jumpers allow you to configure the Serial COM ports to RS232, RS422 (full duplex) or RS485. JP8, JP9 and JP15 are used to configure serial COM port 3. JP4, JP10 and JP16 are used to configure serial COM port 4. The pin functions of COM port 3 and COM port 4 will vary according to these jumpers' settings. You can also configure the RS485 auto flow mechanism through the BIOS setup utility. For more information, refer to Chapter 7.

**Note:** When COM3 RS232/422/485 is selected, JP8 and JP15 must be set in accordance to JP9. And when COM4 RS232/422/485 is selected, JP10 and JP16 must be set in accordance to JP4.

#### COM3 / COM4

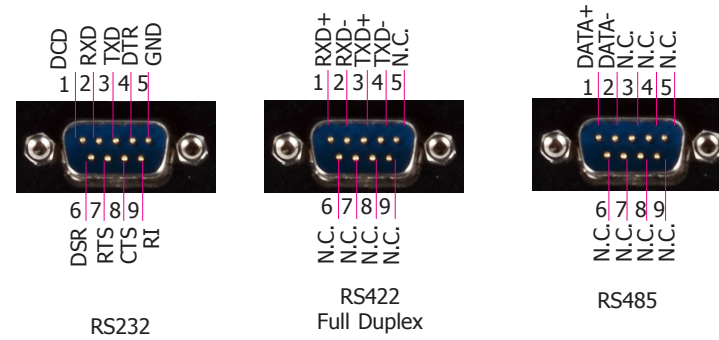

#### COM3 / COM4

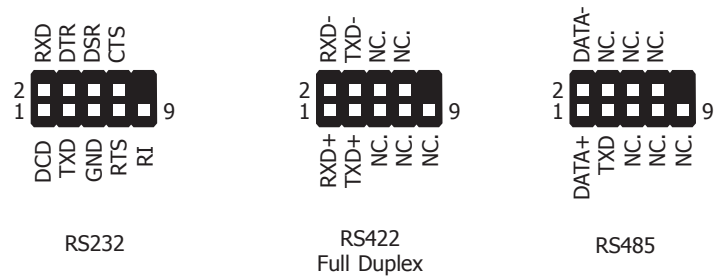

#### JP9 (for COM3) / JP4 (for COM4)

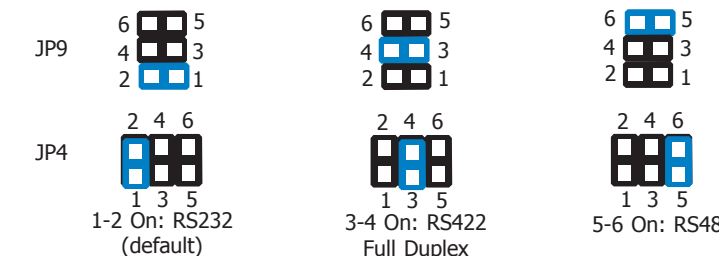

#### JP8 and JP15 (for COM3) / JP10 and JP16 (for COM4)

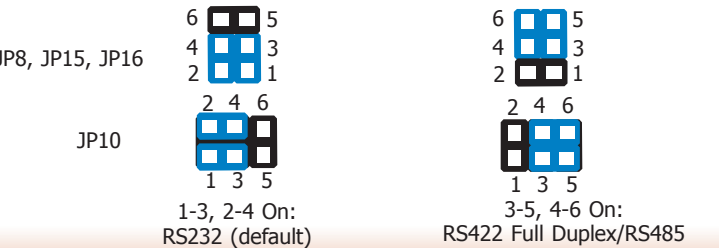

## Chapter 5 - Ports and Connectors

### Front Panel I/O Ports

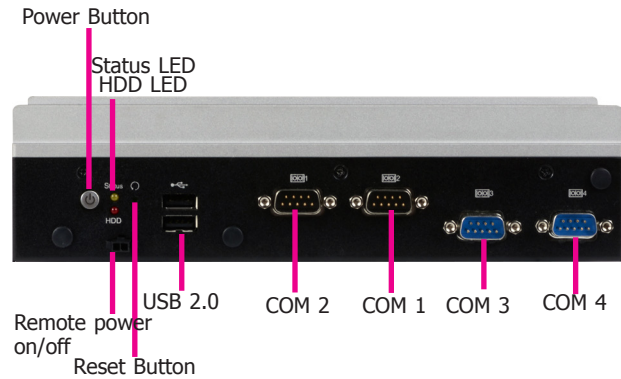

The front panel I/O consists of the following ports:

- Power button with LED
- Reset button
- Remote power on/off switch connector
- Status and HDD LEDs
- Two USB 2.0 ports
- Four RS232 serial ports

### USB Ports

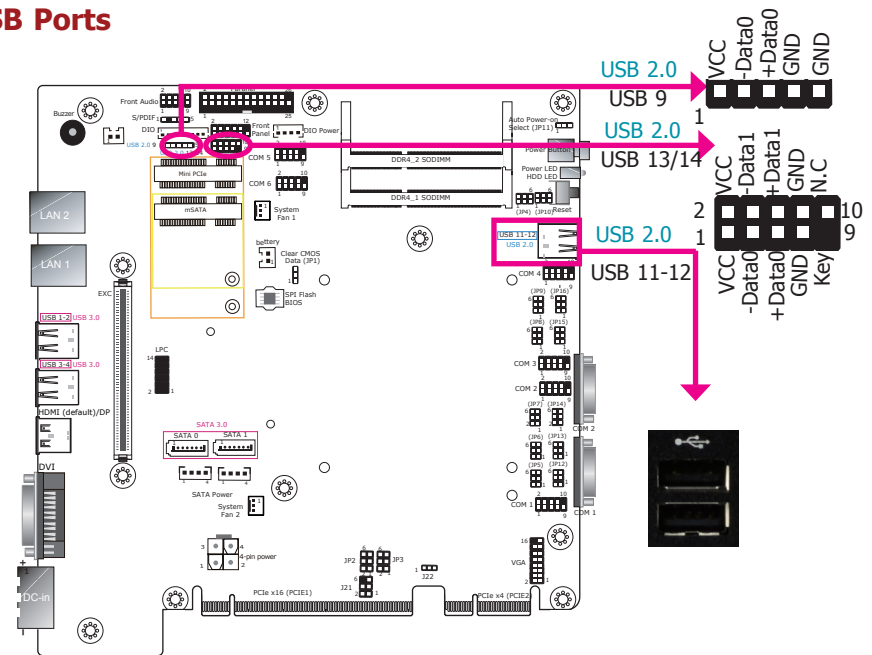

The USB device allows data exchange between your computer and a wide range of simultaneously accessible external Plug and Play peripherals. In addition to the 2 USB 2.0 ports at the front panel, the system board provides 3 USB 2.0 ports through the internal pin headers.

- **BIOS Setting**

Configure the onboard USB in the Advanced menu ("USB Configuration" submenu) of the BIOS. Refer to Chapter 7 for more information.

## COM (Serial) Ports

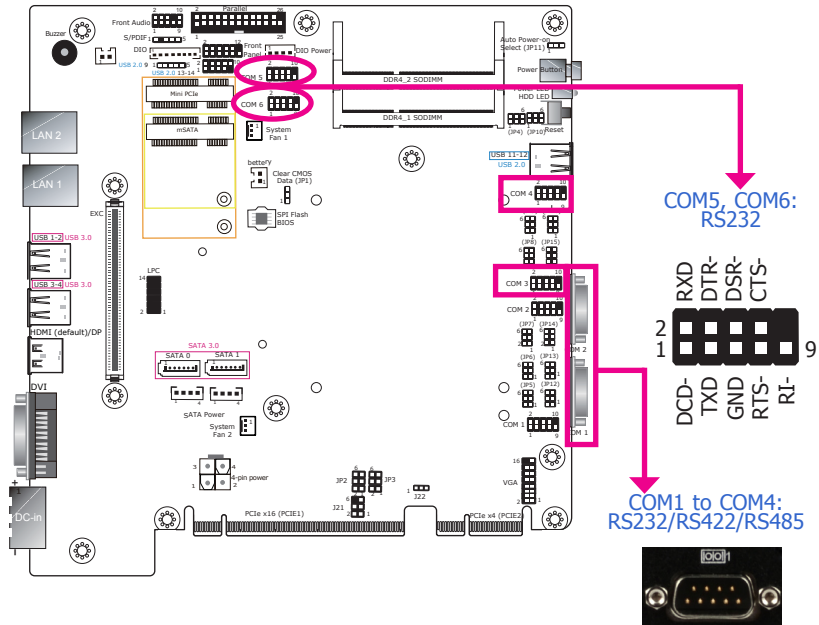

COM1 to COM4 can be selected among RS232, RS422 and RS485 whereas COM5 and COM6 are fixed at RS232. In addition, COM1 and COM2 can be switched between normal RS232 and RS232 with power. For pin definitions and jumper selection of different communication modes, please refer to Chapter 4.

The serial ports are asynchronous communication ports with 16C550A-compatible UARTs that can be used with modems, serial printers, remote display terminals, and other serial devices.

### • BIOS Setting

Configure the serial ports in the Advanced menu ("Super IO Configuration" submenu) of the BIOS. Refer to Chapter 7 for more information.

## Rear Panel I/O Ports

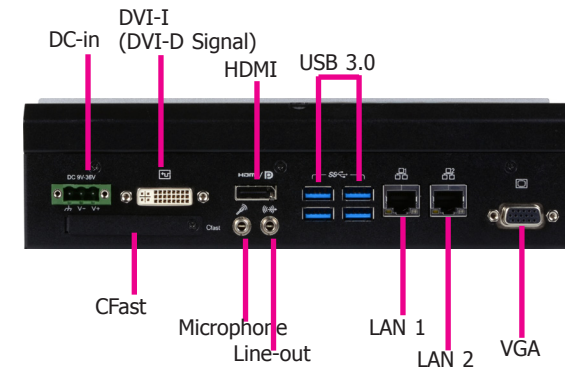

The rear panel I/O consists of the following ports:

- 9~36V DC-in
- CFast card slot
- DVI-I (DVI-D signal)/HDMI (or DP) /VGA connectors
- Line-out and microphone ports
- Four USB 3.0 ports
- Two RJ45 LAN ports

## RJ45 LAN Ports

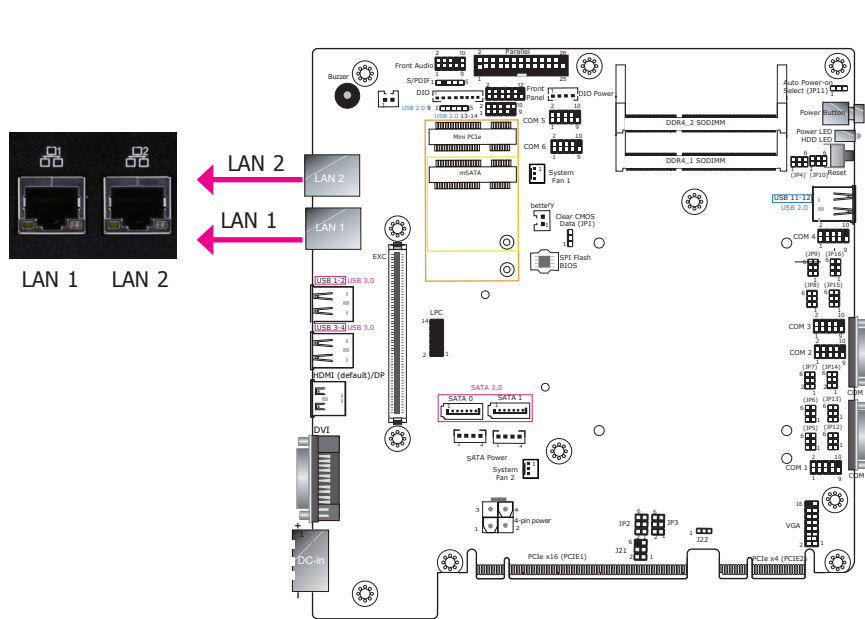

### Features

- LAN1: Intel® I219V PCIe Gigabit Ethernet Controller
- LAN2: Intel® I211AT PCIe Gigabit Ethernet Controller

The LAN ports allow the system board to connect to a local area network with a network hub.

### BIOS Setting

Configure the onboard LAN in the Advanced menu (“ACPI Configuration”) of the BIOS. Refer to Chapter 7 for more information.

### Driver Installation

Install the LAN drivers. Refer to Chapter 8 for more information.

## Display Interfaces

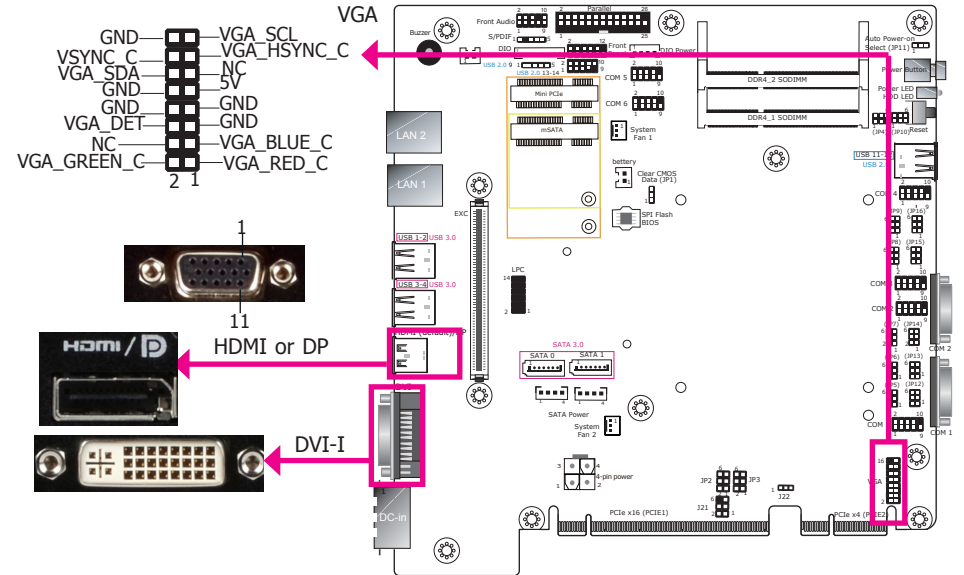

### VGA Port

The VGA port is used for connecting a VGA monitor. Connect the monitor’s 15-pin D-shell cable connector to the VGA port. After you plug the monitor’s cable connector into the VGA port, gently tighten the cable screws to hold the connector in place.

### DVI-I (DVI-D Signal) Port

The DVI-I (DVI-D Signal) port is used to connect a digital LCD monitor to transmit uncompressed digital video. This connector has a DVI-I receptacle but implements DVI-D signals (digital only).

Connect the display device’s cable connector to the DVI-I port. After you plug the cable connector into the DVI-I port, gently tighten the cable screws to hold the connector in place.

### HDMI Port or DisplayPort

The HDMI port which carries both digital audio and video signals is used to connect the HDMI port of an LCD monitor or a digital TV.

### BIOS Setting

Configure the display devices in the Advanced menu (“Video Configuration” submenu) of the BIOS. Refer to the Chapter 7 for more information.

### Driver Installation

Install the graphics driver. Refer to Chapter 8 for more information.



## USB Ports

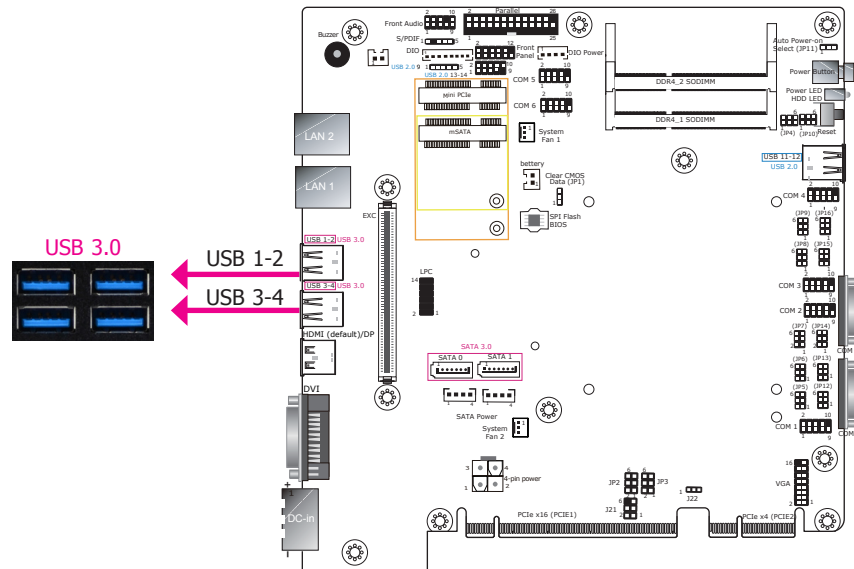

The USB device allows data exchange between your computer and a wide range of simultaneously accessible external Plug and Play peripherals. The system board is equipped with 4 USB 3.0 ports at the rear panel and 2 USB 2.0 ports at the front panel of the system unit. The USB 3.0 can transfer data up to 5 Gbps whereas the USB 2.0 can transfer data up to 480Mbps.

- **BIOS Setting**

Configure the onboard USB in the Advanced menu ("USB Configuration" submenu) of the BIOS. Refer to Chapter 7 for more information.

## 9~36V DC-in

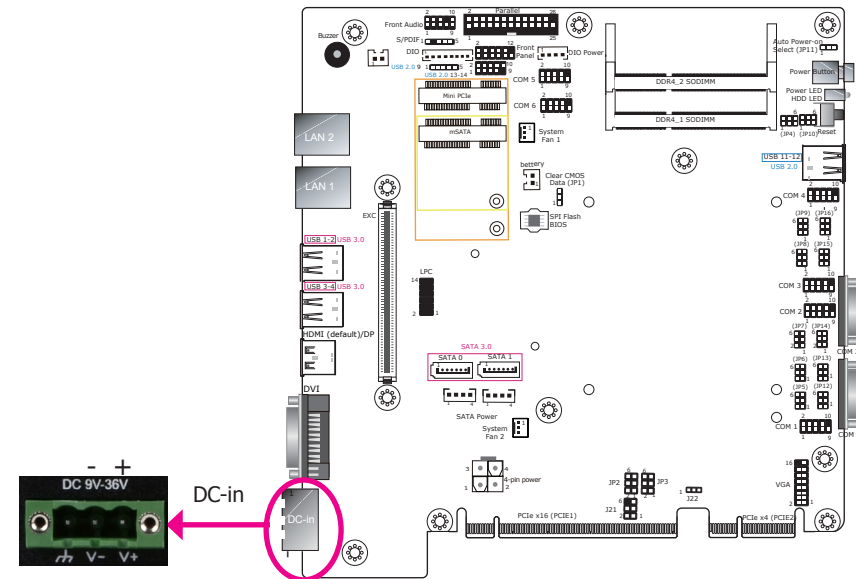

This jack provides options of power input solution of 100W and 120W. Connect a DC power cord to this jack. Using a voltage higher than the recommended one may fail to boot the system or cause damage to the system board.

## Rear Audio Connector

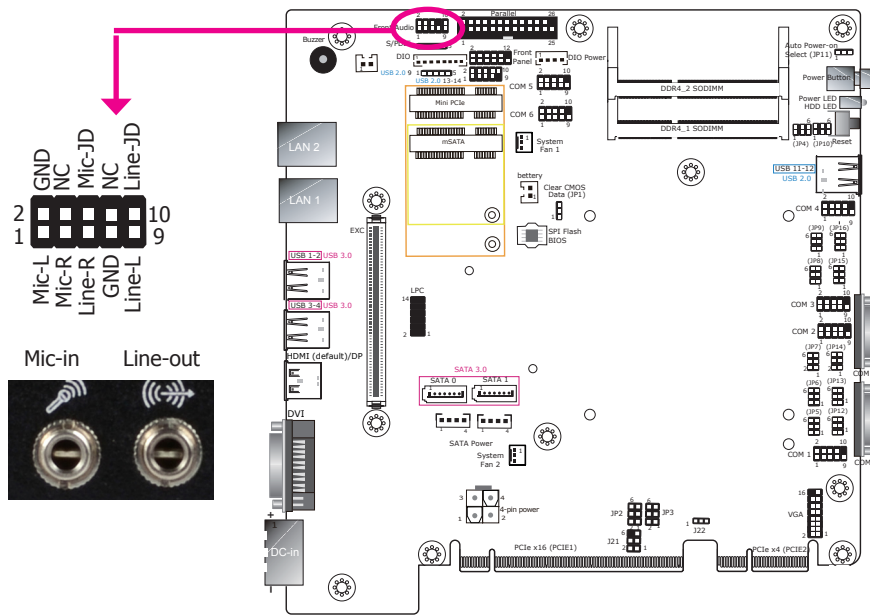

### Rear Audio

The system board is equipped with 2 audio jacks.

- Line-out Jack  
This jack is used to connect a headphone or external speakers.
- Mic-in Jack  
This jack is used to connect an external microphone.

### Driver Installation

Install the audio driver. Refer to the Chapter 8 for more information.

## I/O Connectors

### Parallel Connector

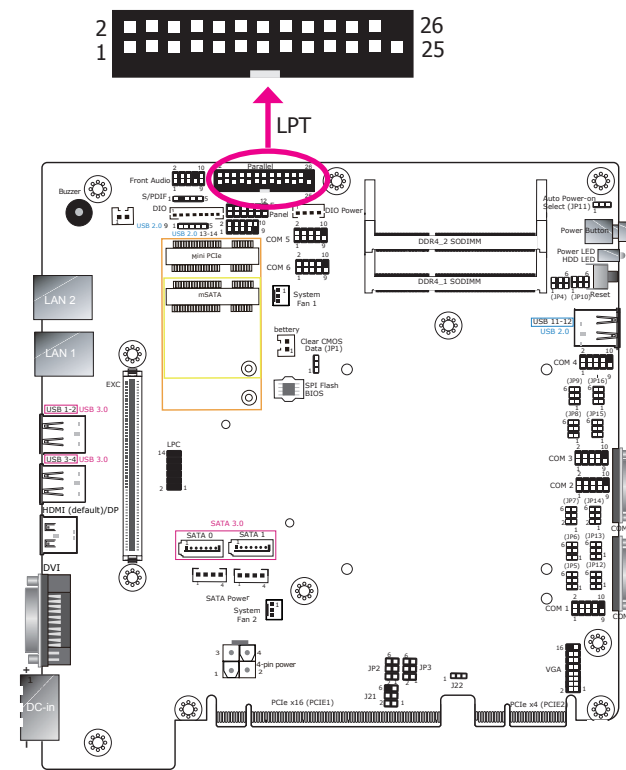

The 25-pin connector is used to connect the parallel port of a device such as a printer. It supports SPP, ECP and EPP standards.

<b>SPP (Standard Parallel Port)</b>	Allows normal speed operation but in one direction only.
<b>ECP (Extended Capabilities Port)</b>	Allows parallel port to operate in bidirectional mode and at a speed faster than the SPP's data transfer rate.
<b>EPP (Enhanced Parallel Port)</b>	Allows bidirectional parallel port operation at the maximum speed.

### Front Panel Connector

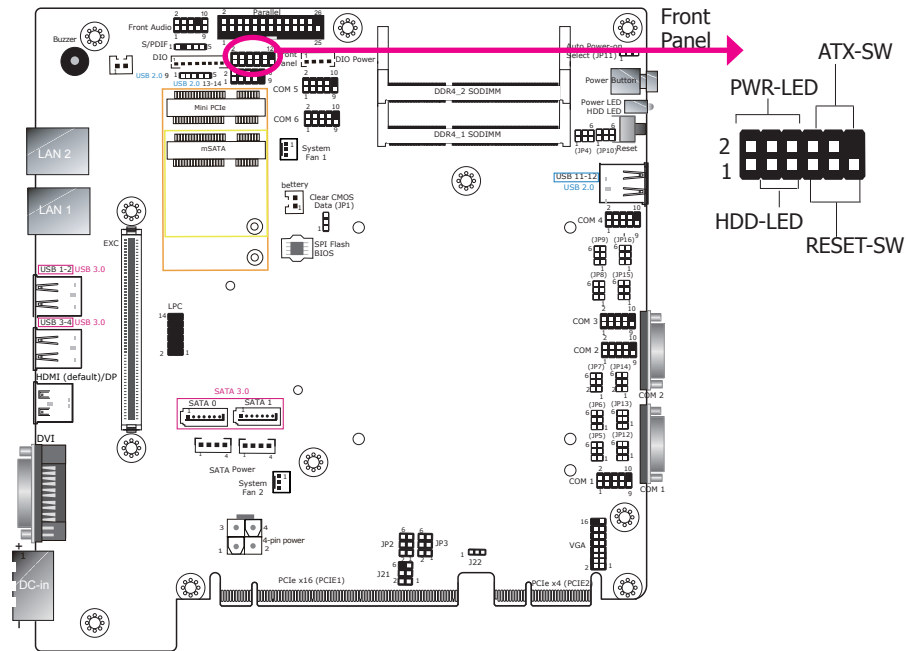

#### HDD-LED - HDD LED

This LED will be lit when the hard drive is being accessed.

#### RESET SW - Reset Switch

This switch allows you to reboot without having to power off the system.

#### ATX-SW - ATX Power Switch

This switch is used to power on or off the system.

#### PWR-LED - Power/Standby LED

When the system's power is on, this LED will be lit. When the system is in the S1 (POS - Power On Suspend) state, it will blink every second. When the system is in the S3 (STR - Suspend To RAM) state, it will blink every 4 seconds.

	Pin	Pin Assignment		Pin	Pin Assignment
<b>HDD-LED</b>	3	HDD Power	<b>PWR-LED</b>	2	LED Power
	5	Signal		4	LED Power
<b>RESET SW</b>	7	Ground	<b>ATX-SW</b>	6	Signal
	9	RST Signal		8	Ground
	11	N.C.		10	Signal

### SATA (Serial ATA) Connectors

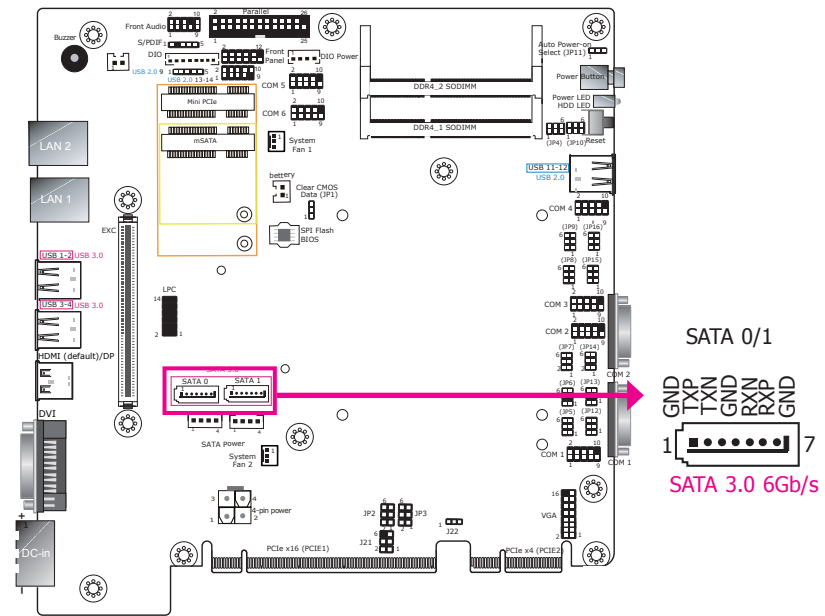

#### Features

- 2 Serial ATA 3.0 ports  
- SATA port 0 and 1 with data transfer rate up to 6Gb/s
- Integrated Advanced Host Controller Interface (AHCI) controller and Intel® Rapid Storage Technology (Intel® RST)

The Serial ATA connectors are used to connect the Serial ATA device. Connect one end of the Serial ATA data cable to the SATA connector on the system board and the other end to your Serial ATA device.

The power cable must be connected from the system board's Serial ATA power connector to a SATA drive's power connector in order to provide power to the drive. Refer to the next page for pin definitions of the SATA power connectors.

#### BIOS Setting

Configure the Serial ATA drives in the Advanced submenu ("SATA Configuration" section) of the BIOS. Refer to Chapter 7 for more information.

## SATA (Serial ATA) Power Connectors

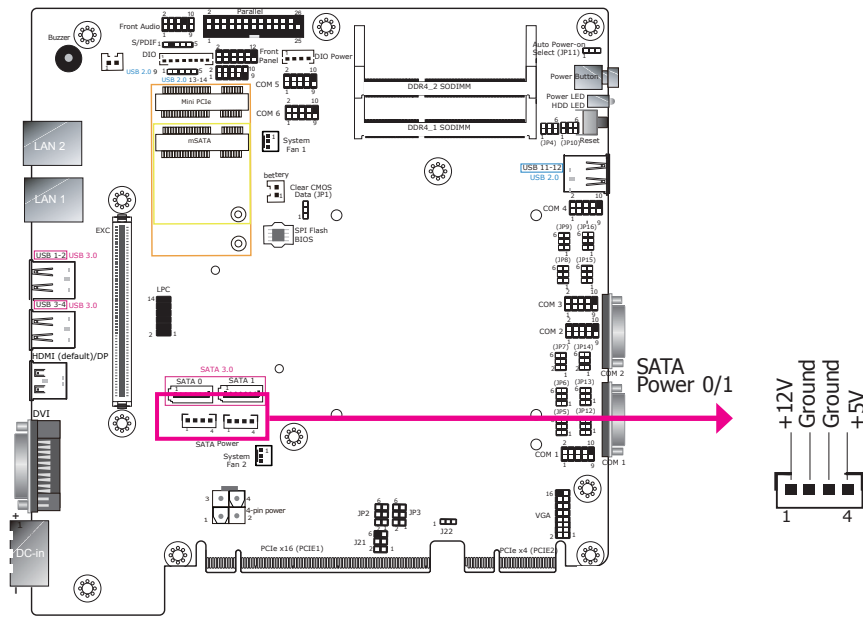

These SATA power connectors supply power to the SATA drives. Connect one end of the provided power cable to the SATA power connector and the other end to your storage device.

## SMBus Connector

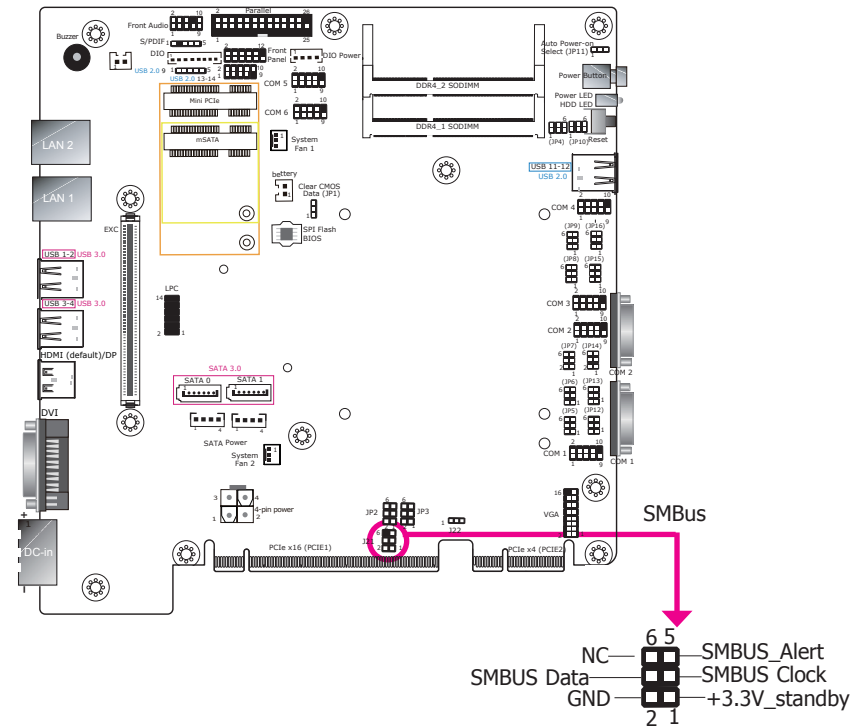

The SMBus (System Management Bus) connector is used to connect SMBus devices. It is a multiple device bus that allows multiple chips to connect to the same bus and enable each one to act as a master by initiating data transfer.

### Cooling Fan Connectors

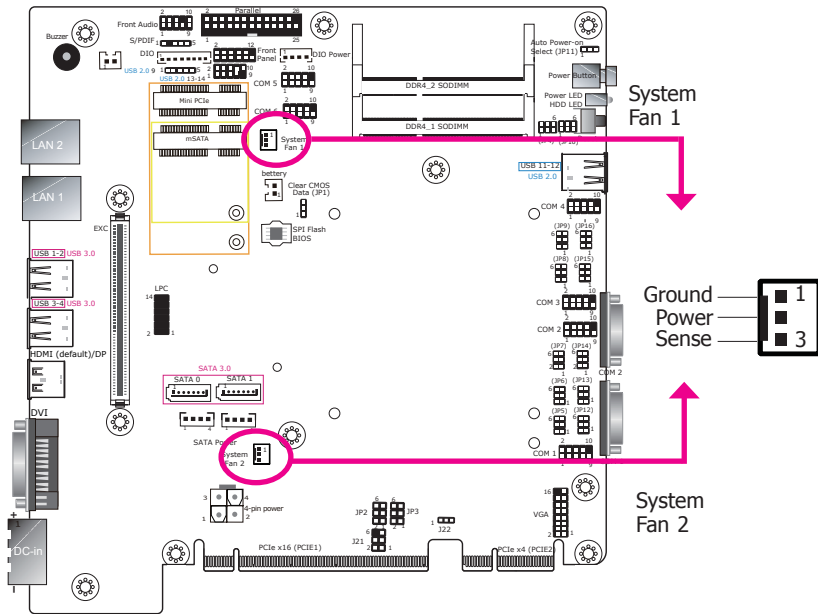

The fan connectors are used to connect cooling fans.

### BIOS Setting

The Super IO menu (“PC Health Status” submenu) of the BIOS will display the current speed of the cooling fans. Refer to Chapter 7 for more information.

### Digital I/O Connector

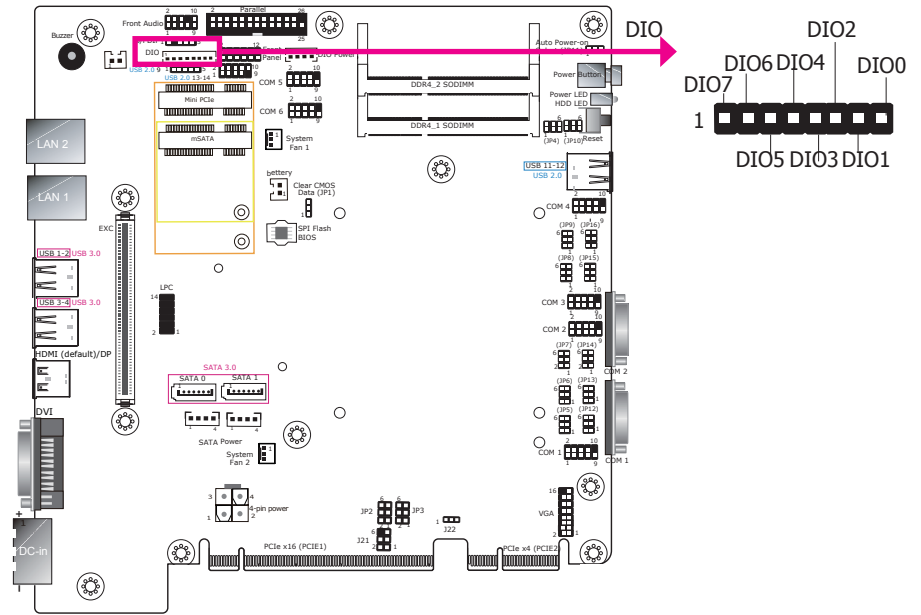

The Digital I/O connector provides 8-bit digital inputs or outputs to enable monitor and control of the states of the connected external devices. You can use the provided HW Utility to configure a port to be either input or output.

### Digital I/O Connector

Pins	Function
1	DIO7
2	DIO6
3	DIO5
4	DIO4
5	DIO3
6	DIO2
7	DIO1
8	DIO0

### S/PDIF Connector

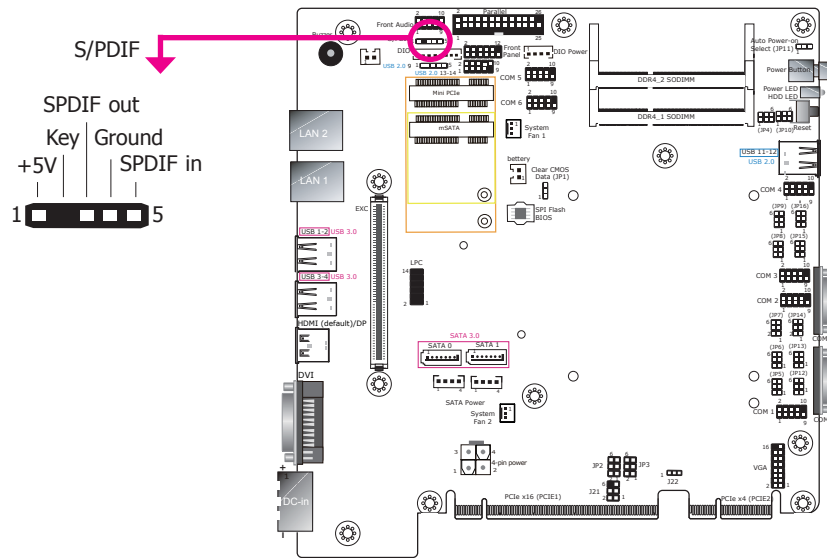

The S/PDIF connector is an audio interface for transmitting digital audio signals. The system includes an S/PDIF header on the board. Make sure pin 1 of the audio cable is aligned with pin 1 of the S/PDIF connector.

### LPC Connector

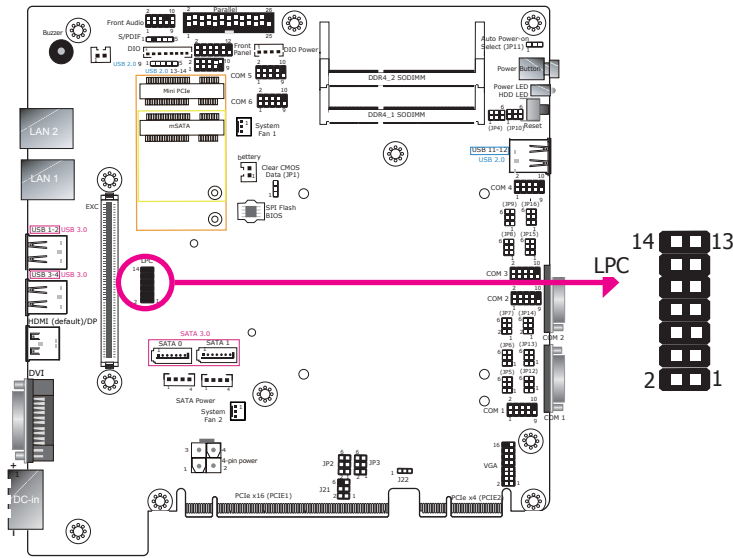

The Low Pin Count Interface was defined by Intel® Corporation to facilitate the industry's transition towards legacy free systems. It allows the integration of low-bandwidth legacy I/O components within the system, which are typically provided by a Super I/O controller. Furthermore, it can be used to interface firmware hubs, Trusted Platform Module (TPM) devices and embedded controller solutions. Data transfer on the LPC bus is implemented over a 4 bit serialized data interface, which uses a 24MHz LPC bus clock. For more information about LPC bus refer to the Intel® Low Pin Count Interface Specification Revision 1.1'. The table below indicates the pin assignments of the LPC connector.

Pin	Pin Assignment	Pin	Pin Assignment
1	L_CLK	2	L_AD1
3	L_RST#	4	L_AD0
5	L_FRAME#	6	3V3
7	L_AD3	8	GND
9	L_AD2	10	Key
11	INT_SERIRQ	12	GND
13	5VSB	14	5V

## Expansion Slots

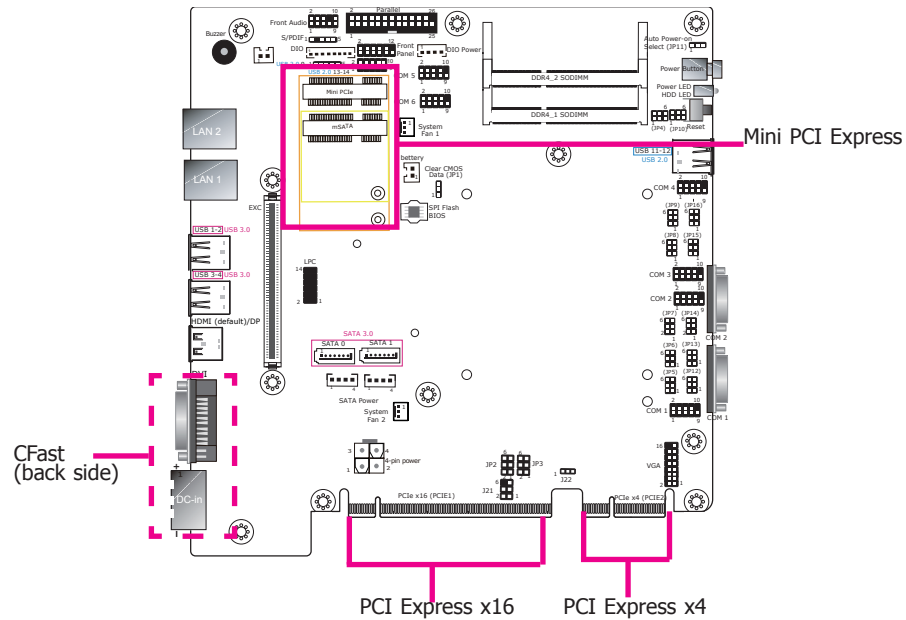

### Mini PCIe Slot

The Mini PCIe socket is used to install a Mini PCIe card. The system is equipped with a full-size Mini PCIe slot (PCIe/USB signals) and a half-size Mini PCIe (mSATA/USB signals) slot. Supporting both USB and mSATA signals, the half-size Mini PCIe slot can be used to expand the system's storage capacity or provide mobile communication capability.

### PCI Express x16 Slot/PCI Express x4 Slot

Install a PCIe x16 or x4 expansion card such as network cards that comply to the PCI Express specifications into this slot.

### CFast

The CFast card slot complies with CFast 2.0 can accommodate both Type I (3.3mm) and Type II (5mm) cards for convenient system capacity expansion. Note that CFast cards are not physically or electrically compatible with CompactFlash cards.

## ECX Slot

The ECX interface is used to install an ECX card for I/O expansion via a proprietary daughter board.

Pin	Pin Assignment	Pin	Pin Assignment
1	GND	2	GND
3	PCIE_ECX_RX1p	4	PCIE_ECX_RX2p
5	PCIE_ECX_RX1n	6	PCIE_ECX_RX2n
7	PCIE_ECX_TX1n	8	PCIE_ECX_TX2n
9	PCIE_ECX_TX1p	10	PCIE_ECX_TX2p
11	CLK_PCIE_ECX1_p	12	CLK_PCIE_ECX2_p
13	CLK_PCIE_ECX1_n	14	CLK_PCIE_ECX2_n
15	Reserved	16	Reserved
17	Reserved	18	Reserved
19	GND	20	GND
21	CLK_PCIE_ECX3_p	22	PCIE_ECX_RX5p
23	CLK_PCIE_ECX3_n	24	PCIE_ECX_RX5n
25	GND	26	PCIE_ECX_TX5n
27	Reserved	28	PCIE_ECX_TX5p
29	DPB_AUX_n	30	CLK_PCIE_ECX5_p
31	DPB_AUX_p	32	CLK_PCIE_ECX5_n
33	Reserved	34	Reserved
35	Reserved	36	Reserved
37	Reserved	38	HD_OUT
39	GND	40	GND
41	DPB_LAN0_n	42	PCIE_ECX_RX4p
43	DPB_LAN0_p	44	PCIE_ECX_RX4n
45	DPB_LAN1_n	46	PCIE_ECX_TX4n
47	DPB_LAN1_p	48	PCIE_ECX_TX4p
49	DPB_LAN2_n	50	CLK_PCIE_ECX4_p
51	DPB_LAN2_p	52	CLK_PCIE_ECX4_n
53	DPC_AUX_n	54	Reserved
55	DPC_AUX_p	56	Reserved
57	DPB_HPD	58	Reserved
59	GND	60	GND
61	DPB_LAN3_n	62	LPC_FRAME#
63	DPB_LAN3_p	64	LPC_AD0
65	DPB_CTRL_CLK	66	LPC_AD1
67	DPB_CTRL_DATA	68	LPC_AD2
69	DPC_CTRL_CLK	70	LPC_AD3
71	DPC_CTRL_DATA	72	LPC_LDRQ1#
73	Reserved	74	DPC_HPD

75	PLT-RST#	76	CLK_LPC
77	HD_RST#	78	HD_SPKR
79	GND	80	GND
81	DPC_LAN0_n	82	USB3_RX0n
83	DPC_LAN0_p	84	USB3_RX0p
85	DPC_LAN1_n	86	GND
87	DPC_LAN1_p	88	USB3_TX0n
89	DPC_LAN2_n	90	USB3_TX0p
91	DPC_LAN2_p	92	GND
93	DPC_LAN3_n	94	HD_BITCLK
95	DPC_LAN3_p	96	HD_SYNC
97	USB_PWR_SEL	98	HD_SIN
99	GND	100	GND
101	USB_1P	102	USB3_RX1n
103	USB_1N	104	USB3_RX1p
105	USB_OP	106	GND
107	USB_ON	108	USB3_TX1n
109	USB_OC#	110	USB3_TX1p
111	PCIE_ECX_RX3p	112	GND
113	PCIE_ECX_RX3n	114	SATA_TXn
115	PCIE_ECX_TX3n	116	SATA_TXp
117	PCIE_ECX_TX3p	118	Reserved
119	GND	120	GND
121	BID	122	GND
123	SMB_CLK_RESUME	124	DFI Board ID_0
125	SMB_DATA_RESUME	126	DFI Board ID_1
127	INT_GPIO#	128	DFI Board ID_2
129	PCIe_Wake#	130	SATA_RXn
131	INT_SERIRQ	132	SATA_RXp
133	VIN	134	VIN
135	+3.3VDU	136	+5VDU
137	+3.3VDU	138	+5VDU
139	GND	140	GND
141	+12V	142	+3.3V
143	+12V	144	+3.3V
145	+12V	146	+3.3V
147	+12V	148	+3.3V
149	GND	150	GND
151	+5V	152	+5V
153	+5V	154	+5V
155	+5V	156	+5V
157	+5V	158	+5V
159	+5V	160	+5V

## 12V DC-out

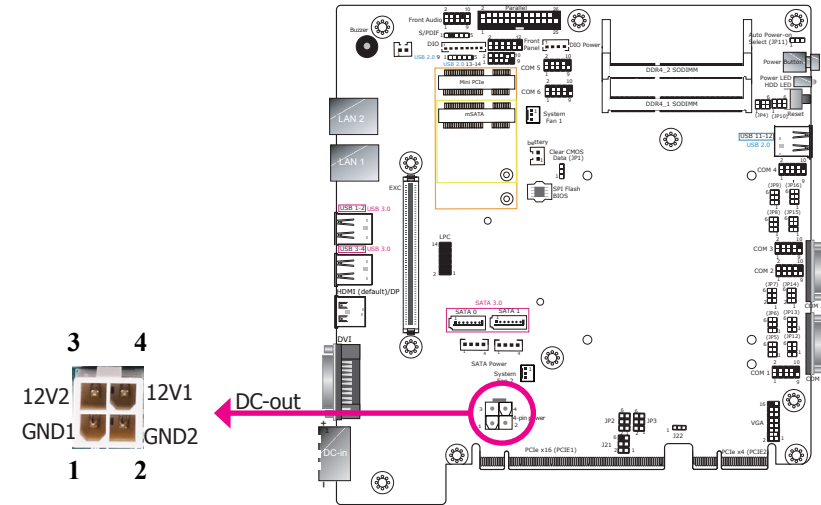

The 4-pin vertical type connector (optional) provides low power output.



## Chapter 6 - Mounting Options

### Wall Mount

The wall mount kit includes the following:

- 2 Wall mount brackets
- 4 Bracket screws



1. The wall mounting holes are located on the bottom of the system unit.

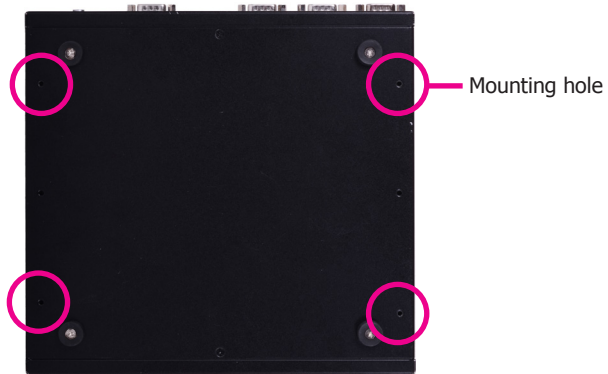

2. Use the provided mounting screws to secure the wall mount brackets on each side of the system unit.

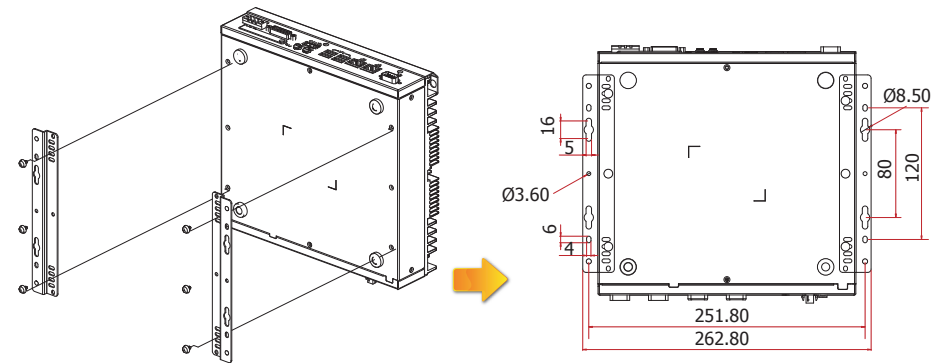
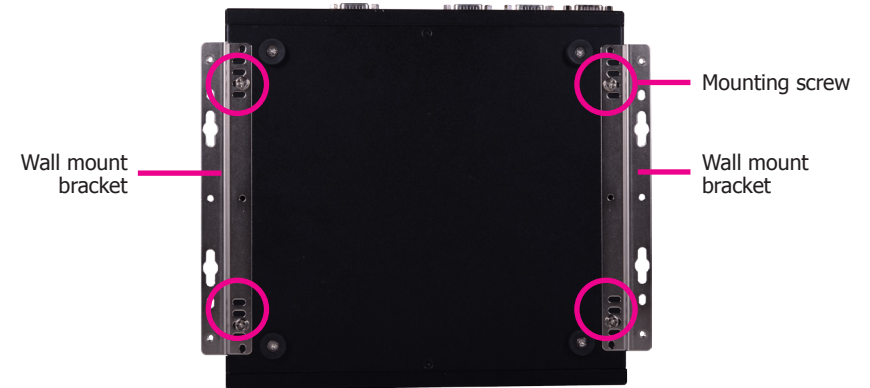

## Chapter 7 - BIOS Setup

### Overview

The BIOS is a program that takes care of the basic level of communication between the CPU and peripherals. It contains codes for various advanced features found in this system board. The BIOS allows you to configure the system and save the configuration in a battery-backed CMOS so that the data retains even when the power is off. In general, the information stored in the CMOS RAM of the EEPROM will stay unchanged unless a configuration change has been made such as a hard drive replaced or a device added. It is possible that the CMOS battery will fail causing CMOS data loss. If this happens, you need to install a new CMOS battery and reconfigure the BIOS settings.

**Note:**

The BIOS is constantly updated to improve the performance of the system board; therefore the BIOS screens in this chapter may not appear the same as the actual one. These screens are for reference purpose only.

### Default Configuration

Most of the configuration settings are either predefined according to the Load Optimal Defaults settings which are stored in the BIOS or are automatically detected and configured without requiring any actions. There are a few settings that you may need to change depending on your system configuration.

### Entering the BIOS Setup Utility

The BIOS Setup Utility can only be operated from the keyboard and all commands are keyboard commands. The commands are available at the right side of each setup screen.

The BIOS Setup Utility does not require an operating system to run. After you power up the system, the BIOS message appears on the screen and the memory count begins. After the memory test, the message "Press DEL to run setup" will appear on the screen. If the message disappears before you respond, restart the system or press the "Reset" button. You may also restart the system by pressing the <Ctrl> <Alt> and <Del> keys simultaneously.

### Legends

KEYs	Function
Right and Left Arrows	Moves the highlight left or right to select a menu.
Up and Down Arrows	Moves the highlight up or down between submenus or fields.
<Esc>	Exits to the BIOS setup utility
<F1>	Displays general help
<F5/F6>	Changes the highlighted value
<F9>	Changes to the default setup
<F10>	Saves and exits the setup program.
<Enter>	Press <Enter> to enter the highlighted submenu

### Scroll Bar

When a scroll bar appears to the right of the setup screen, it indicates that there are more available fields not shown on the screen. Use the up and down arrow keys to scroll through all the available fields.

### Submenu

When "►" appears on the left of a particular field, it indicates that a submenu which contains additional options are available for that field. To display the submenu, move the highlight to that field and press <Enter>.

## Insyde BIOS Setup Utility

### Main

The Main menu is the first screen that you will see when you enter the BIOS Setup Utility.

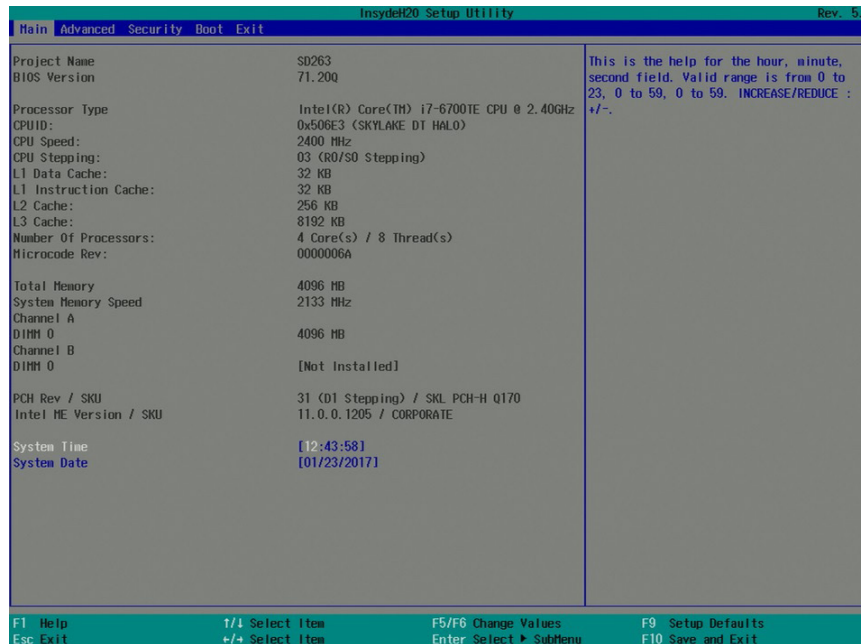

#### System Date

The date format is <month>, <date>, <year>. Month displays the month, from January to December. Date displays the date, from 1 to 31. Year displays the year, from 1980 to 2099.

#### System Time

The time format is <hour>, <minute>, <second>. The time is based on the 24-hour military-time clock. For example, 1 p.m. is 13:00:00. Hour displays hours from 00 to 23. Minute displays minutes from 00 to 59. Second displays seconds from 00 to 59.

### Advanced

The Advanced menu allows you to configure your system for basic operation. Some entries are defaults required by the system board, while others, if enabled, will improve the performance of your system or let you set some features according to your preference.



#### Important:

Setting incorrect field values may cause the system to malfunction.

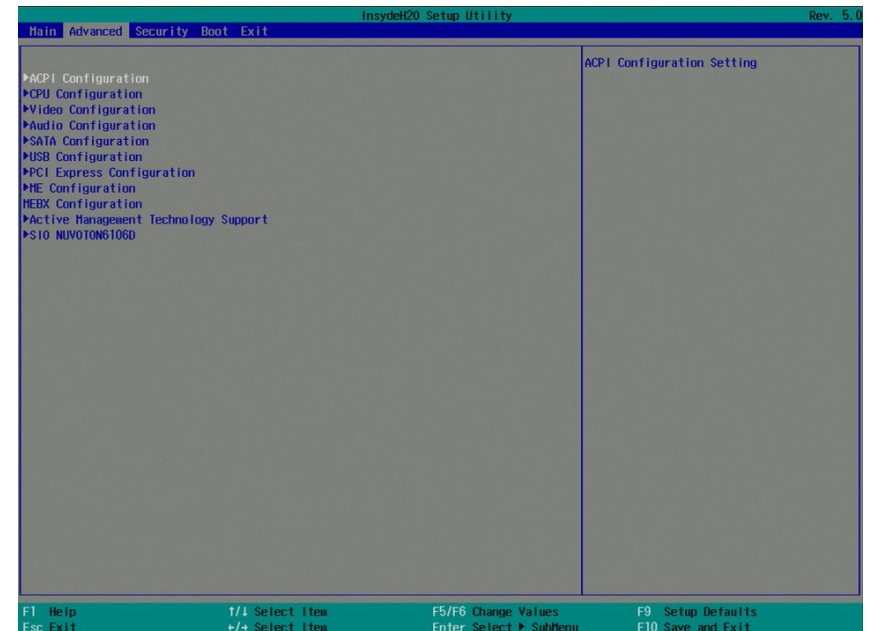

## ACPI Settings

This section configures the ACPI settings.

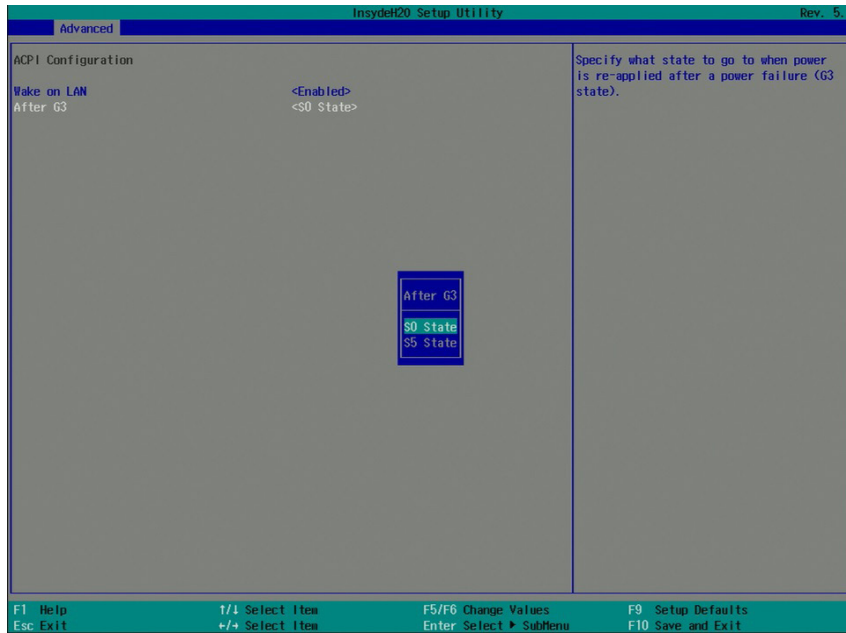

### Wake on LAN

Enable the system to be waken up via the onboard LAN.

### State After G3

Specify which state the system should be in when the power is re-applied after a power failure (G3 state, the mechanical-off state).

**S0 State** Power on the system when power is re-applied after AC power loss.

**S5 State** The system appears to be off when power is re-applied after AC power loss.

## CPU Configuration

This section configures the CPU.

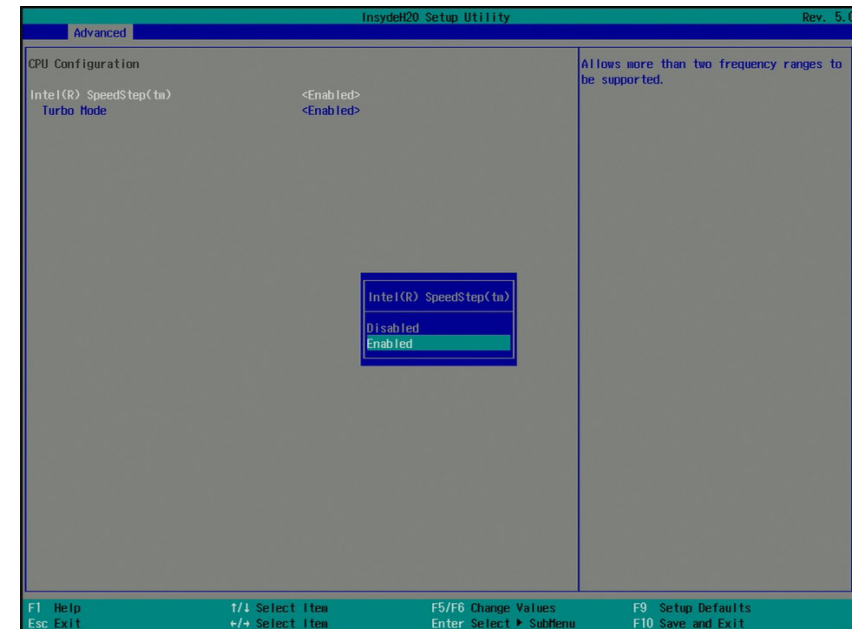

### Intel® SpeedStep™

Enable or disable the Enhanced Intel SpeedStep® Technology, which helps optimize the balance between system's power consumption and performance.

### Turbo Mode

Enable or disable processor turbo mode (requires that EMTTM is enabled too), which allows the processor core to automatically run faster than the base frequency when the processor's power, temperature, and specification are within the limits of TDP.

Note that the turbo mode is only available for the Intel® Core™ i7 and i5 processors.

## Video Configuration

This section configures the video settings. Note that the options may vary according to the "Boot type" selected in the "Boot" menu.

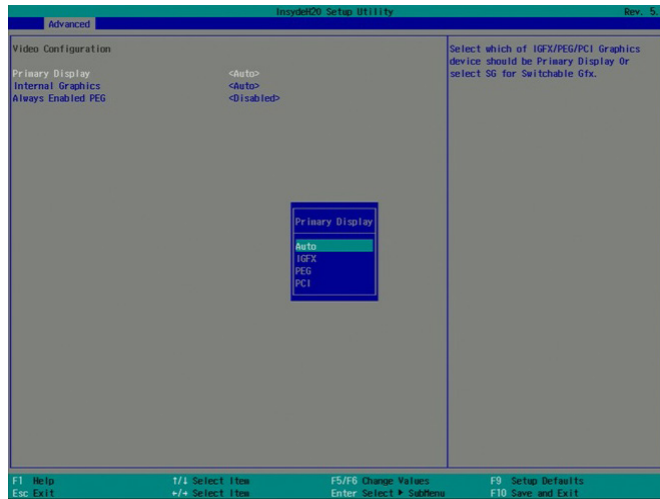

### Primary Display

Select the primary internal graphics.

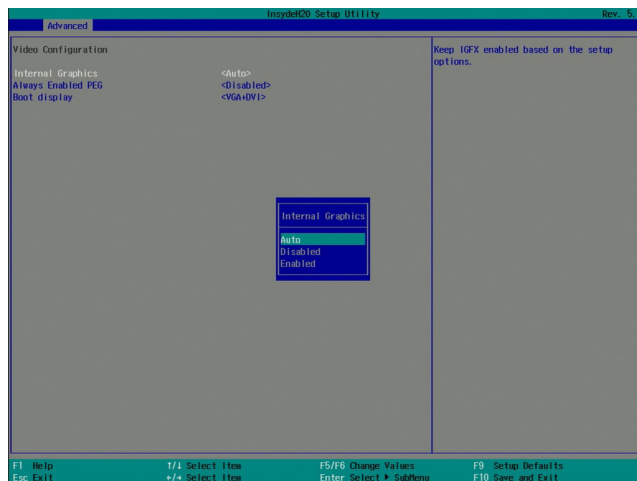

### Internal Graphics

Enable, disable or to automatically detect internal graphics.

### Always Enabled PEG

Enable or disable the PCIe graphics function.

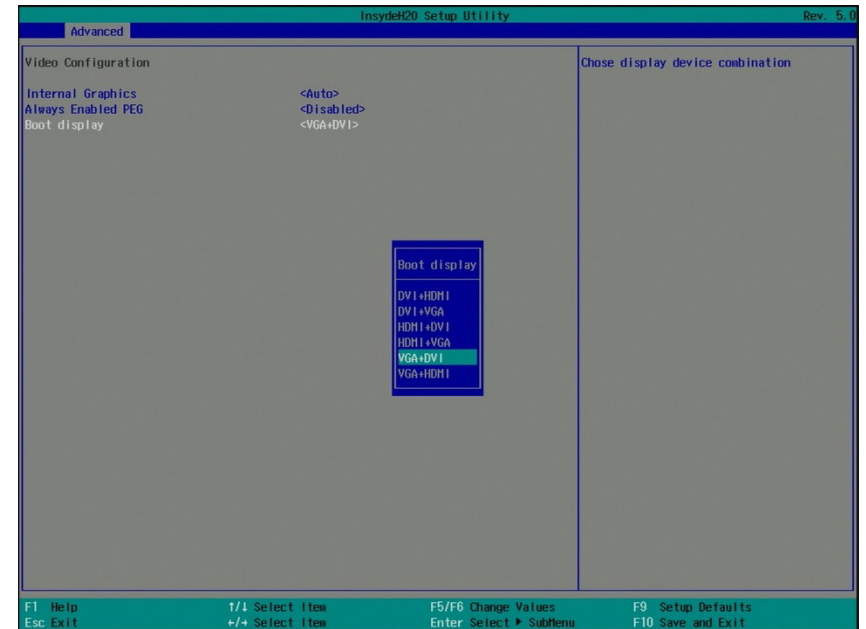

### Boot display

Set the display device combination during system booting. Note that this option only appears when the boot type selected is dual and legacy boot type.

## Audio Configuration

This section configures the audio settings.

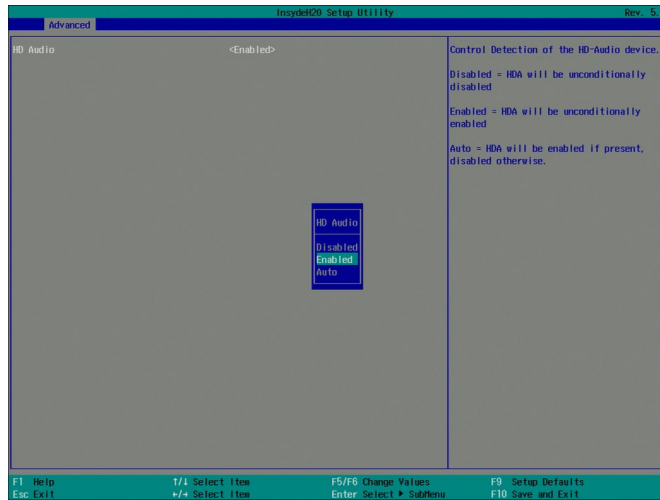

### HD Audio

Control the detection of high-definition audio devices.

#### Disabled

The high-definition audio will be unconditionally disabled.

#### Enabled

The high-definition audio will be unconditionally enabled.

#### Auto

The high-definition audio will be enabled if present and disabled otherwise.

## SATA Configuration

This section configures the SATA controller.

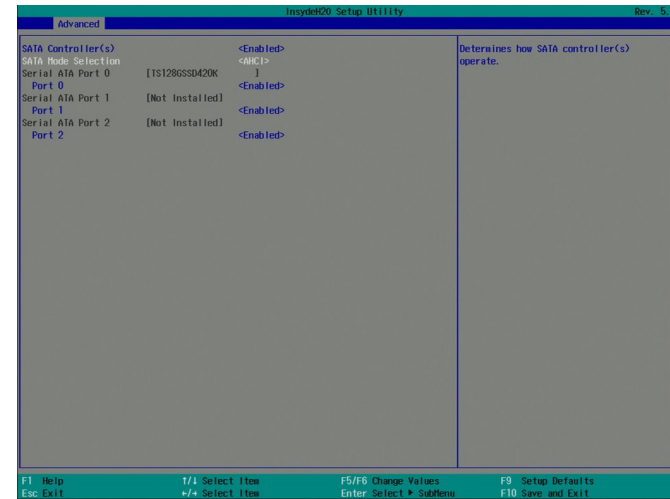

### SATA Controller(s)

This field is used to enable or disable Serial ATA devices.

### SATA Mode Selection

The mode selection configures the SATA controller(s).

#### AHCI Mode

This option allows the Serial ATA devices to use AHCI (Advanced Host Controller Interface).

#### RAID Mode

This option allows you to create RAID using Intel® Rapid Storage Technology (Intel® RST) on the Serial ATA devices.

### Serial ATA Port 0, 1 and 2

Enable or disable each serial ATA port:

SATA Port 0 controls SATA3\_0

SATA Port 1 controls SATA3\_1

SATA Port 2 controls the half-size Mini PCIe slot

## USB Configuration

This section configures the parameters of the USB devices.

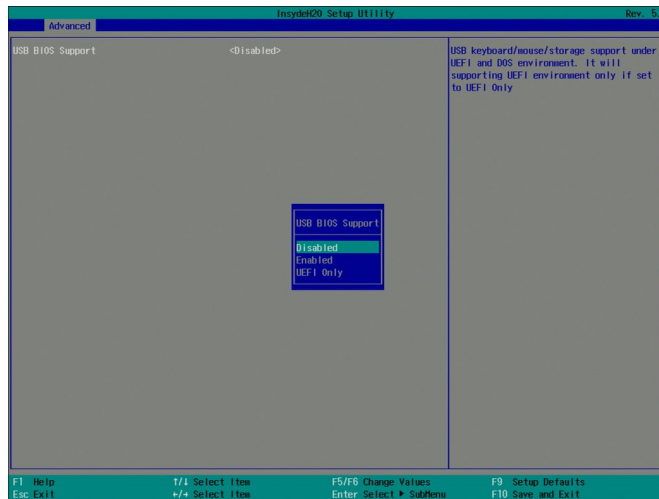

### USB BIOS Support

#### Disabled

Disable the USB keyboard/mouse/storage support.

#### Enabled

Enable the USB keyboard/mouse/storage support.

#### UEFI Only

Enable the USB keyboard/mouse/storage support only under the UEFI environment.

## PCI Express Configuration

This section configures the settings of PCI Express root ports.



PCIe root port 號碼跟 EC53x 的不大依樣

### PCI Express Root Port

Enable or disable each PCI Express Root Port:

PCIe Root Port 6 controls PCIE1 (x16) connector

PCIe Root Port 7 controls LAN 1

PCIe Root Port 8 controls LAN 2

PCIe Root Port 9 controls the full-size Mini PCIe slot

PCIe Root Port 10 controls PCIE2 (x4) connector

### PCIe Speed

Select the speed of the PCI Express Root Port: Auto, Gen1, Gen2 or Gen3.

## ME Configuration

This section configures flashing of Intel® Active Management Engine region.

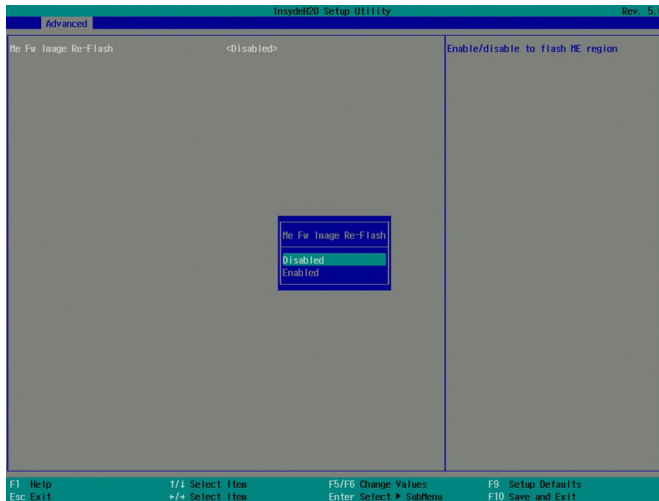

### Me Fw Image Re-Flash

Enable or disable flashing of the Intel® ME region.

## Active Management Technology Support

The section allows users to enable or disable the Intel® Active Management Technology (Intel® AMT) BIOS extension. Please refer to Chapter 10 - Intel AMT Settings for more information. Note that the Intel® AMT is only available for the Intel® Core™ i7 and i5 processors.

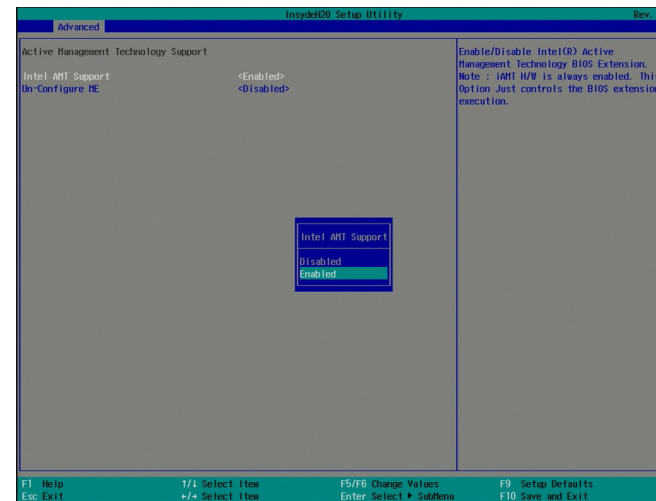

### Intel AMT Support

Enable or disable Intel® Active Management Technology BIOS extension.

### Un-Configure ME

Clears all ME related configurations without requiring a password on the next boot.



## Super IO

This section configures the system's super I/O chip parameters.

### Smart Fan Function

This section configures the Smart Fan Function.

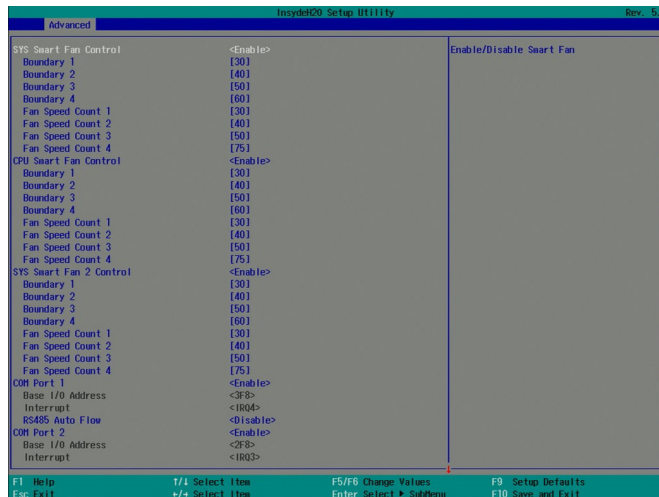

### SYS Smart Fan/CPU Smart Fan/SYS Smart Fan2 Control

Enable or disable the smart fan.

#### Boundary 1 to Boundary 4

Set the boundary temperatures that determine the operation of the fan with different fan speeds accordingly. For example, when the system or the CPU temperature reaches boundary temperature 1, the system or CPU fan should be turned on and operate at the designated speed.

The range of the temperature is from 0 to 127°C.

#### Fan Speed Count 1 to Fan Speed Count 4

Set the fan speed. The range is from 0 (fan stop)-100% (full speed).

## COM Port Configuration

This section configures serial port settings.

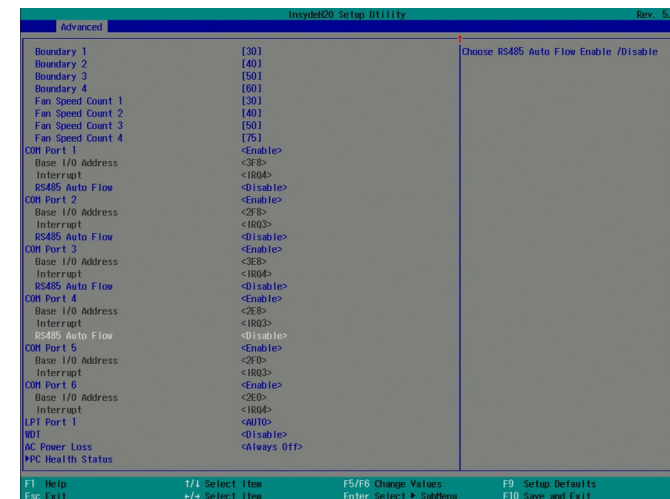

### COM Port 1 to COM Port 4

Configure the settings of the serial ports.

**Disable** Disable the serial port.

**Enable** Enable the serial port.

RS485 Auto Flow

**Disable** Disable the RS485 auto flow mechanism.

**Enable** Enable the RS485 auto flow mechanism.

### COM Port 5 and COM Port 6

**Disable** Disable the serial port.

**Enable** Enable the serial port.

## LPT Port 1

Enable, disable or automatically detect the parallel port on the board.

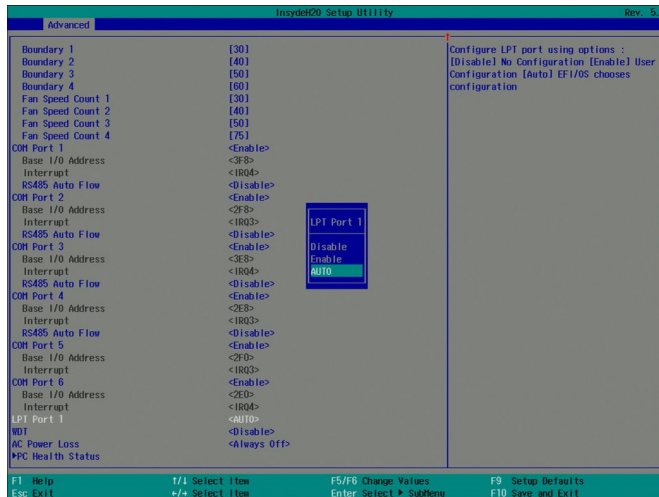

## WDT

Enable or disable the watchdog function.

## AC Power Loss

Set the AC power loss to Always off or Always on. When it is set to Always off, the system's status will be power-off after an AC power loss event. When it is set to Always on, the system's status will be power-on after an AC power loss event.

## PC Health Status

This screen displays PC health information.

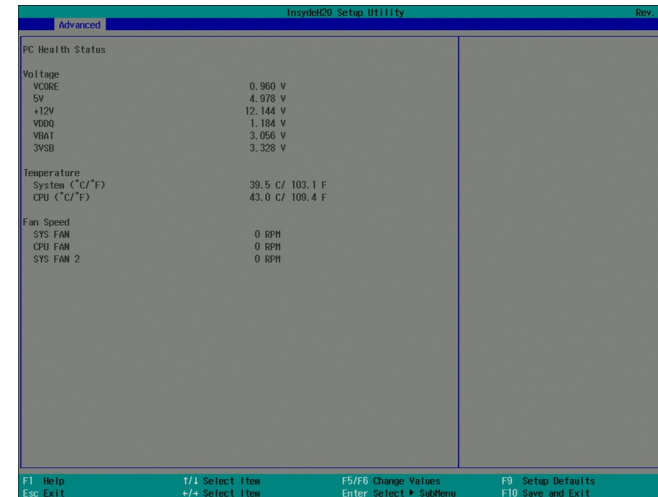

## Security

This section configures the trusted platform module (TPM) and storage security.

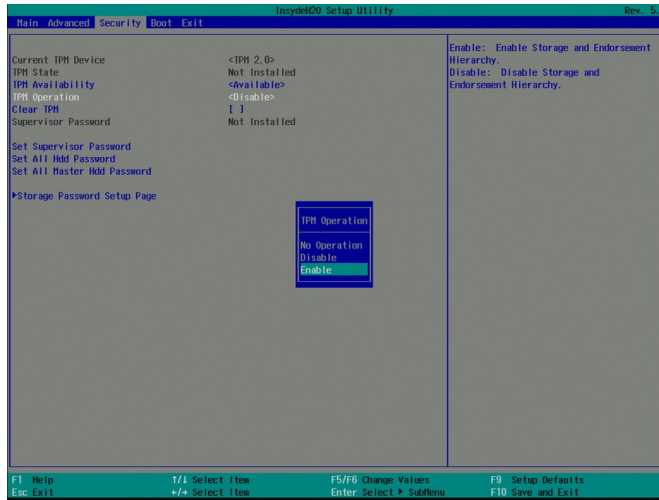

### TPM Availability

Show or hide the TPM availability and its configurations.

### TPM Operation

Enable or disable the TPM function. It displays the following options:

- No Operation: No changes to the current state.
- Disable: Disable and deactivate TPM.
- Enable: Enable and activate TPM.

### Clear TPM

Remove all TPM ownership contents.

### Set Supervisor Password

Set the administrative password. The length of the password must be greater than one character and less than or equal to 10 characters. Depending on the state of power-on password selected, the supervisor password may be required upon POST or when entering the BIOS setup utility.

### Power on Password

Select "enabled" to require users to input the supervisor password when the system is entering the POST (power-on self-test).

### Set All HDD Password

Set password for all HDDs. The length of the password must be greater than one character and less than or equal to 32 characters.

### Set All Master HDD Password

Set the master password for all HDDs. The length of the password must be greater than one character and less than or equal to 32 characters.

To set password for each storage device, use the "Storage Password Setup Page" option.

## Storage Password Setup Page

Enhance the HDD security for each HDD device by using a password.

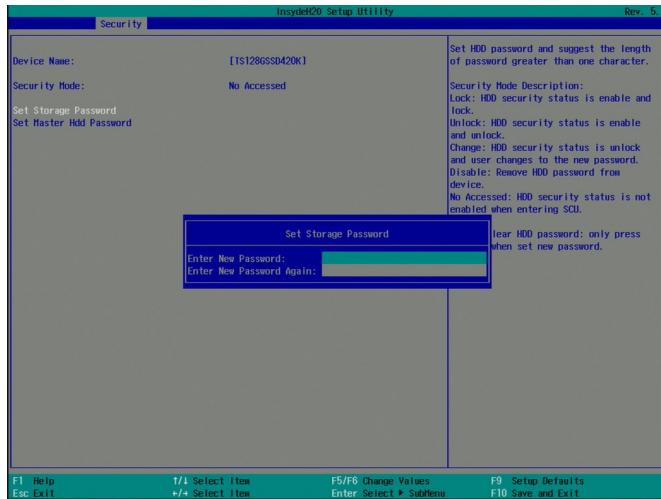

### Set Storage Password

Set all HDD password. The length of the password must be greater than one character and less than or equal to 32 characters.

### Set Master HDD Password

Set the master password for all HDDs. The length of the password must be greater than one character and less than or equal to 32 characters. When the security mode is set to Lock, input the master HDD password to unlock the HDD. Clear the HDD password by pressing "Enter" to set HDD security to be disabled and set a new master HDD password.

## Boot

This section configures boot options.

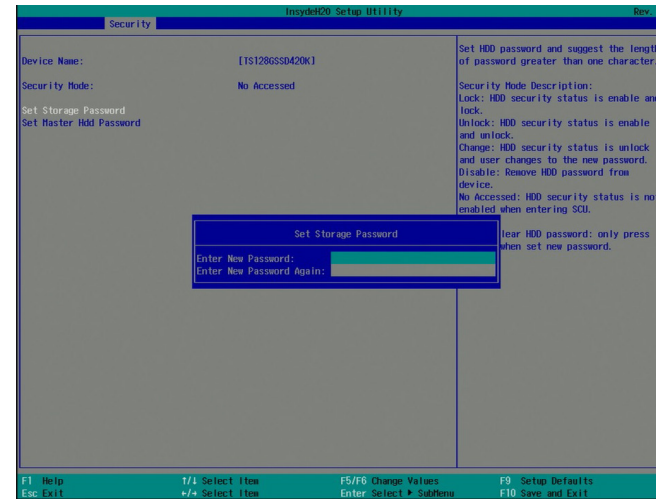

### Numlock

Select the power-on state for numlock.

### Boot Type

Select the boot type. The options include Dual Boot Type, Legacy Boot Type, and UEFI Boot Type.

### Network stack

Enable or disable UEFI network stack. This option is only available if the boot type is set to be UEFI or Dual. It supports the operation of these functions or software: Windows 8 BitLocker Network Unlock, UEFI IPv4/IPv6 PXE and legacy PXE Option ROM.

### PXE Boot Capability

Enable or disable PXE (Preboot eXecution Environment).

### USB Boot

Enable or disable booting to USB boot devices.



#### Note:

If the boot type is set to UEFI, the method for RAID volume creation will be different. Please refer to Chapter 9 – RAID for more information.

## Legacy

This section configures legacy boot order.

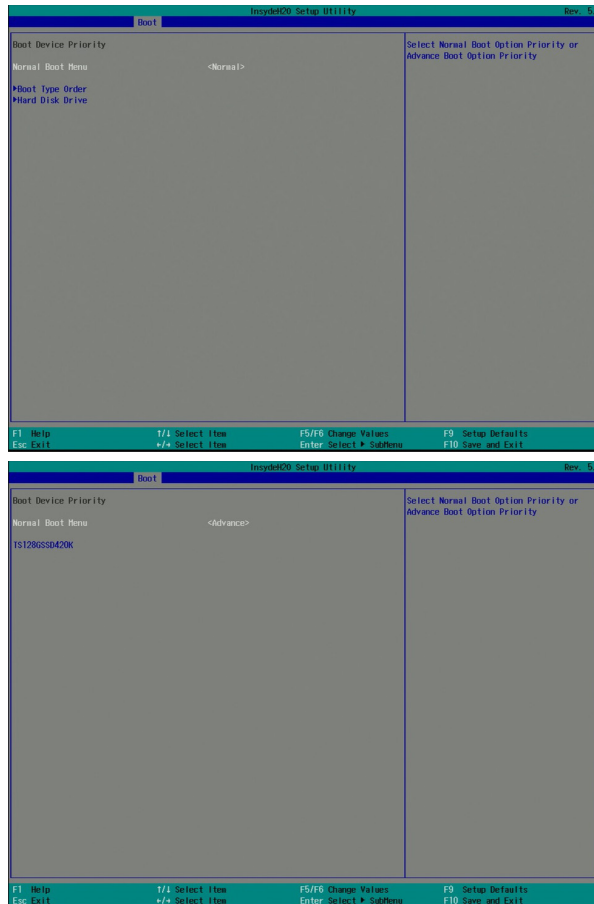

## Normal/Advanced Boot Menu

### Normal

Select the boot menu type: normal or advanced.

For the advanced menu type: Use + and - keys to arrange the priority of the detected boot devices.

For normal menu type: Select the "Boot Type Order" or "Hard Disk Drive" or "USB" category to view and arrange the order of the listed devices.

## Boot Type Order

Use + and - keys to arrange the sequence of storage devices that the system's hardware will check in the operating system's boot files. The first device in the order list has the highest boot priority.



## Hard Disk Drive

All installed hard disk drives will be displayed in this screen. Use + and - keys to arrange the sequence of hard disk drives that the system's hardware will check in the operating system's boot files.

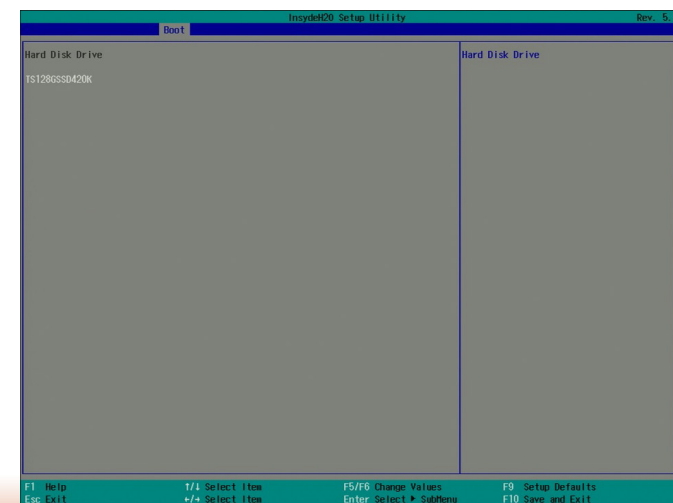

## Exit

This section configures the parameters for exiting the BIOS menu.

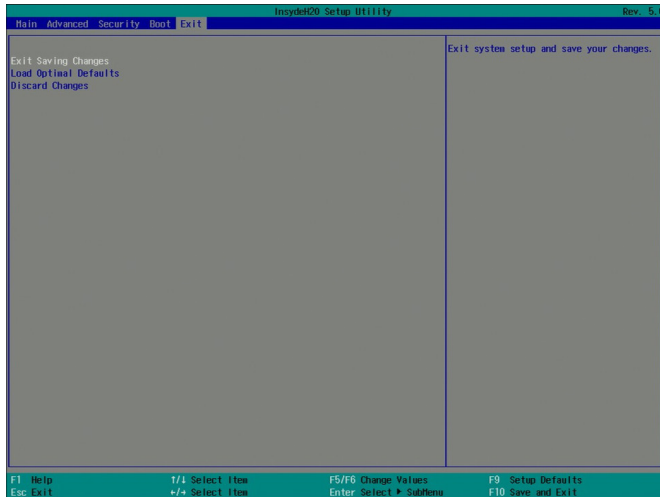

### Exit Saving Changes

Select this field and then press <Enter> to exit the BIOS setup and save your changes.

### Load Optimal Defaults

Select this field and then press <Enter> to load optimal defaults.

### Discard Changes

Select this field and then press <Enter> to exit the BIOS setup without saving your changes.

## Updating the BIOS

To update the BIOS, you will need the new BIOS file and a flash utility. Please contact technical support or your sales representative for the files and specific instructions on how to update BIOS with the flash utility.

When you download the given BIOS file, you may find a BIOS flash utility attached with the BIOS file. This is the utility for performing BIOS updating procedure. For your convenience, we will also provide you with an auto-execution file in the downloaded BIOS file. This auto-execution file will bring you directly to the flash utility menu soon after system boots up and finishes running the boot files in your boot disk.

```

Read file successfully. (path= "platform.ini")

Information
Please do not remove the AC power

Insyde H20FFT (Flash Firmware Tool) Version (SEG) 100.00.08.10
Copyright(c) 2012 - 2016, Insyde Software Corp. All Rights Reserved.

Initializing
Current BIOS Model name: SD263
New BIOS Model name: SD263

Current BIOS version: 65.05A
New BIOS version: 65.05A

Updating Block at FFFFF000h
0%      25%      50%      75%      100%
|-----|-----|-----|-----|
C:\SD263>_

```

## Notice: BIOS SPI ROM

1. The Intel® Management Engine has already been integrated into the system board. Due to safety concerns, the BIOS (SPI ROM) chip cannot be removed from this system board and used on another system board of the same model.
2. The BIOS (SPI ROM) on this system board must be the original equipment from the factory and cannot be used to replace one which has been utilized on other system boards.
3. If you do not follow the methods above, the Intel® Management Engine will not be updated and will cease to be effective.

### Note:



- a. You can take advantage of flash tools to update the default configuration of the BIOS (SPI ROM) to the latest version anytime.
- b. When the BIOS IC needs to be replaced, you have to populate it properly onto the system board after the EEPROM programmer has been burned and follow the technical person's instructions to confirm that the MAC address should be burned or not.

## Chapter 8 - Supported Software

Some devices of the system require drivers from hardware manufactures to operate properly. The system may come with a CD/DVD that contains drivers, utilities and software applications. Insert the CD into a CD-ROM drive. The auto-run screen (Mainboard Utility CD) will appear. If the "Autorun" does not automatically start, please go to the root directory of the CD and double-click "Setup".

If your product package does not include a CD/DVD, you can download the latest drivers from the DFI Download Center:

<http://www.dfi.com/DownloadCenter>

Once you are in the Download Center page, select your product or type the model name and click "Search" to find product-related resources such as documentation and drivers.

### For Windows 10

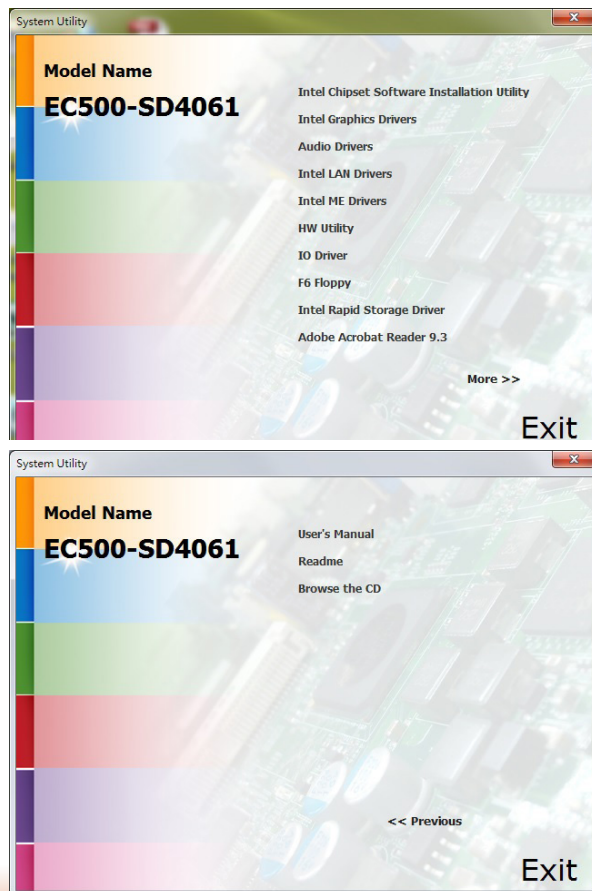

### For Windows 8.1

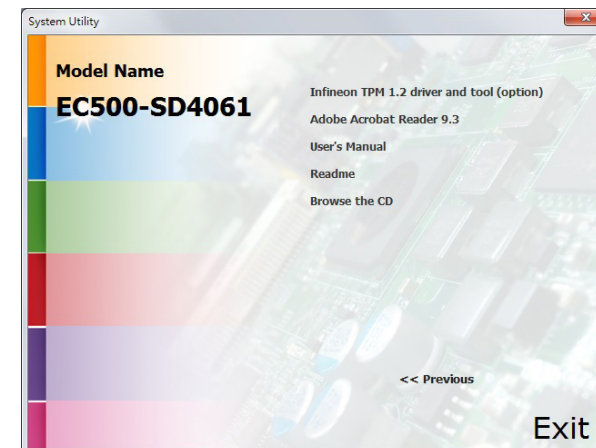



## For Windows 7

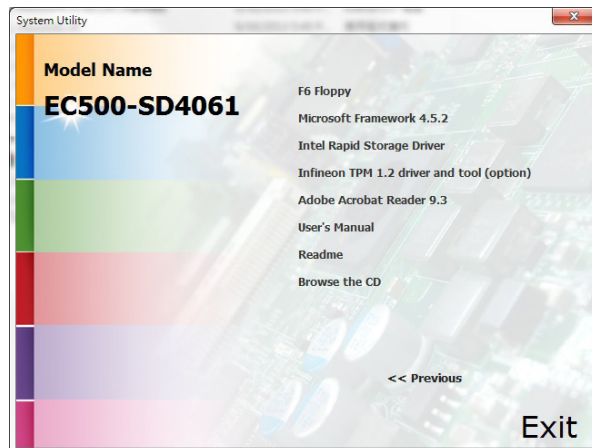
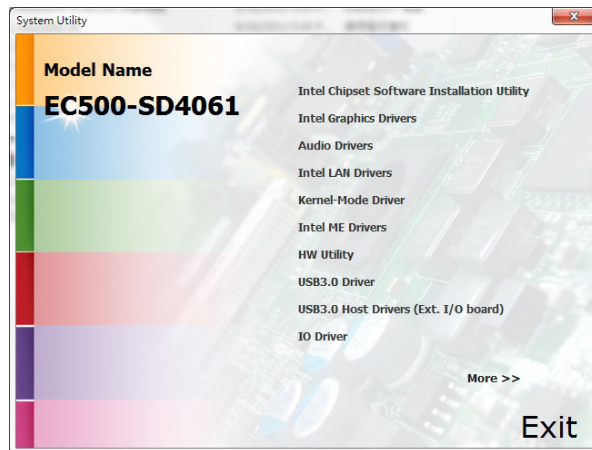

## Intel Chipset Software Installation Utility

The Intel Chipset Software Installation Utility is used for updating Windows® INF files so that the Intel chipset can be recognized and configured properly in the system.

To install the utility, click "Intel Chipset Software Installation Utility" on the main menu.

1. Setup is ready to install the utility. Click "Next" to continue.

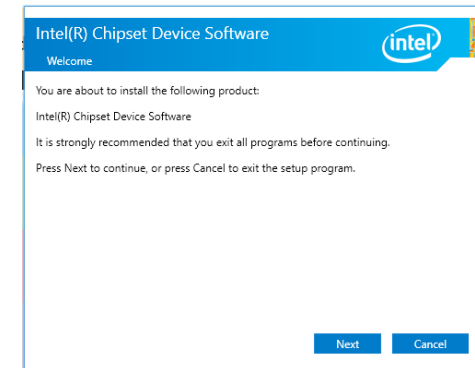

2. Read the license agreement and then click "Yes".

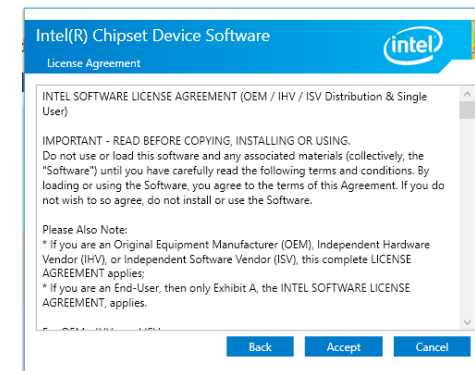

- Go through the readme document for more installation tips and then click "Next".

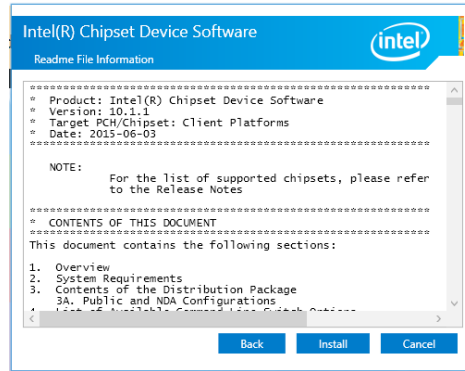

- Click "Finish" to exit setup.

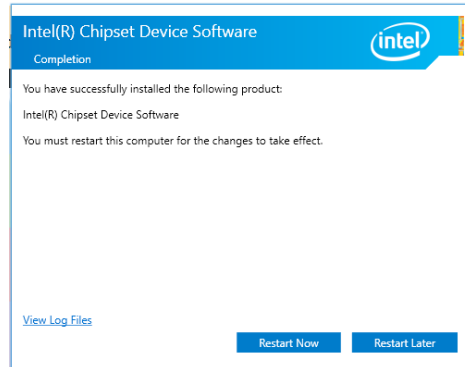

## Intel Graphics Drivers

To install the driver, click "Intel Graphics Drivers" on the main menu.

- Setup is now ready to install the graphics driver. Click "Next" to continue.

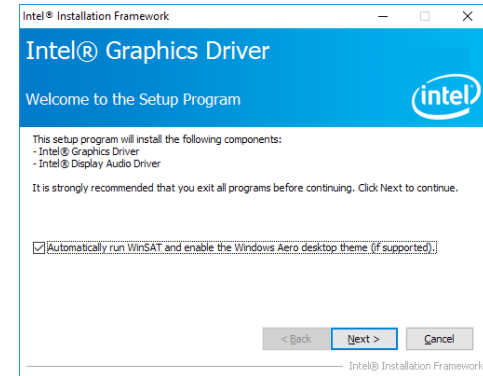

By default, the "Automatically run WinSAT and enable the Windows Aero desktop theme" is enabled. With this enabled, after the graphics driver is installed and the system is rebooted, the screen will turn blank for 1 to 2 minutes (while WinSAT is running) before the Windows 7/Windows 8.1/Windows 10 desktop appears. The "blank screen" period is the time Windows is testing the graphics performance.

- Read the license agreement and then click "Yes".

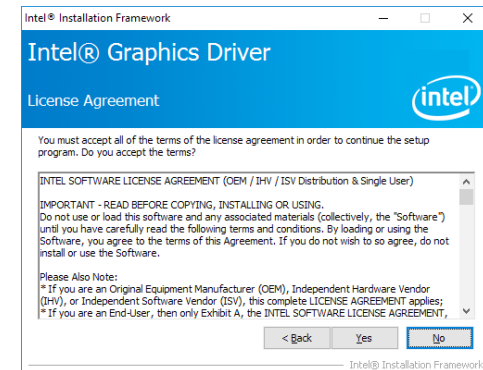

- Go through the readme document for system requirements and installation tips and then click "Next".

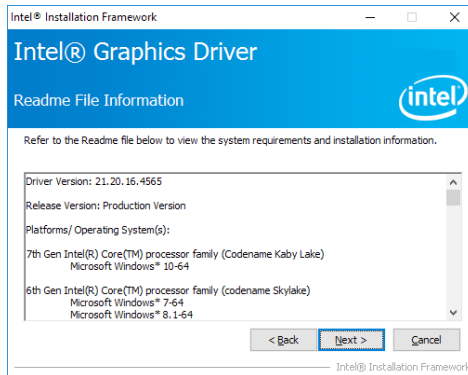

- Setup is now installing the driver. Click "Next" to continue.

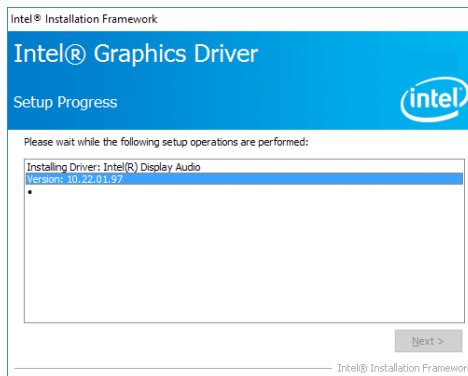

- Click "Yes, I want to restart this computer now" and then click "Finish".

Restarting the system will allow the new software installation to take effect.

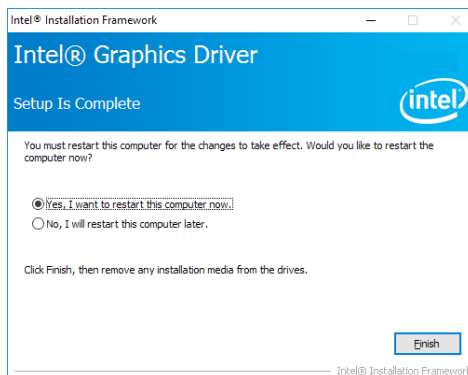

## Audio Drivers

To install the driver, click "Audio Drivers" on the main menu.

- Setup is ready to install the driver. Click "Next" to continue.

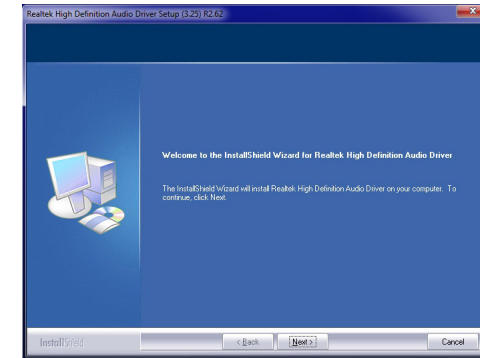

- Click "Yes, I want to restart my computer now" and then click "Finish".

Restarting the system will allow the new software installation to take effect.

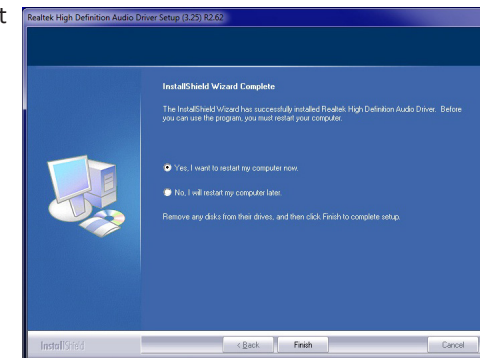

## Intel LAN Drivers

To install the driver, click "Intel LAN Drivers" on the main menu.

1. Setup is ready to install the driver. Click "Next" to continue.
2. Read and License Agreement and click "I accept the terms in the license agreement" if you agree the terms in the agreement, and then click "Next".
3. Select the program features you want to install and then click "Next".

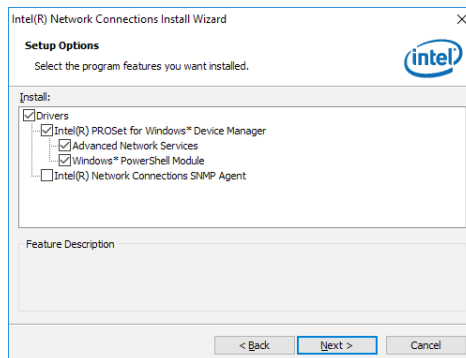
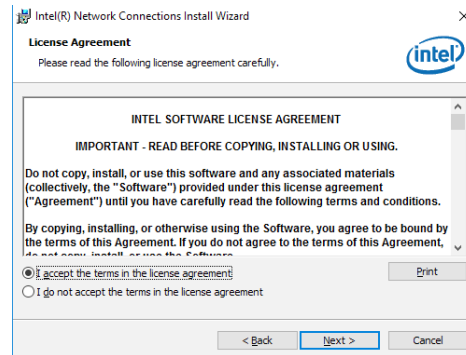
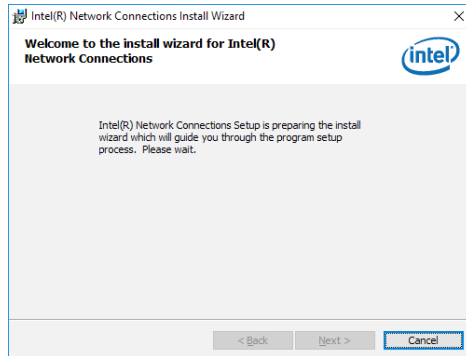

4. Click "Install" to begin the installation.

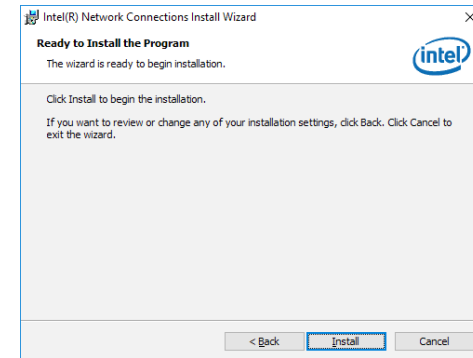

5. After the installation is complete, click "Finish" to exit setup.

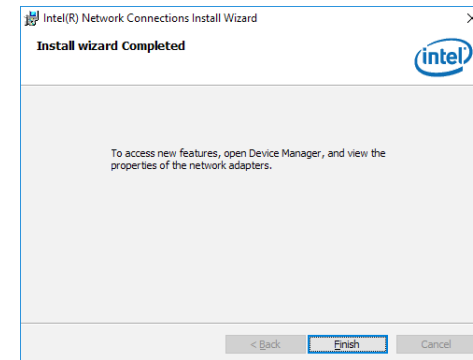

## Kernel Mode Driver (For Windows 7 only)

To install the driver, click "Kernel Mode Driver Framework" on the main menu.

1. Click "Yes" to install the update.

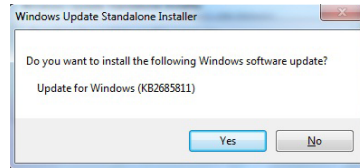

2. The update is being installed now.

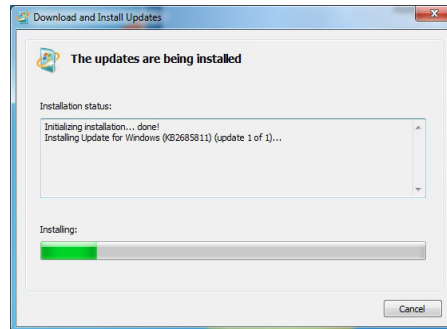

3. Click "Restart Now" to restart your computer when the installation is complete.

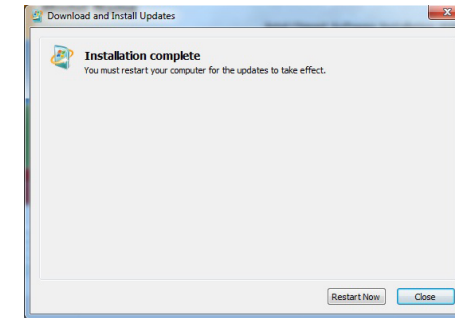

## Intel Management Engine Drivers

To install the driver, click "Intel Management Engine Drivers" on the main menu.

1. Setup is ready to install the driver. Click "Next" to continue.

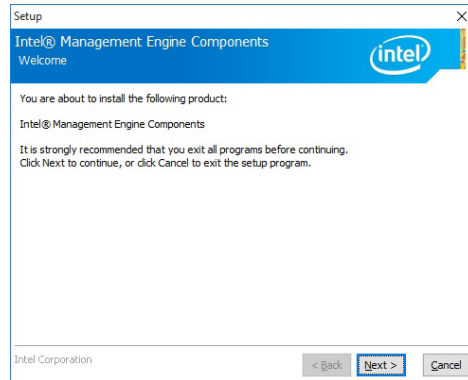

2. Read and License Agreement and click "I accept the terms in the license agreement" if you agree with the terms in the agreement, and then click "Next".

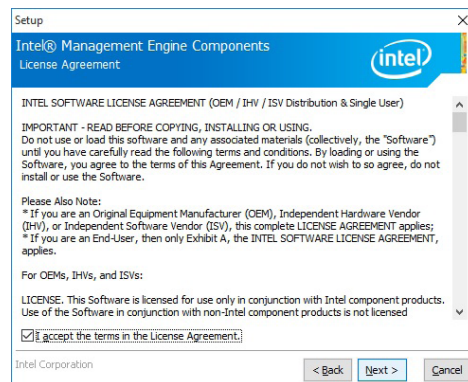

3. Setup is currently installing the driver. After the installation is complete, click "Next".

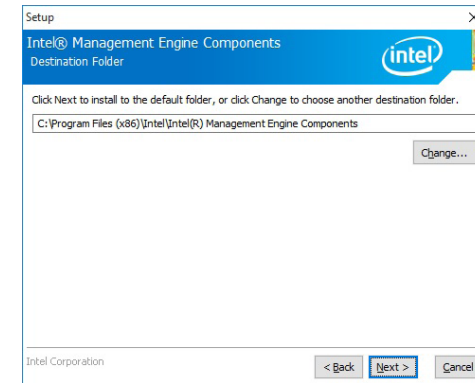

4. Please wait while the product is being installed.

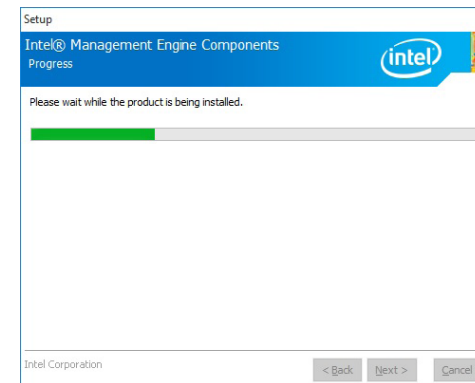

5. After the installation is complete, click "Finish" to exit setup.

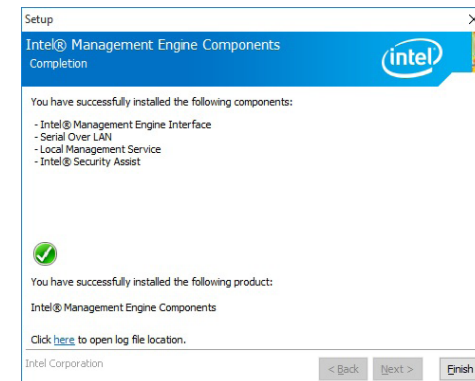

## HW Utility

HW Utility provides information about the board and enables you to configure Watchdog and DIO functions. To access the utility, click "HW Utility" on the main menu.



**Note:**

If you are using Windows 7 or later versions, you need to access the operating system as an administrator to be able to install the utility.

1. Setup is ready to install the driver.

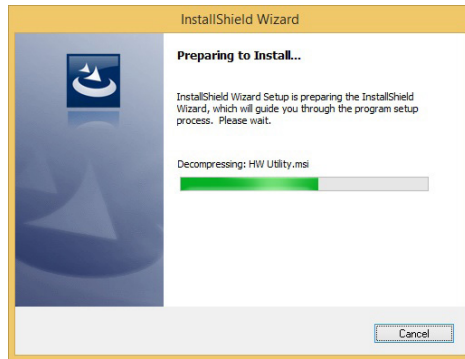

2. Click "Next" to continue.

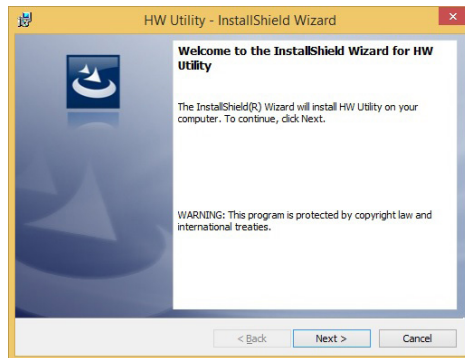

3. Read the license agreement and then click "I accept the terms in the agreement" if you accept the terms in the agreement. Click "Next" to continue.

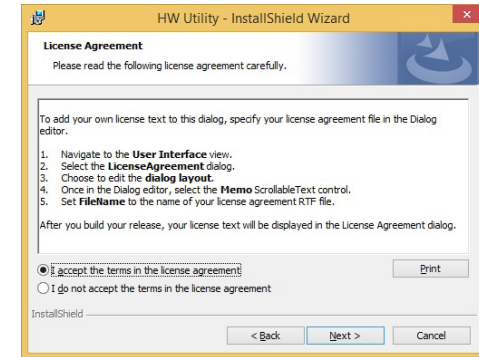

4. The wizard is ready to start the installation. Click "Install".

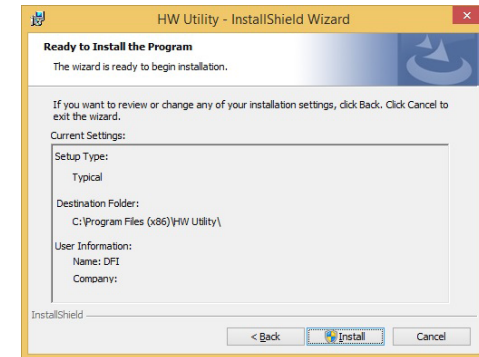

5. Please wait while the program features are being installed.

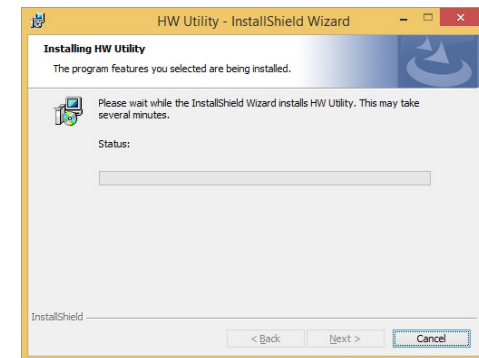

- After the installation is complete, click "Finish" to exit setup.

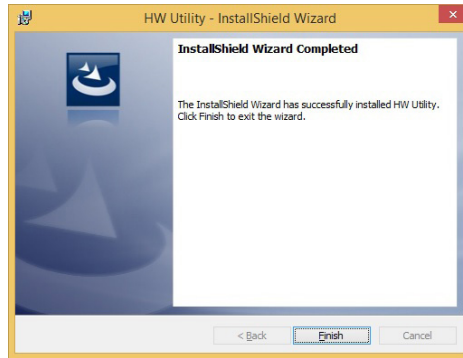

HW Health

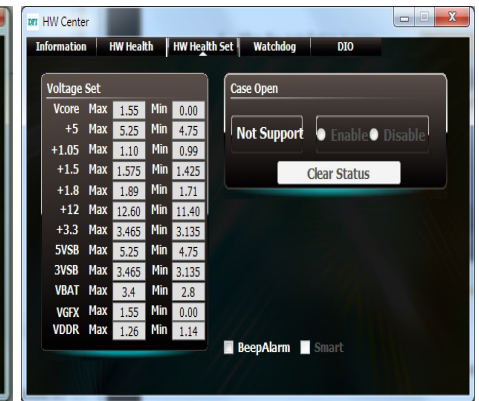

HW Health Set

The HW Utility icon will appear on the desktop. Double-click the icon to open the utility.

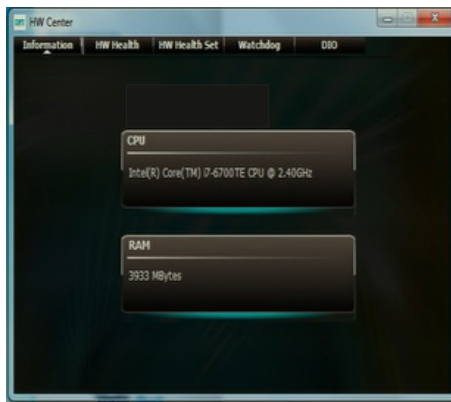

Watchdog



DIO



**Note:**

The screenshot displayed above is for illustrative purpose only, and may not resemble the actual screen.

The EC531/532-SD Utility features the following tabs: Information, HW Health, HW Healthset, Watchdog, and DIO. Click on the tabs to access each function.



## USB 3.0 Driver (For Windows 7 and Windows 8.1)

To install the driver, click "USB 3.0 Driver" and "USB 3.0 Host Drivers (Ext. I/O board) " on the main menu.

1. Setup is ready to install the driver. Click "Next" to continue.

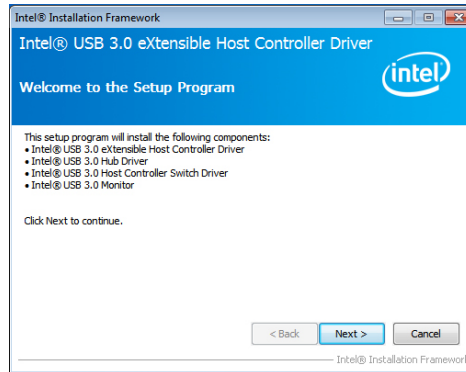

2. Read the license agreement and then click "Yes" if you agree with the terms in the agreement.

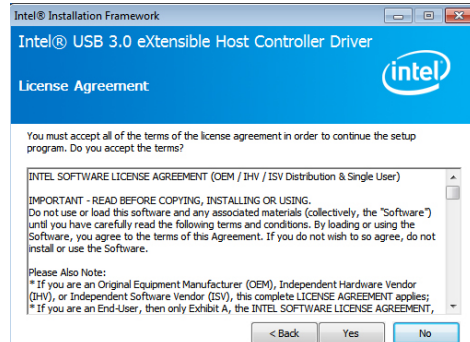

3. Go through the readme document for more installation tips and then click "Next".

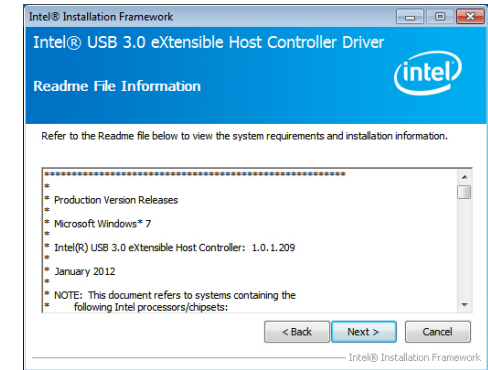

4. Setup is currently installing the driver. After the installation is complete, click "Next".

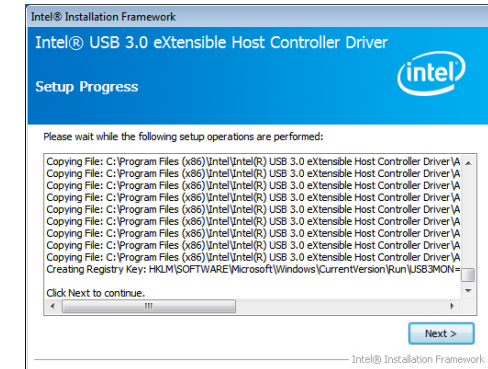

5. After the installation is complete, click "Finish".

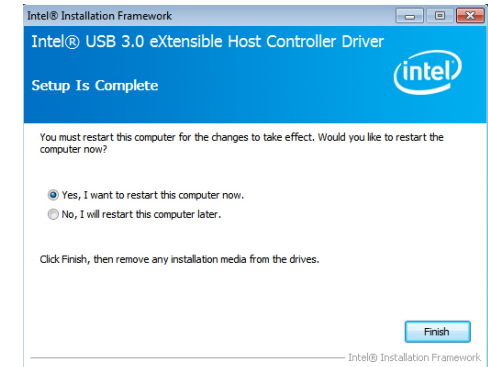

## IO Driver (For Windows 7-64 bit, 8.1 and 10)

To install the driver, click "IO Driver" on the main menu

1. Setup is ready to install the driver.  
Click "Next" to continue.

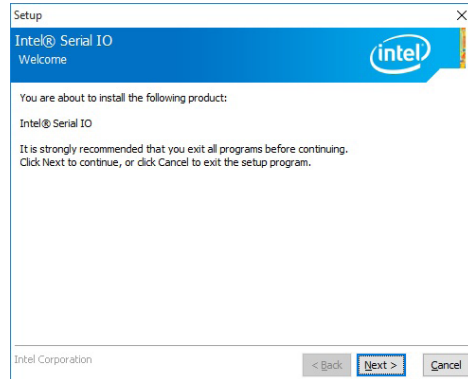

2. Read the license agreement carefully.  
Click "I accept the terms in the License Agreement" if you agree with the terms in the agreement and then click "Next".

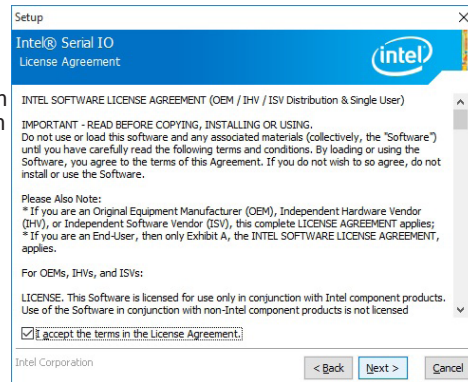

3. Read the file information and then click "Next".

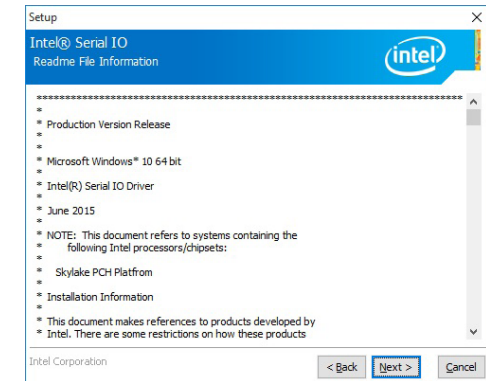

4. Setup is ready to install the driver.  
Click "Next" to begin the installation.

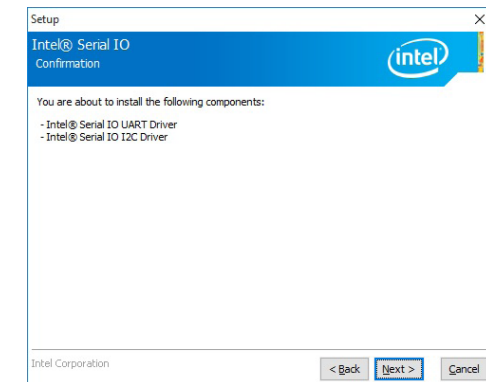

5. Setup is now installing the driver.

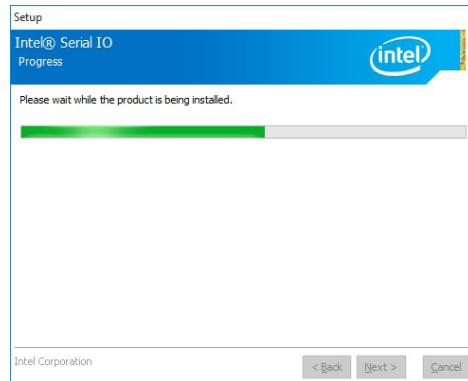

6. Click "Finish" to exit setup.

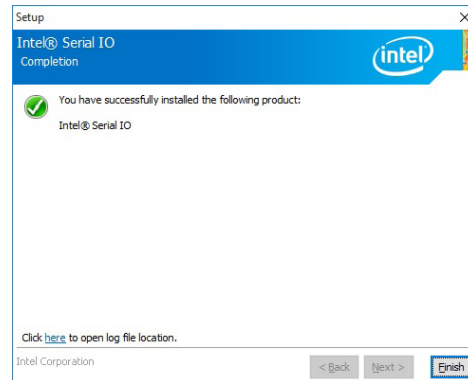

## Microsoft Framework 4.5.2 (For Windows 7)



### Note:

Before installing Microsoft Framework 4.5.2, make sure you have updated your Windows 7 operating system to Service Pack 3.

To install the driver, click "Microsoft Framework 4.5.2" on the main menu.

1. Setup is now extracting files.

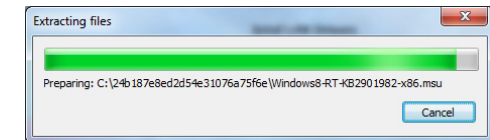

2. Read the license agreement carefully.

Click "I have read and accept the terms of the License Agreement" if you agree with the terms in the agreement and then click "Next".

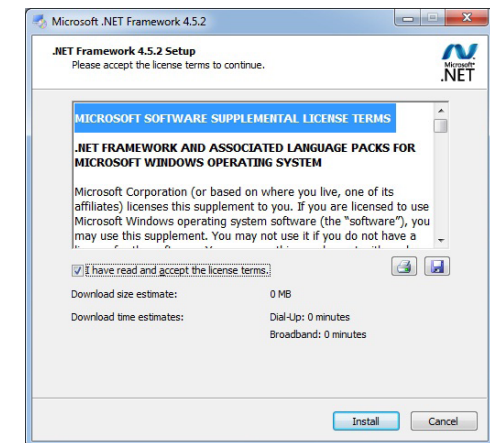

3. Setup is now installing the driver.

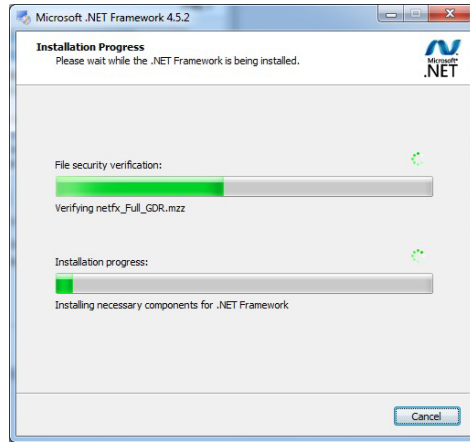

4. Click "Finish" to exit setup.

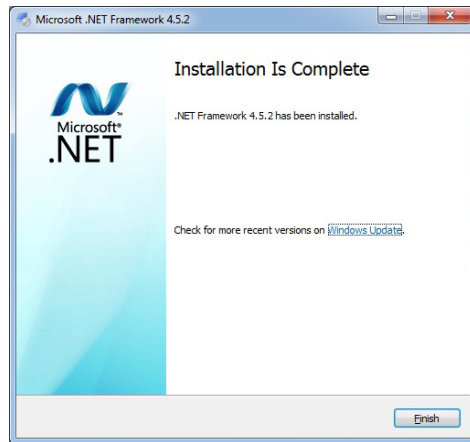

## Intel Rapid Storage Technology

The Intel Rapid Storage Technology is a utility that allows you to monitor the current status of the SATA drives. It also enables enhanced performance and power management for the storage subsystem.

To install the driver, click "Intel Rapid Storage Driver" on the main menu.

1. The setup program is preparing to install the driver. Please exit all programs before continuing with the installation.

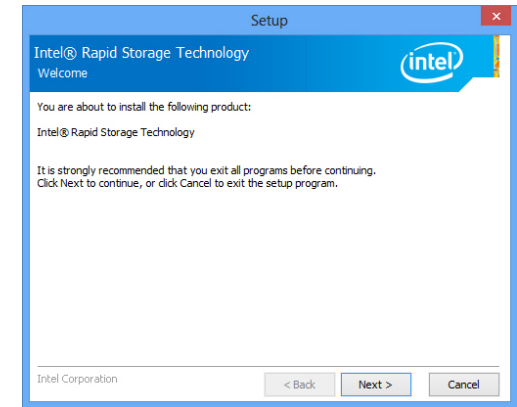

2. Read the license agreement carefully, accept the terms of the License Agreement, then click "Next" to continue.

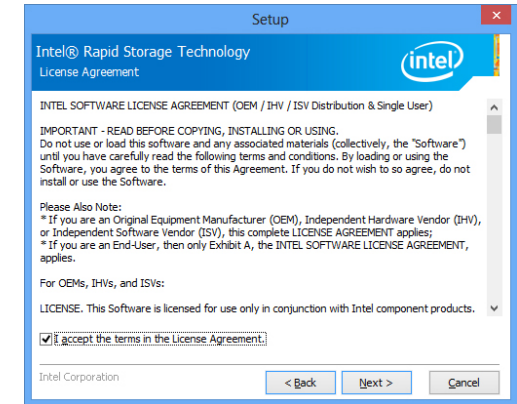

3. Read the readme information and then click "Next."

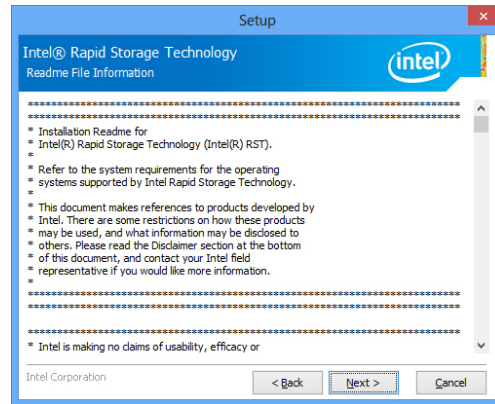

4. Setup is currently installing the driver. Click "Next" to install to the default folder or select to change the installation folder. The setup will then inform you that the Intel® Rapid Storage Technology will be installed on your system.

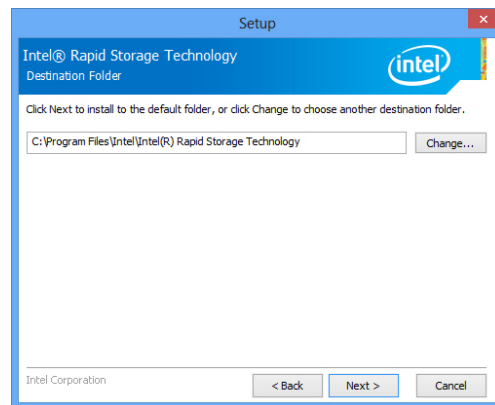

5. Click "Yes, I want to restart this computer now", then click "Finish."

Restarting the system will allow the new software installation to take effect.



## Infinion TPM Driver and Tool (optional)

To install the driver, click "Infinion TPM driver and tool (option)" on the main menu.

1. The setup program is preparing to install the driver.

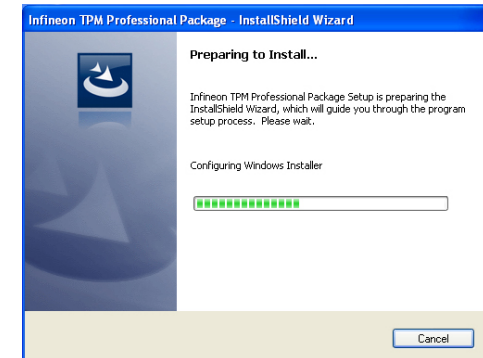

2. The setup program is now ready to install the utility. Click "Next" to continue.

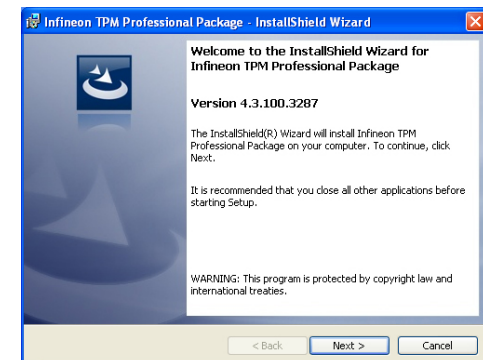

3. Click "I accept the terms in the license agreement" if agree with the terms in the agreement and then click "Next".

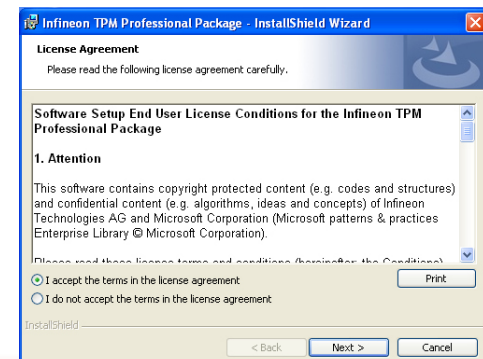

4. Enter the necessary information and then click "Next".

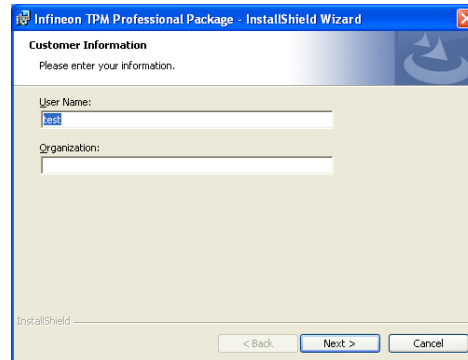

5. Select the setup type and then click "Next".

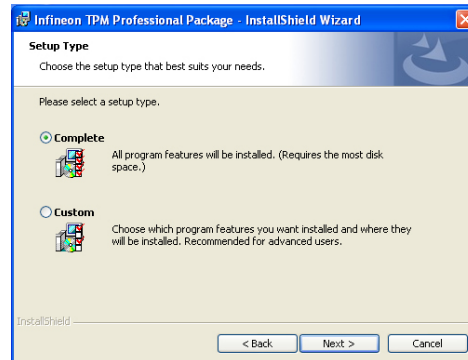

6. Click "Install" to start the installation.

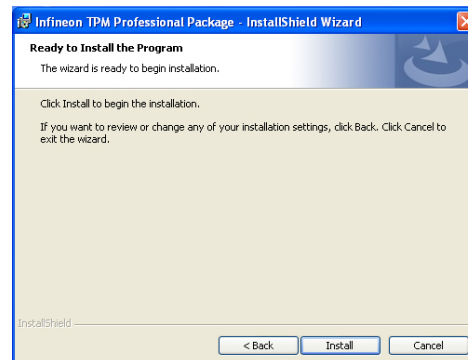

7. TPM requires installing the Microsoft Visual C++ package prior to installing the utility. Click "Install".

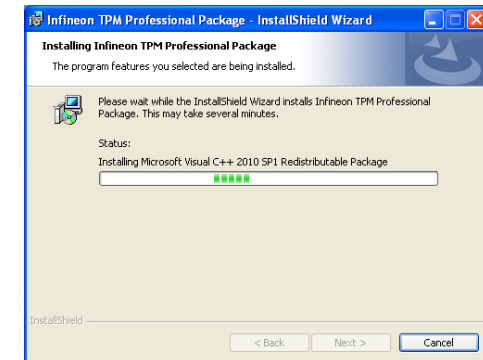

8. The setup program is currently installing the Microsoft Visual C++ package.

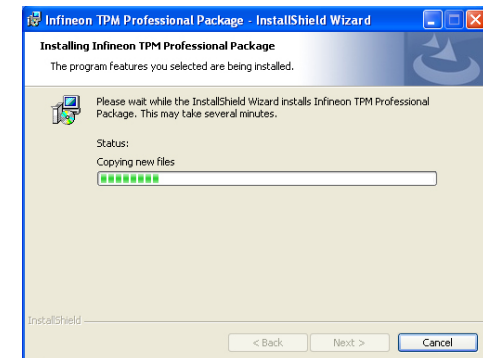

9. Click "Finish" to exit setup.



10. Click "Yes" to restart your system.

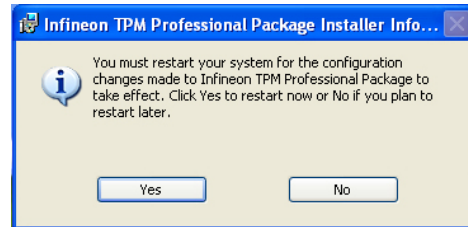

## Adobe Acrobat Reader 9.3

To install the reader, click "Adobe Acrobat Reader 9.3" on the main menu.

1. Click Next to install or click Change Destination Folder to select another folder.

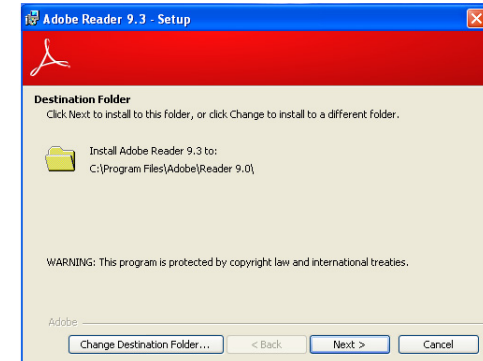

2. Click "Install" to begin installation.

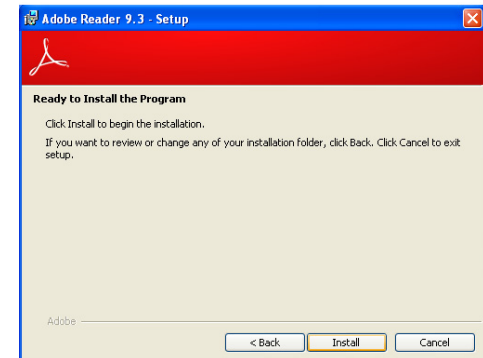

3. Click "Finish" to exit setup.

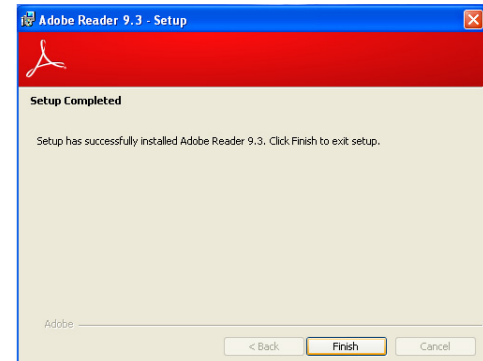

## Chapter 9 - RAID

The system board allows configuring RAID on Serial ATA drives. It supports RAID 0, RAID 1, and RAID 5.

### RAID Levels

#### RAID 0 (Striped Disk Array without Fault Tolerance)

RAID 0 uses two new identical hard disk drives to read and write data in parallel, interleaved stacks. Data is divided into stripes and each stripe is written alternately between two disk drives. This improves the I/O performance of the drives at different channel; however it is not fault tolerant. A failed disk will result in data loss in the disk array.

#### RAID 1 (Mirrored Disk Array with Fault Tolerance)

RAID 1 copies and maintains an identical image of the data from one drive to the other drive. If a drive fails to function, the disk array management software directs all applications to the other drive since it contains a complete copy of the drive's data. This enhances data protection and increases fault tolerance to the entire system. Use two new drives or an existing drive and a new drive but the size of the new drive must be the same or larger than the existing drive.

#### RAID 5 (Striped Disk Array with Distributed Parity)

RAID 5 stripes data and parity information across hard drives. It is fault tolerant and provides better hard drive performance and higher disk utilization than RAID 1.

RAID Level	Min. Drives	Protection	Description
RAID 0	2	None	Data striping without redundancy
RAID 1	2	Single Drive Failure	Disk mirroring
RAID 5	3	Single Drive Failure	Block-level data striping with distributed parity

## Settings

To enable the RAID function, the following settings are required.

1. Connect the Serial ATA drives.
2. Enable Serial ATA in the Insyde BIOS.
3. Create a RAID volume.
- 3-1. Create a RAID volume if the boot type is UEFI.
4. Install the Intel Rapid Storage Technology Utility.

### Step 1: Connect the Serial ATA Drives

Refer to Chapter 3 for details on connecting the Serial ATA drives.



#### Important:

1. Make sure you have installed the Serial ATA drives and connected the data cables otherwise you won't be able to enter the RAID BIOS utility.
2. Treat the cables with extreme caution especially while creating RAID. A damaged cable will ruin the entire installation process and operating system. The system will not boot and you will lost all data in the hard drives. Please give special attention to this warning because there is no way of recovering back the data.

### Step 2: Enable RAID in the Insyde BIOS

1. Power-on the system then press <Del> to enter the main menu of the BIOS setup utility.
2. Go to "Advanced" menu, and select the "SATA Configuration" menu.
3. Change the "SATA Mode Selection" to "RAID" mode.
4. Save the changes in the "Save & Exit" menu.
5. Reboot the system.



### Step 3: Create a RAID Volume

1. When the Intel® RST option ROM status screen displays during POST, press <Ctrl> and <I> simultaneously to enter the option ROM user interface.
2. Select 1: Create RAID Volume and press <Enter>.
3. Use the up or down arrow keys to select the RAID level and press <Enter>.
4. Use the up or down arrow keys to select the strip size and press <Enter>.
5. Press <Enter> to select the physical disks.
6. Use the up or down arrow keys to scroll through the list of hard drives and press <Space> to select the drive.
7. Press <Enter>.
8. Select the volume size and press <Enter>. You must select less than one hundred percent of the available volume space to leave space for the second volume.
9. Press <Enter> to create the volume.
10. At the prompt, press <Y> to confirm volume creation.
11. Select 4: Exit and press <Enter>.
12. Press <Y> to confirm exit.



**Note:**

These steps are cited from the Intel® Support site, "Set Up a System with Intel® Matrix RAID Technology" (Article ID: 000005789).  
<http://www.intel.com/content/www/us/en/support/boards-and-kits/000005789.html>

### Step 3-1: Create a RAID Volume if the boot type is UEFI

If the boot type is set to UEFI, RAID volume creation will be different. Please use the following steps to create RAID volumes. To set the boot type, enter the Insyde BIOS and go to "Boot" >"Boot type".

1. Go to the "Advanced" menu of the Insyde BIOS.
2. The "Intel® Rapid Storage Technology" menu appears. Enter this menu.

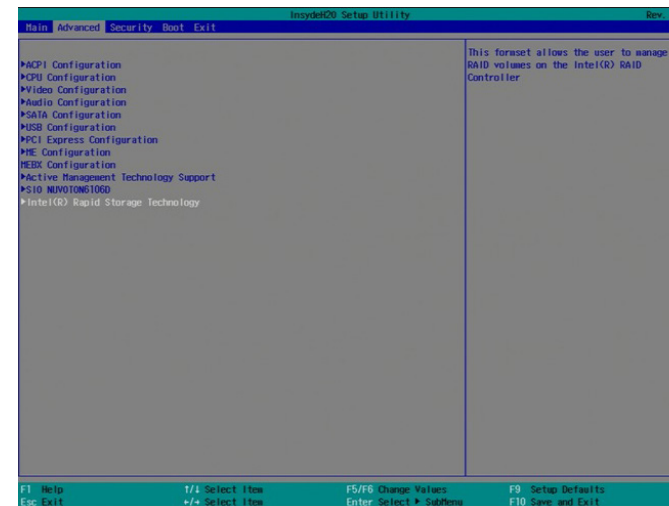

3. The screen displays all available drives. Select "Create RAID volume" to create a RAID volume".
4. Use the up or down arrow keys to select the RAID level and press <Enter>.
5. Use the up or down arrow keys to scroll through the list of hard drives and press <Space> to select the drive.
6. Press <Enter>.
7. Use the up or down arrow keys to select the strip size and press <Enter>.
8. Enter the volume size and press <Enter>.
9. At the prompt, press <Y> to confirm volume creation.

## Step 4: Install the Intel Rapid Storage Technology Utility

The Intel Rapid Storage Technology Utility can be installed from within Windows. It allows RAID volume management (create, delete, migrate) from within the operating system. It will also display useful SATA device and RAID volume information. The user interface, tray icon service and monitor service allow you to monitor the current status of the RAID volume and/or SATA drives. It enables enhanced performance and power management for the storage subsystem.

1. Insert the provided DVD into an optical drive.
2. Click "Intel Rapid Storage Technology Utility" on the main menu.
3. Setup is ready to install the utility. Click Next.

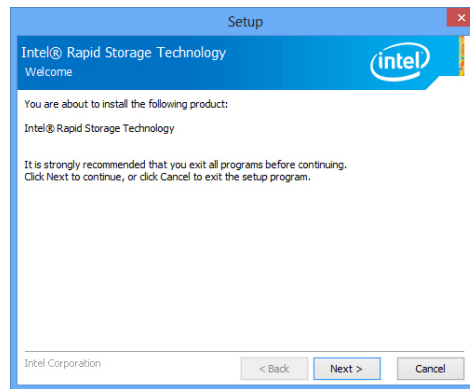

4. Read the license agreement and click "I accept the terms in the License Agreement." Then, click Next.

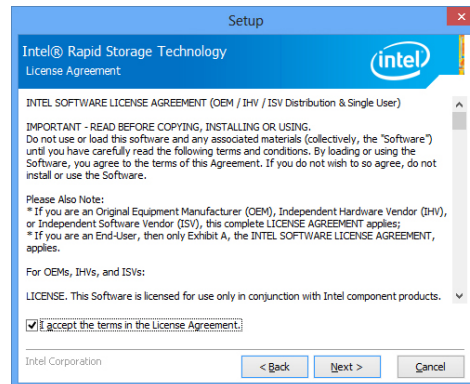

5. Go through the readme document to view system requirements and installation information then click Next.

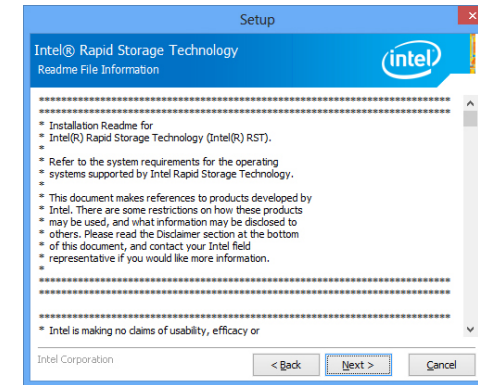

6. Click Next to install to the default folder or click change to choose another destination folder.

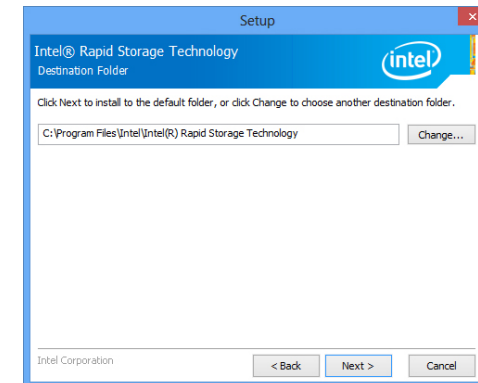

7. Confirm the installation and click Next.

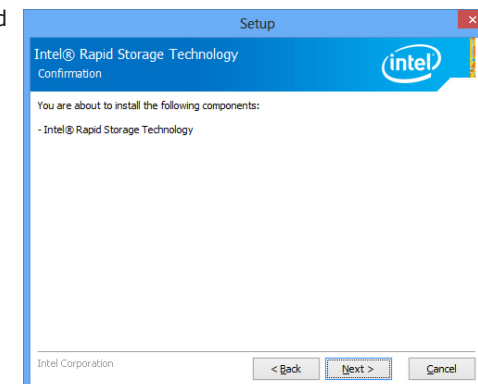

8. Click “Yes, I want to restart this computer now” to complete the installation and then click Finish.



## Chapter 10 - Intel AMT Settings

### Overview

Intel Active Management Technology (Intel® AMT) combines hardware and software solutions to provide maximum system defense and protection to networked systems.

The hardware and software information are stored in non-volatile memory. With its built-in manageability and the latest security applications, Intel® AMT provides the following functions.

- **Discover**

Allows remote access and management of networked systems even while PCs are powered off; significantly reducing desk-side visits.

- **Repair**

Remotely repair systems after OS failures. Alerting and event logging help detect problems quickly to reduce downtime.

- **Protect**

Intel AMT's System Defense capability remotely updates all systems with the latest security software. It protects the network from threats at the source by proactively blocking incoming threats, reactively containing infected clients before they impact the network, and proactively alerting when critical software agents are removed.

### Enable Intel® AMT in the BIOS

1. Power on the system then press <Del> to enter the main menu of the BIOS setup utility.
2. In the "Advanced" menu, select "Active Management Technology Support".

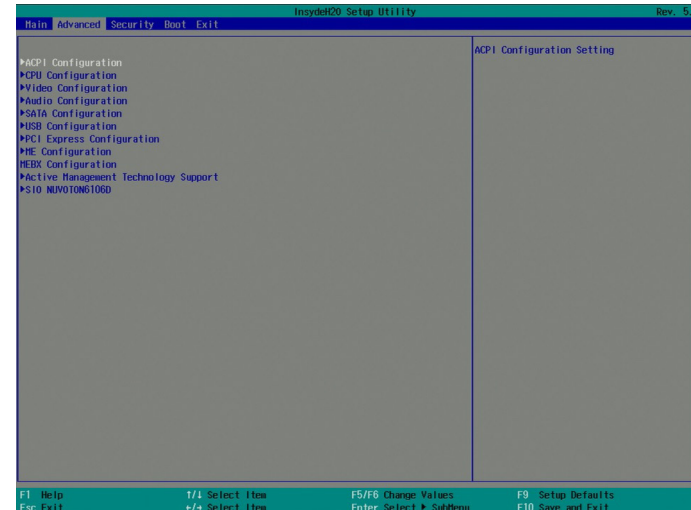

3. In the "Active Management Technology Support" menu, select "Enabled" for "Intel AMT Support".

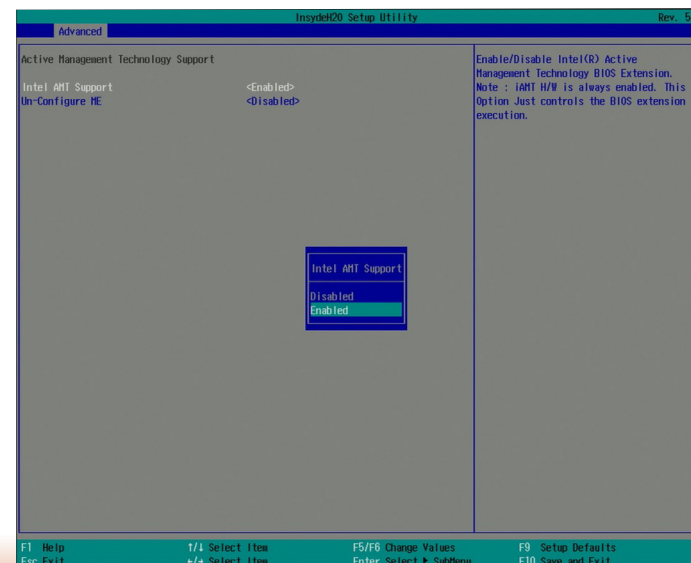

- In the "Exit" menu, select "Exit Saving Changes" and then select "OK".

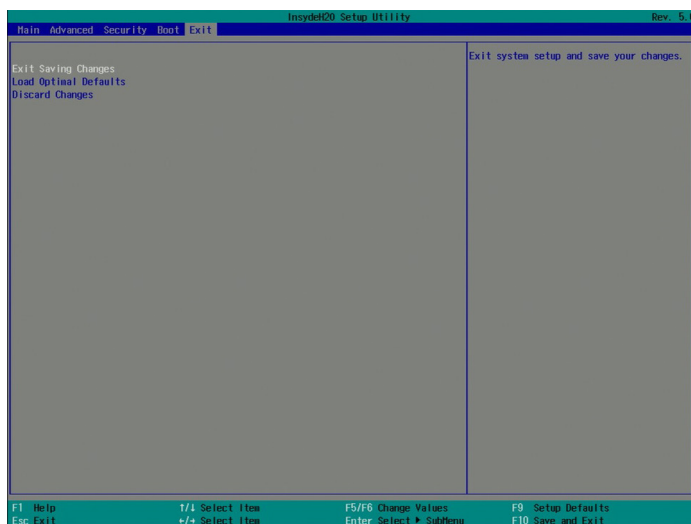

## Set up Intel® AMT using the Intel® Management Engine BIOS Extension (MEBX)

- After the system reboots, press <Del> to enter the BIOS menu again.
- In the "Advanced" menu, select "MEBX Configuration" to enter the Manageability Engine BIOS Extension (MEBx) Setup.
- When the system reboots, you will be prompted for a password. The default password is "admin". Enter the default password in the space provided under Intel(R) ME Password, then press "Enter".

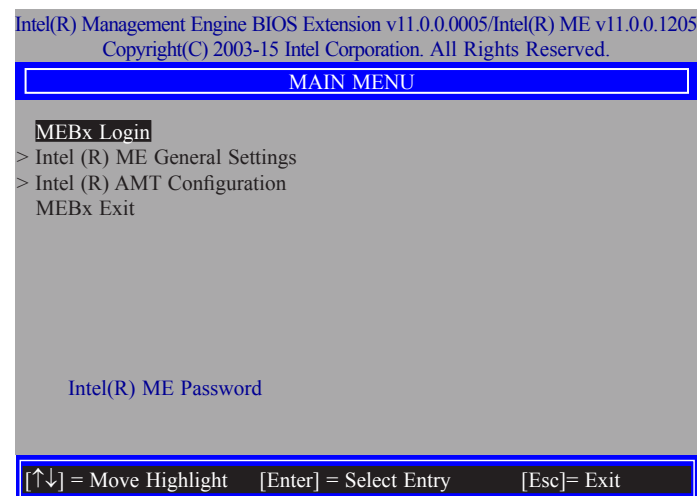

4. Enter a password in the space provided under "Intel(R) ME Password" and then press "Enter". The password must include:

- 8-32 characters
- Strong 7-bit ASCII characters excluding : , and " characters
- At least one digit character (0, 1, ...9)
- At least one 7-bit ASCII non alpha-numeric character, above 0x20, (e.g. !, \$, ;)
- Both lower case and upper case characters

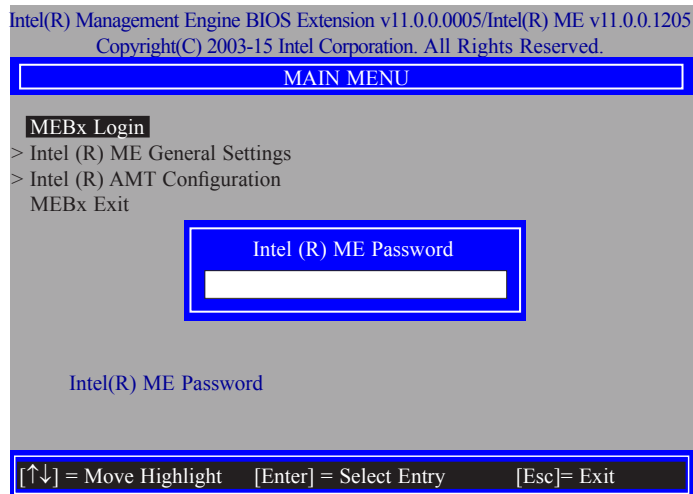

5. You will be asked to verify the password. Enter the same new password in the space provided under "Verify Password" and then press "Enter".

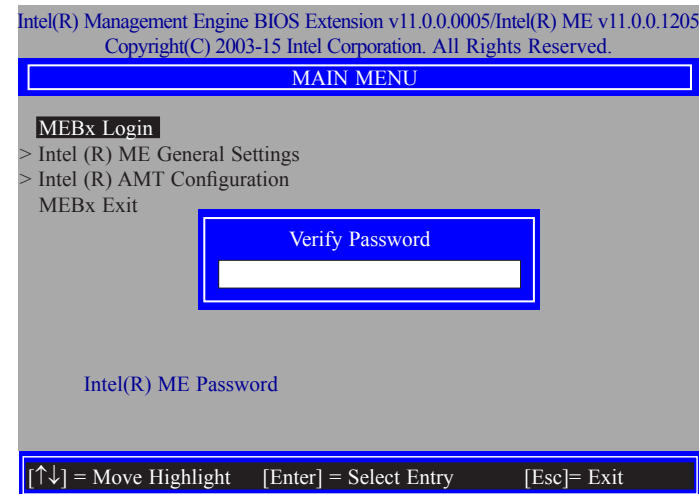

6. Select "Intel(R) ME General Settings" and then press "Enter".

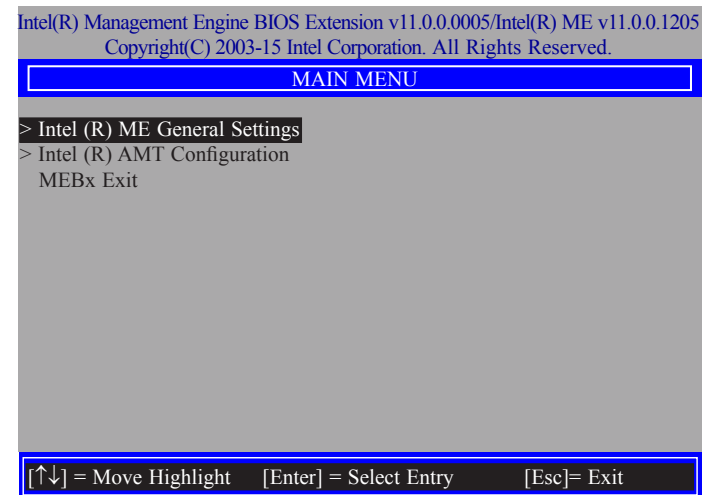

7. Select "Change Intel(R) ME Password" and then press "Enter".

You will be prompted for a password. The default password is "admin". Enter the default password in the space provided under "Intel(R) ME New Password" and then press "Enter".

- 8-32 characters
- Strong 7-bit ASCII characters excluding : , and " characters
- At least one digit character (0, 1, ...9)
- At least one 7-bit ASCII non alpha-numeric character, above 0x20, (e.g. !, \$, ;)
- Both lower case and upper case characters

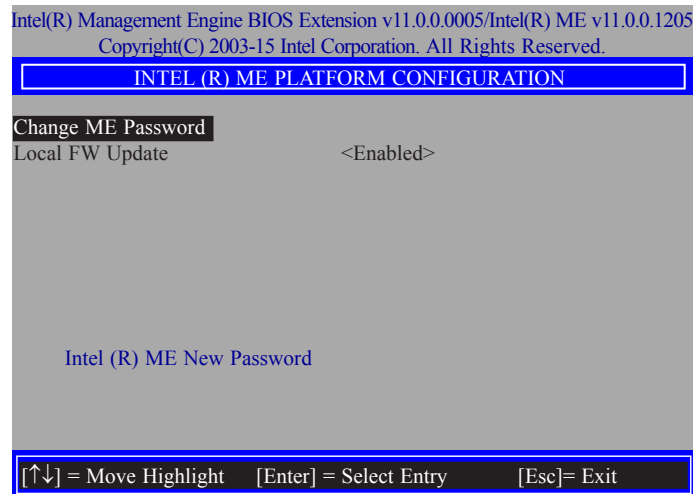

8. Select "Local FW Update" and then press "Enter". Select "Enabled" or "Disabled" or "Password Protected" and then press "Enter".

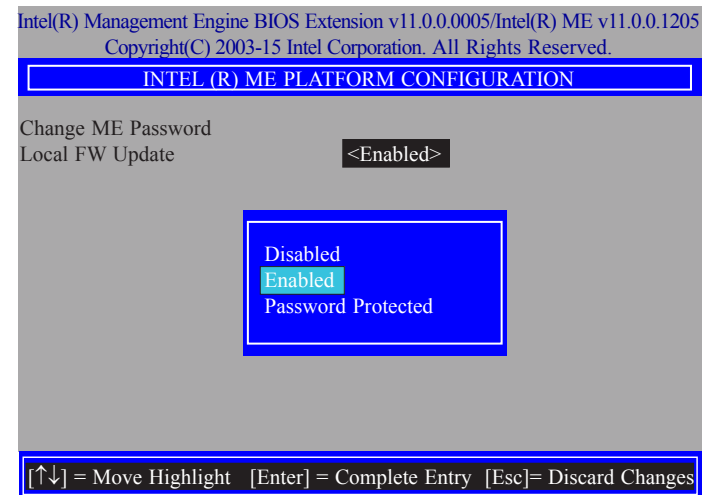

9. Select Previous Menu until you return to the "Main Menu". Select "Intel(R) AMT Configuration" and then press "Enter".

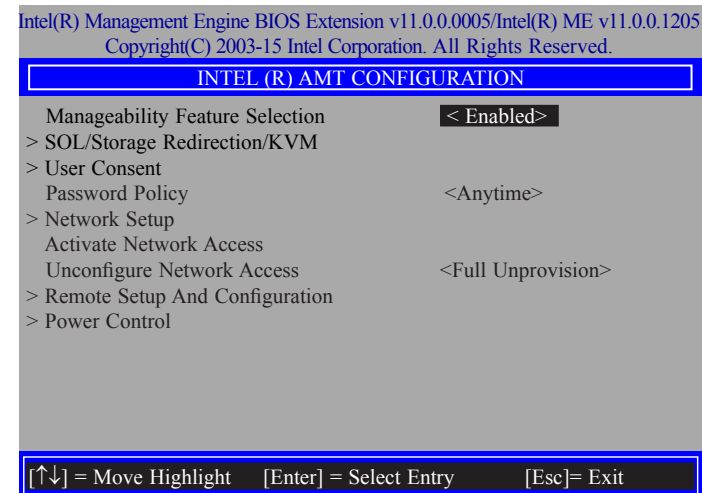

10. In the "Intel(R) AMT Configuration" menu, select "Manageability Feature Selection" and then press "Enter". Select "Enabled" or "Disabled" and then press "Enter".

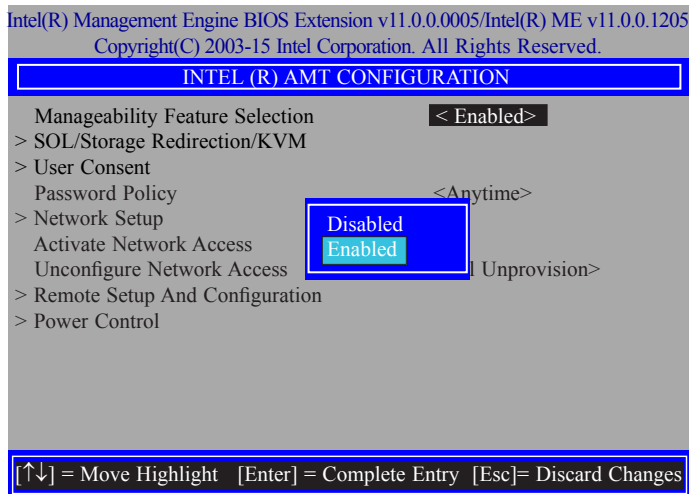

12. In the "SOL/Storage Redirection/KVM" menu, select "Username and Password" and then press "Enter". Select "Enabled" or "Disabled" and then press "Enter".

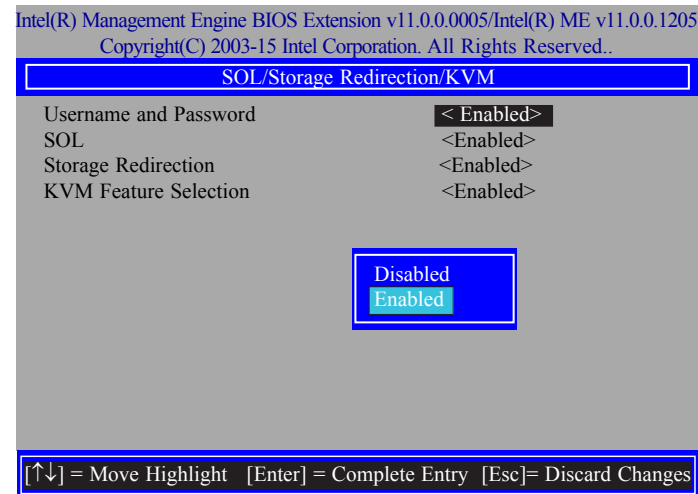

11. In the "Intel(R) AMT Configuration" menu, select "SOL/Storage Redirection/KVM" and then press "Enter".

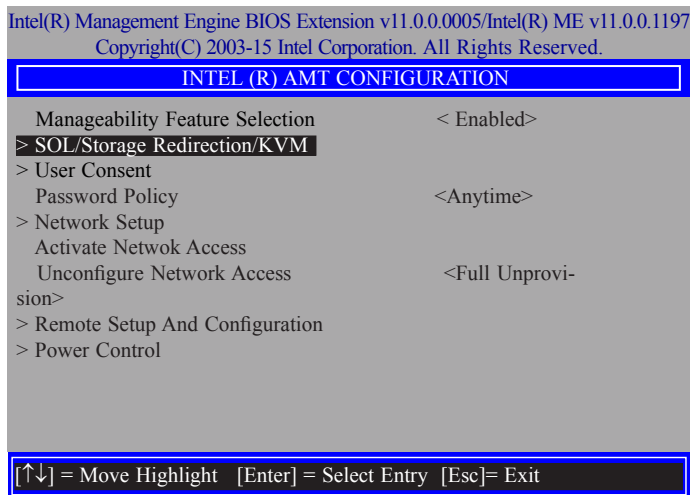

13. In the "SOL/Storage Redirection/KVM" menu, select "SOL" and then press "Enter". Select "Enabled" or "Disabled" and then press "Enter".

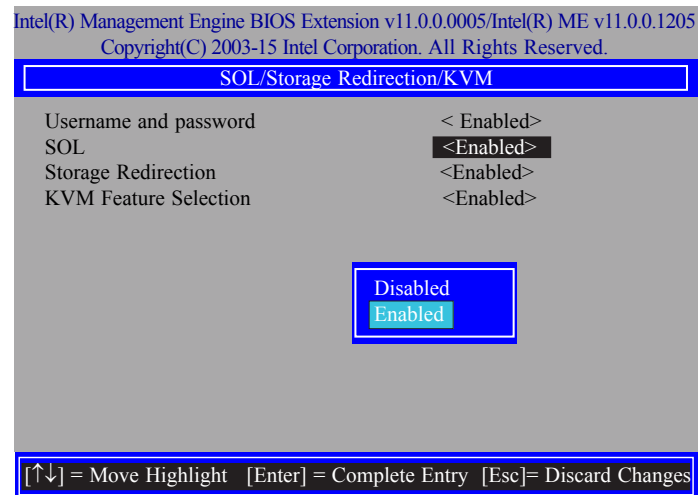



14. In the "SOL/Storage Redirection/KVM" menu, select "Storage Redirection" and then press "Enter". Select "Enabled" or "Disabled" and then press "Enter".

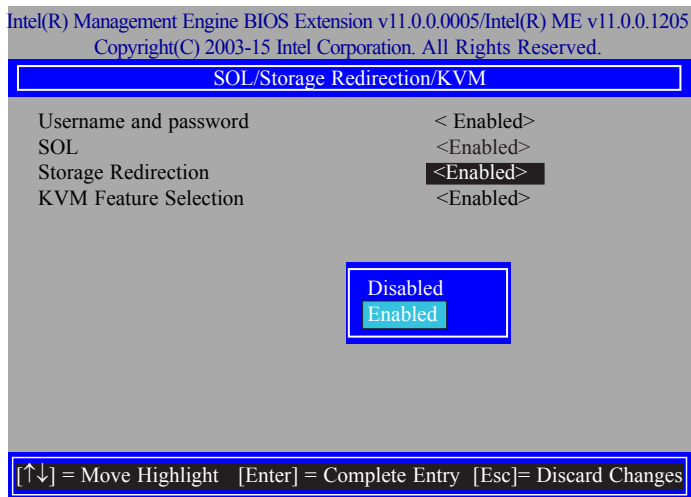

15. In the "SOL/IDER/KVM" menu, select "KVM Feature Selection" and then press "Enter". Select "Enabled" or "Disabled" and then press "Enter".

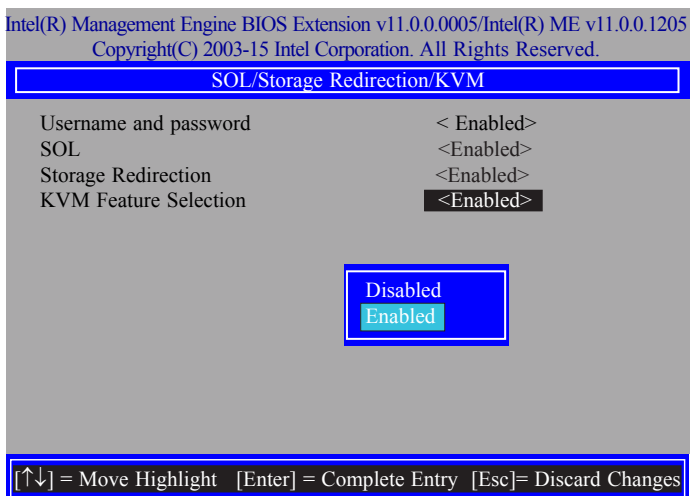

16. Select Previous Menu until you return to the "Intel(R) AMT Configuration" menu. Select "User Consent" and then press "Enter".

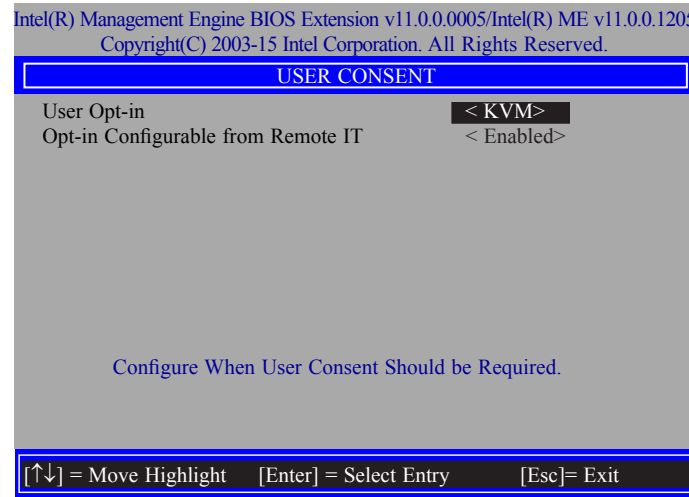

17. In the "User Consent" menu, select "User Opt-in" and then press "Enter". Select "None" or "KVM" or "ALL" and then press "Enter".

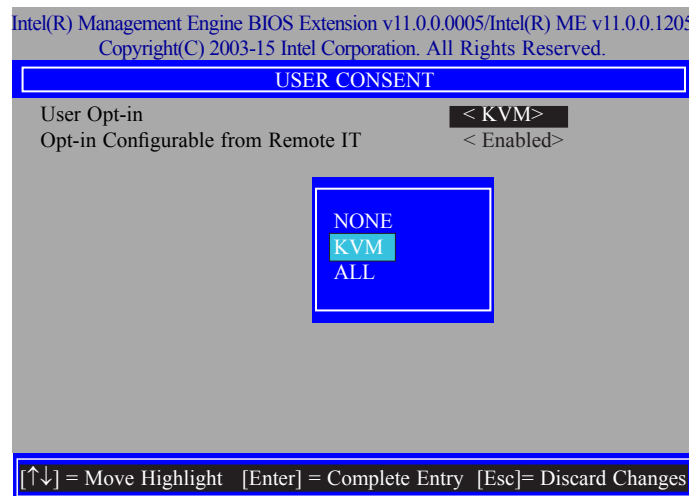

18. In the "User Consent" menu, select "Opt-in Configurable from Remote IT" and then press "Enter". Select "Enabled" or "Disable Remote Control of KVM Opt-in Policy" and then press "Enter".

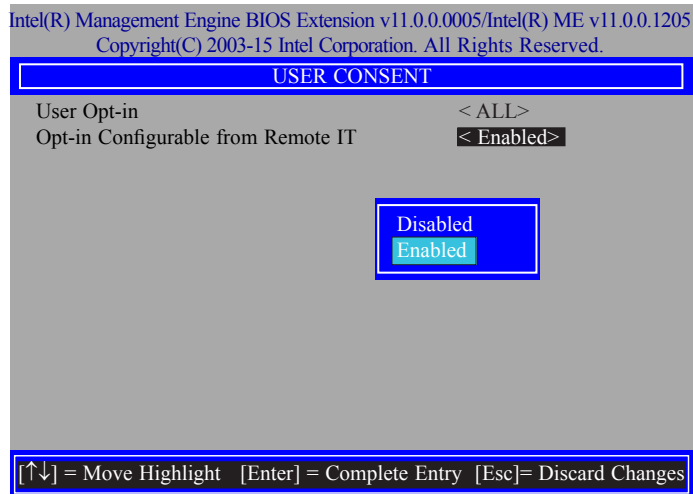

19. Select Previous Menu until you return to the "Intel(R) AMT Configuration" menu. Select "Password Policy" and then press "Enter". You may choose to use a password only during setup and configuration or to use a password anytime the system is being accessed.

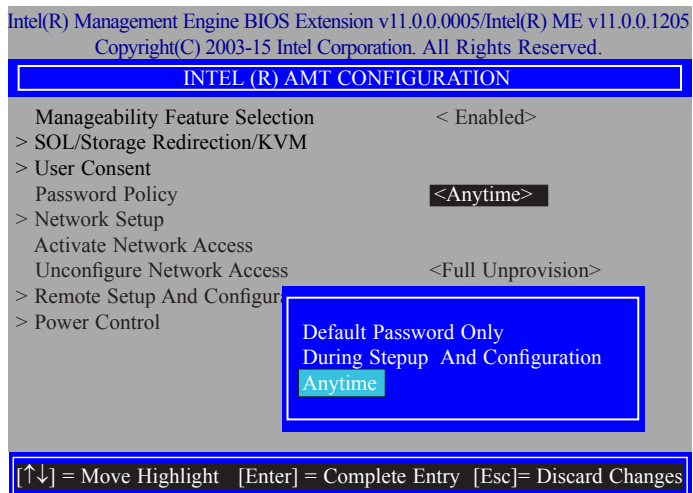

20. In the "Intel(R) AMT Configuration" menu, select "Network Setup" and then press "Enter".

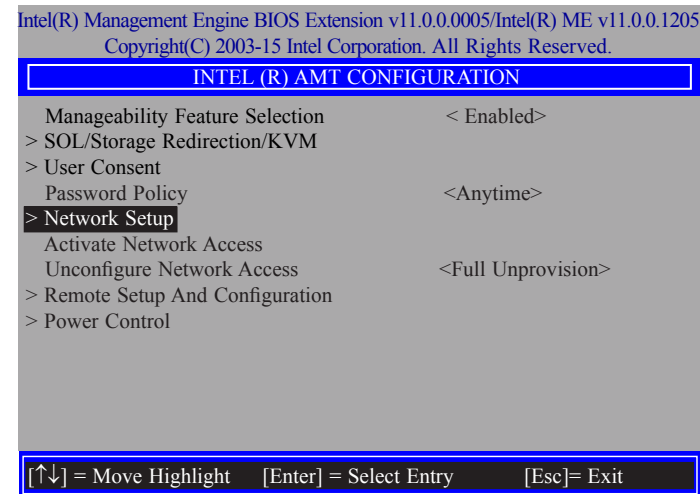

21. In the "Intel(R) ME Network Setup" menu, select "Intel(R) ME Network Name Settings" and then press "Enter".

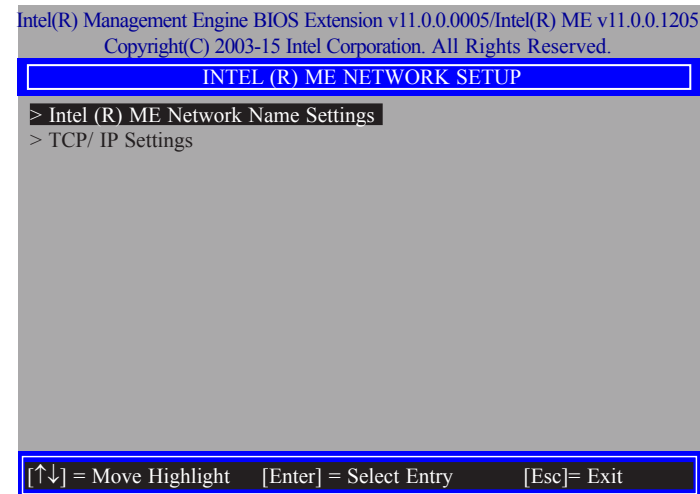

22. In the "Intel(R) ME Network Name Settings" menu, select "Host Name" and then press "Enter". Enter the computer's host name and then press "Enter".

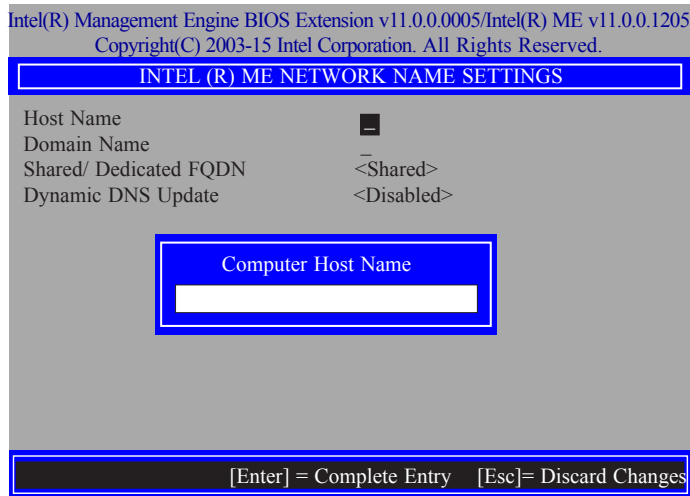

24. Select "Shared/Dedicated FQDN" and then press "Enter". Select "Shared" or "Dedicated" and then press "Enter".

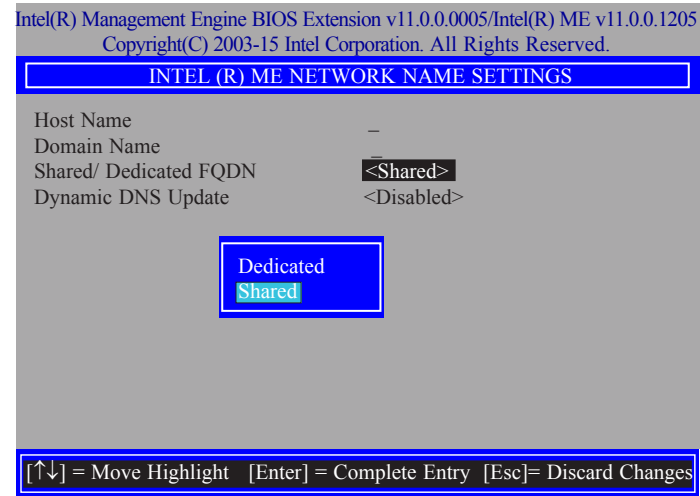

23. Select "Domain Name" and then press "Enter". Enter the computer's domain name and then press "Enter".

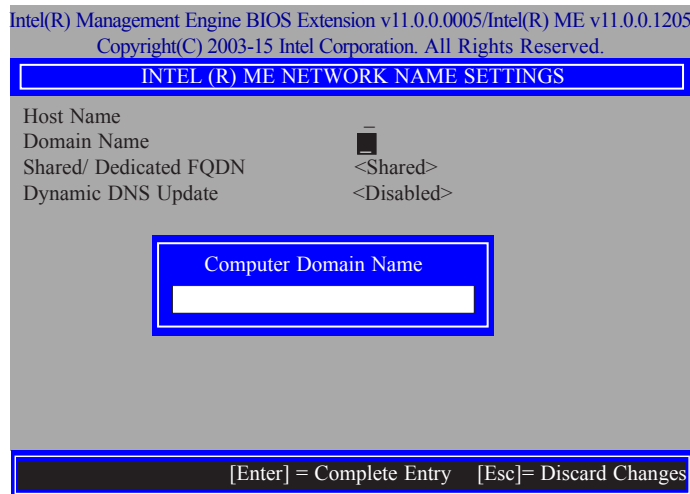

25. Select "Dynamic DNS Update" and then press "Enter". Select "Enabled" or "Disabled" and then press "Enter".

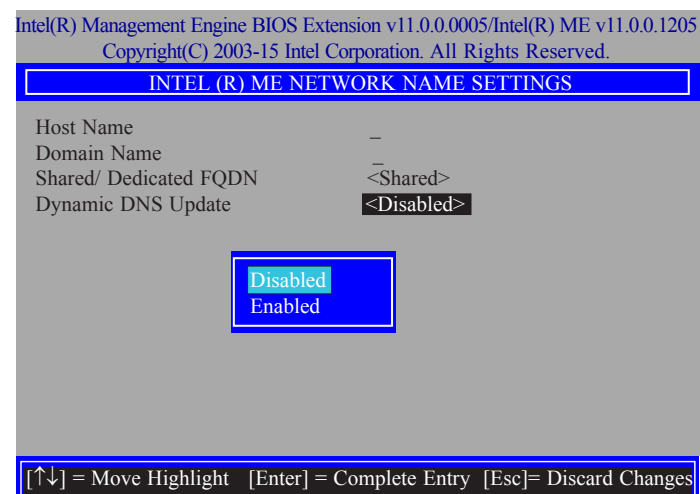

26. Select Previous Menu until you return to the "Intel(R) ME Network Setup" menu. Select "TCP/IP Settings" and then press "Enter".

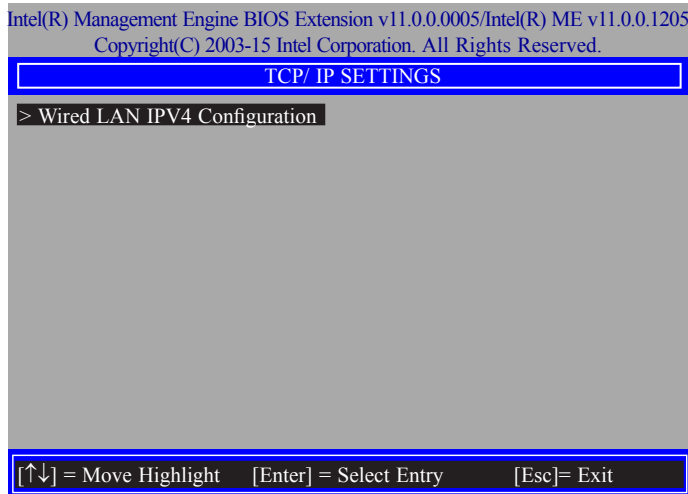

28. In the "Intel(R) AMT Configuration" menu, select "Activate Network Access" and then select "Yes/No" and press "Enter".

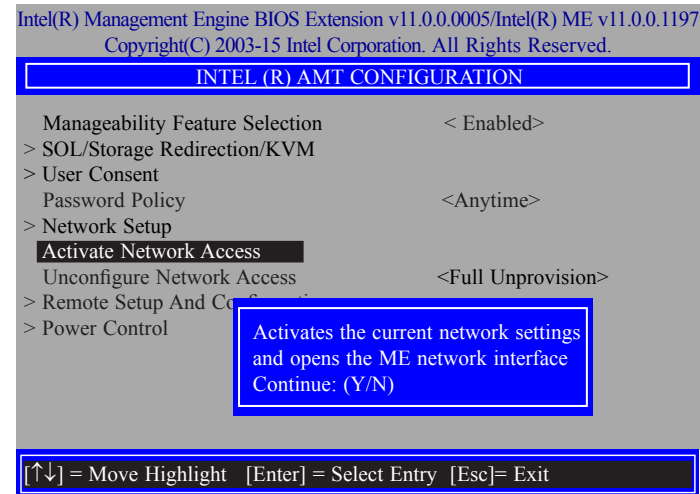

27. In the "TCP/IP Settings" menu, select "Wired LAN IPV4 Configuration" and then press "Enter".

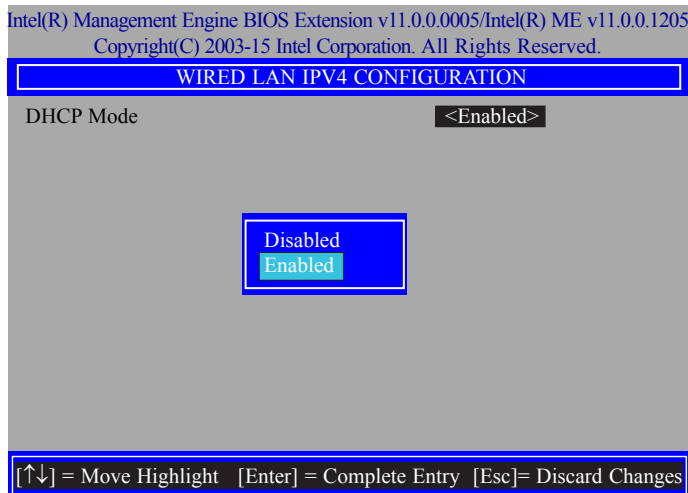

29. In the "Intel(R) AMT Configuration" menu, select "Unconfigure Network Access" and then press "Enter".

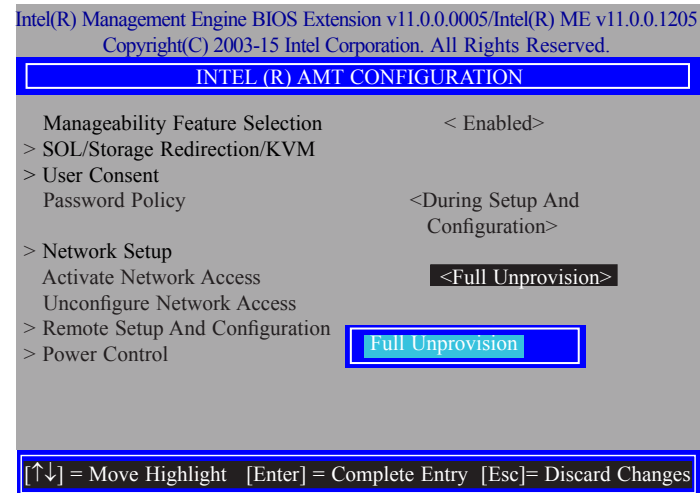

30. In the "Intel(R) AMT Configuration" menu, select "Remote Setup And Configuration" and then press "Enter".

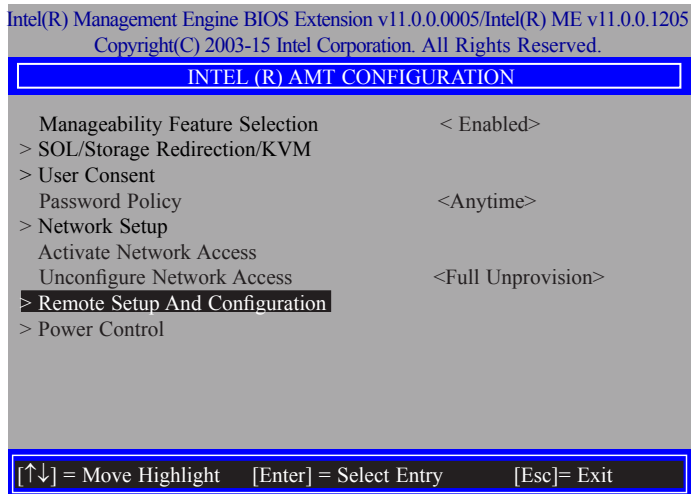

31. In the "Intel(R) Remote Setup And Configuration" menu, select "Current Provisioning Mode" and then press "Enter".

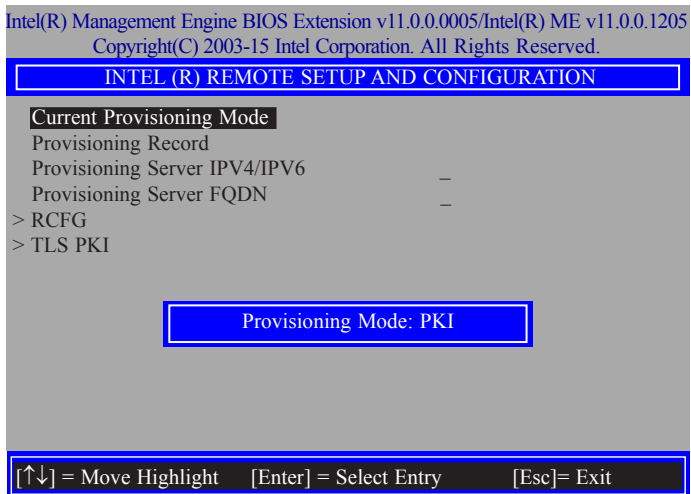

32. In the "Intel(R) Remote Setup And Configuration" menu, select "Provisioning Record" and then press "Enter".

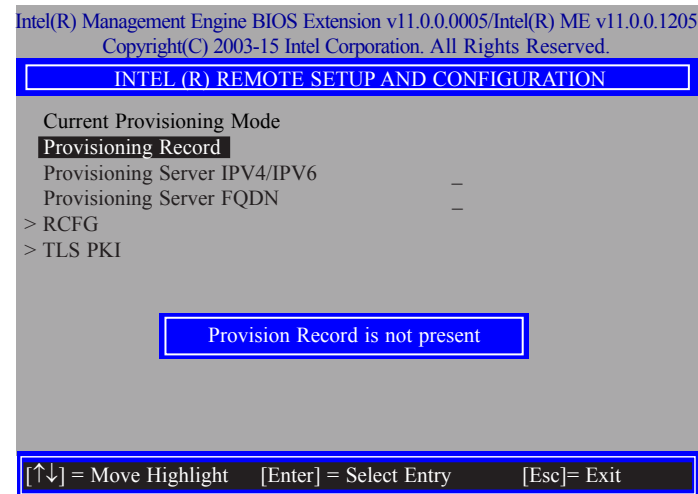

33. In the "Intel(R) Remote Setup And Configuration" menu, select "Provisioning server IPV4/IPV6", enter "Provisioning server address" and then press "Enter".



34. In the "Intel(R) Remote Setup And Configuration" menu, select "Provisioning server FQDN", enter the FQDN of Provisioning server, and then press "Enter".

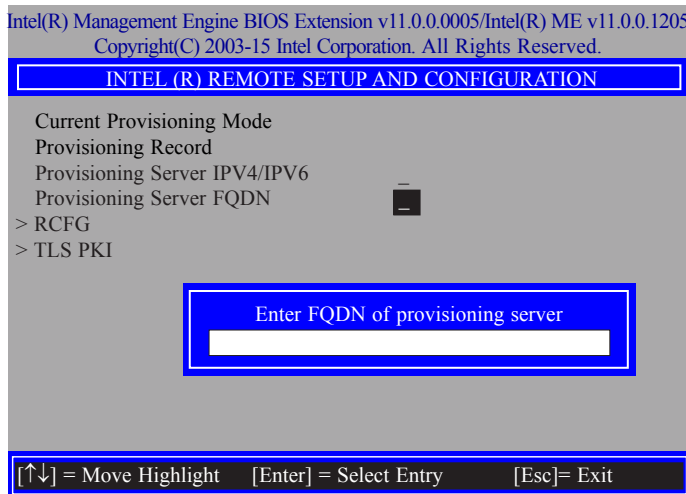

36. In the "Intel(R) Remote Setup And Configuration" menu, select "TLS PKI" and then press "Enter".

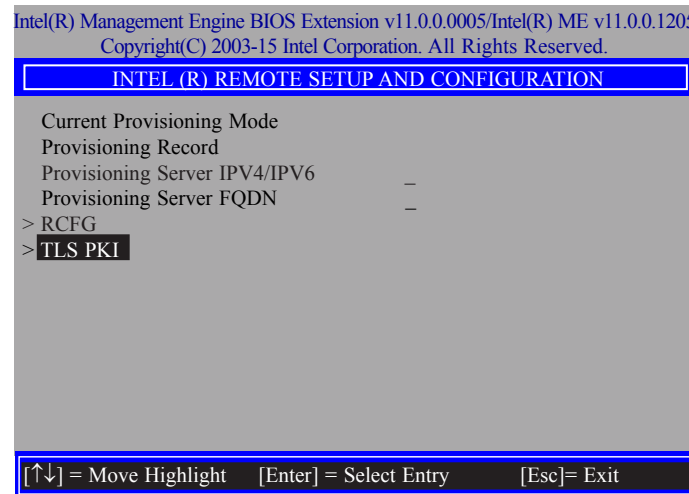

35. In the "Intel(R) Remote Setup And Configuration" menu, select "RCFG" and press "Enter", and then select "Start Configuration Y/N" and press "enter".

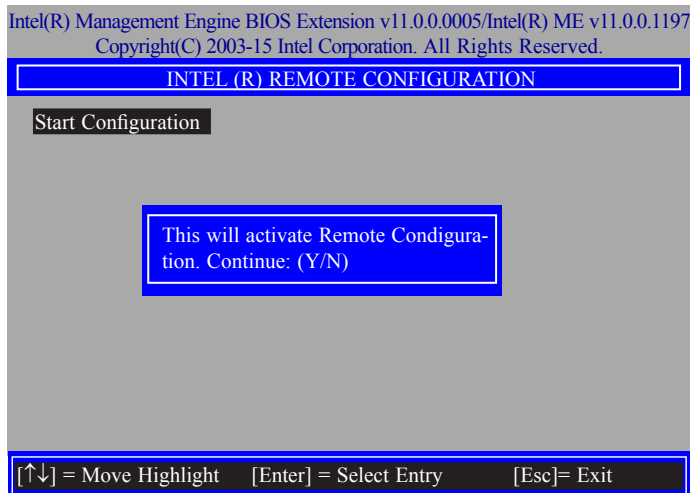

37. In the "Intel(R) Remote Configuration" menu, select "Remote Configuration\*\*" and press "Enter", and then select "Enabled" or "Disabled" and press "Enter".

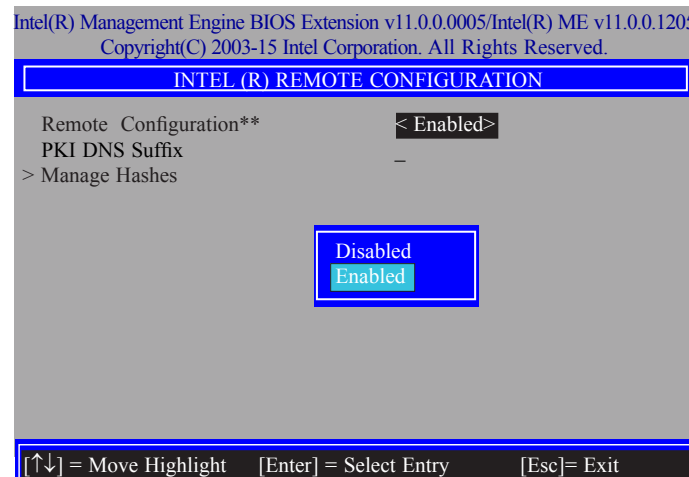

38. Select "PKI DNS Suffix", enter the "PKI DNS Suffix", and then press "Enter".

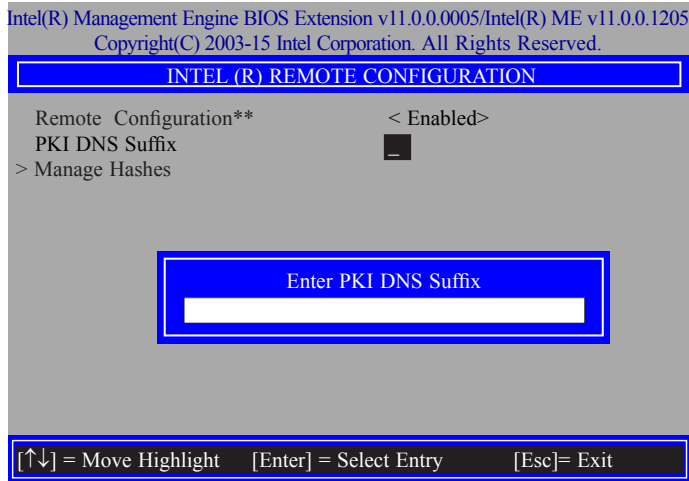

39. Select "Manage Hashes" and press "Enter", and then select one of the hash names.

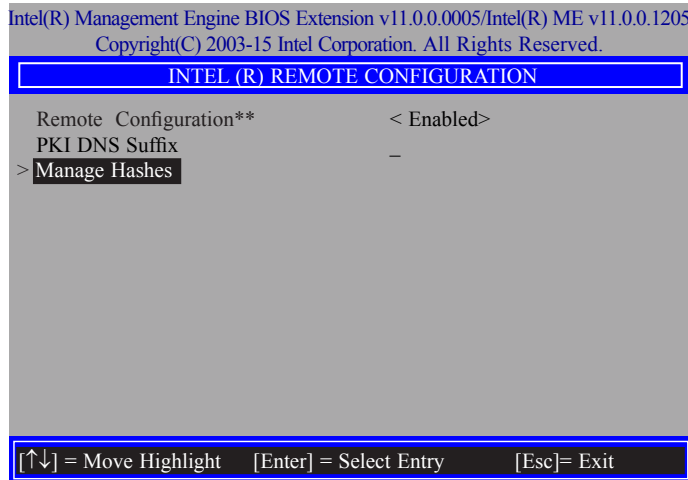

40. In the "Intel(R) AMT Configuration" menu, select Power Control, and then press "Enter".

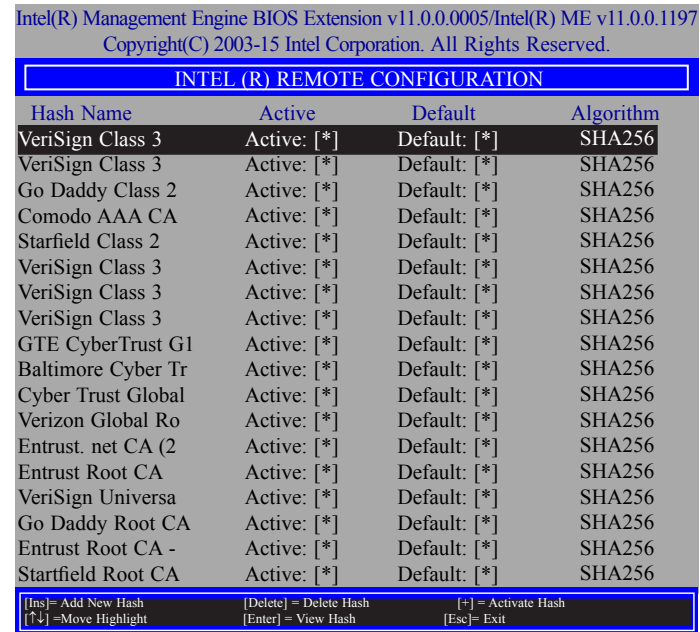

41. In the "Intel(R) AMT Power Control" menu, select "Intel(R) AMT ON in Host Sleep States" and then press "Enter". Select an option and then press "Enter".

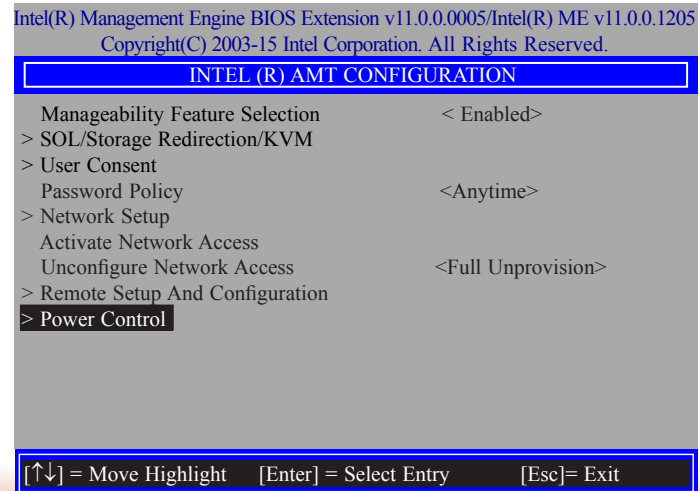

42. In the "Intel(R) AMT Power Control" menu, select "Idle Timeout" and then press "Enter". Enter the timeout value (1-65535).

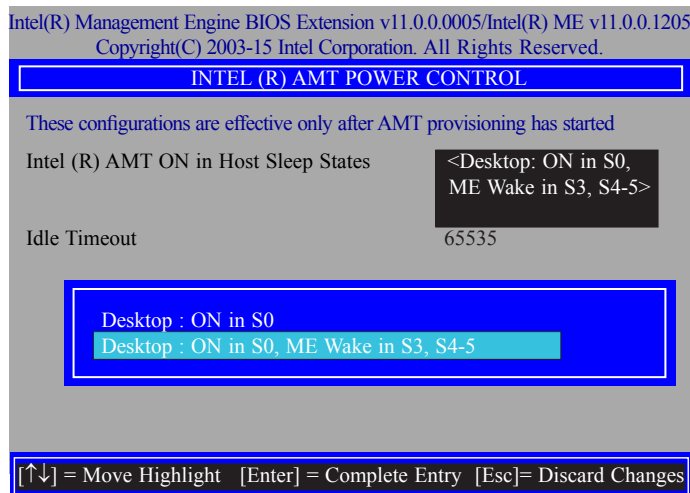

43. In the "Intel(R) AMT Power Control" menu, select "Idle Timeout" and then press "Enter". Enter the timeout value (1-65535).

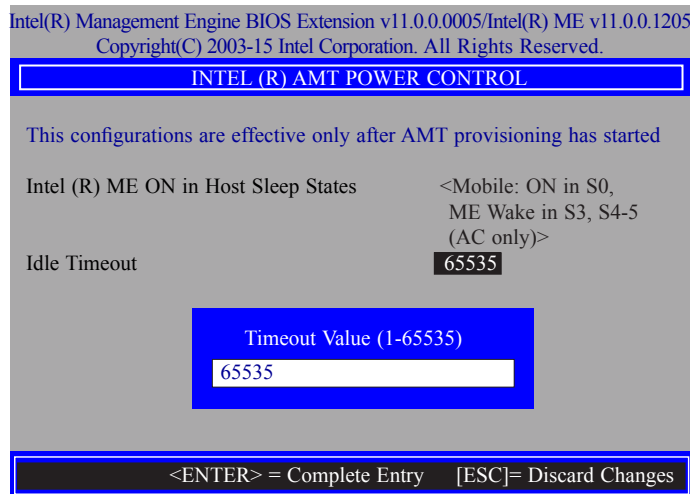

44. Select Previous Menu until you return to the "Main Menu". Select "Exit" and then press "Enter". Type "Y" and then press "Enter".

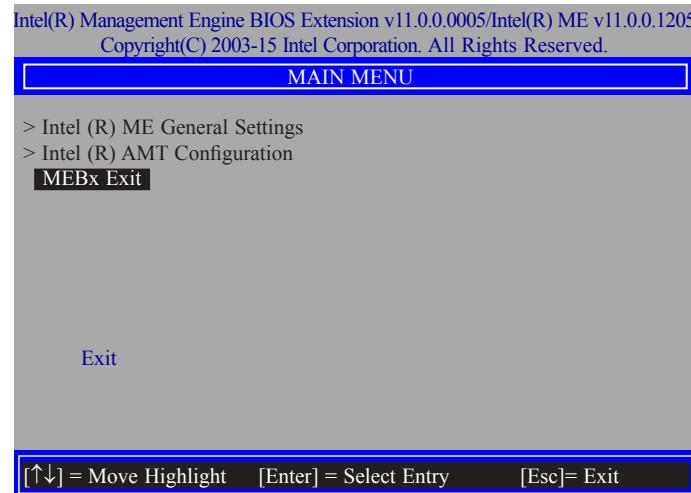



## Appendix A - Troubleshooting Checklist

### Troubleshooting Checklist

This chapter of the manual is designed to help you with problems that you may encounter with your personal computer. To efficiently troubleshoot your system, treat each problem individually. This is to ensure an accurate diagnosis of the problem in case a problem has multiple causes.

Some of the most common things to check when you encounter problems while using your system are listed below.

1. The power switch of each peripheral device is turned on.
2. All cables and power cords are tightly connected.
3. The electrical outlet to which your peripheral devices are connected is working. Test the outlet by plugging in a lamp or other electrical device.
4. The monitor is turned on.
5. The display's brightness and contrast controls are adjusted properly.
6. All add-in boards in the expansion slots are seated securely.
7. Any add-in board you have installed is designed for your system and is set up correctly.

### Monitor/Display

#### If the display screen remains dark after the system is turned on:

1. Make sure that the monitor's power switch is on.
2. Check that one end of the monitor's power cord is properly attached to the monitor and the other end is plugged into a working AC outlet. If necessary, try another outlet.
3. Check that the video input cable is properly attached to the monitor and the system's display adapter.
4. Adjust the brightness of the display by turning the monitor's brightness control knob.

#### The picture seems to be constantly moving.

1. The monitor has lost its vertical sync. Adjust the monitor's vertical sync.
2. Move away any objects, such as another monitor or fan, that may be creating a magnetic field around the display.
3. Make sure your video card's output frequencies are supported by this monitor.

#### The screen seems to be constantly wavering.

1. If the monitor is close to another monitor, the adjacent monitor may need to be turned off. Fluorescent lights adjacent to the monitor may also cause screen wavering.

### Power Supply

#### When the computer is turned on, nothing happens.

1. Check that one end of the AC power cord is plugged into a live outlet and the other end properly plugged into the back of the system.
2. Make sure that the voltage selection switch on the back panel is set for the correct type of voltage you are using.
3. The power cord may have a "short" or "open". Inspect the cord and install a new one if necessary.

### Floppy Drive

#### The computer cannot access the floppy drive.

1. The floppy diskette may not be formatted. Format the diskette and try again.
2. The diskette may be write-protected. Use a diskette that is not write-protected.
3. You may be writing to the wrong drive. Check the path statement to make sure you are writing to the targeted drive.
4. There is not enough space left on the diskette. Use another diskette with adequate storage space.

## Hard Drive

### Hard disk failure.

1. Make sure the correct drive type for the hard disk drive has been entered in the BIOS.
2. If the system is configured with two hard drives, make sure the bootable (first) hard drive is configured as Master and the second hard drive is configured as Slave. The master hard drive must have an active/bootable partition.

### Excessively long formatting period.

If your hard drive takes an excessively long period of time to format, it is likely a cable connection problem. However, if your hard drive has a large capacity, it will take a longer time to format.

## Serial Port

### The serial device (modem, printer) doesn't output anything or is outputting garbled characters.

1. Make sure that the serial device's power is turned on and that the device is on-line.
2. Verify that the device is plugged into the correct serial port on the rear of the computer.
3. Verify that the attached serial device works by attaching it to a serial port that is working and configured correctly. If the serial device does not work, either the cable or the serial device has a problem. If the serial device works, the problem may be due to the onboard I/O or the address setting.
4. Make sure the COM settings and I/O address are configured correctly.

## Keyboard

### Nothing happens when a key on the keyboard was pressed.

1. Make sure the keyboard is properly connected.
2. Make sure there are no objects resting on the keyboard and that no keys are pressed during the booting process.

## System Board

1. Make sure the add-in card is seated securely in the expansion slot. If the add-in card is loose, power off the system, re-install the card and power up the system.
2. Check the jumper settings to ensure that the jumpers are properly set.
3. Verify that all memory modules are seated securely into the memory sockets.
4. Make sure the memory modules are in the correct locations.
5. If the board fails to function, place the board on a flat surface and seat all socketed components. Gently press each component into the socket.
6. If you made changes to the BIOS settings, re-enter setup and load the BIOS defaults.