

AL171/AL173

Mini-ITX Industrial Motherboard

User's Manual

Copyright

This publication contains information that is protected by copyright. No part of it may be reproduced in any form or by any means or used to make any transformation/adaptation without the prior written permission from the copyright holders.

This publication is provided for informational purposes only. The manufacturer makes no representations or warranties with respect to the contents or use of this manual and specifically disclaims any express or implied warranties of merchantability or fitness for any particular purpose. The user will assume the entire risk of the use or the results of the use of this document. Further, the manufacturer reserves the right to revise this publication and make changes to its contents at any time, without obligation to notify any person or entity of such revisions or changes.

Changes after the publication's first release will be based on the product's revision. The website will always provide the most updated information.

© 2018. All Rights Reserved.

Trademarks

Product names or trademarks appearing in this manual are for identification purpose only and are the properties of the respective owners.

FCC and DOC Statement on Class B

This equipment has been tested and found to comply with the limits for a Class B digital device, pursuant to Part 15 of the FCC rules. These limits are designed to provide reasonable protection against harmful interference when the equipment is operated in a residential installation. This equipment generates, uses and can radiate radio frequency energy and, if not installed and used in accordance with the instruction manual, may cause harmful interference to radio communications. However, there is no guarantee that interference will not occur in a particular installation. If this equipment does cause harmful interference to radio or television reception, which can be determined by turning the equipment off and on, the user is encouraged to try to correct the interference by one or more of the following measures:

- Reorient or relocate the receiving antenna.
- Increase the separation between the equipment and the receiver.
- Connect the equipment into an outlet on a circuit different from that to which the receiver is connected.
- Consult the dealer or an experienced radio TV technician for help.

Notice:

1. The changes or modifications not expressly approved by the party responsible for compliance could void the user's authority to operate the equipment.
2. Shielded interface cables must be used in order to comply with the emission limits.

Table of Contents

Copyright.....	2
Trademarks	2
FCC and DOC Statement on Class B.....	2
Warranty.....	4
Static Electricity Precautions.....	4
Safety Measures	4
About the Package.....	5
Optional Items.....	5
Before Using the System Board.....	5
Chapter 1 - Introduction	6
Specifications	6
Features.....	7
Chapter 2 - Hardware Installation.....	8
Board Layout.....	8
Block Diagram.....	8
Mechanical Diagram	9
System Memory.....	9
Installing the DIMM Module	10
Installing the Heat Sink	11
Jumper Settings	12
Clear CMOS Data	12
SATA 1/M.2 B Key SATA Signal Select.....	13
M.2 Signal Select.....	13
COM1/COM2 RS232/Power Select.....	14
LCD/Inverter Power Select	15
Backlight Power Select.....	15
Panel Power Select	16
PCIE1/M.2 B Key PCIE Signal Select	16
Rear Panel I/O Ports.....	17
12V DC-in (AL171)/15~36V (AL173).....	17
Graphics Interface	18
RJ45 LAN Ports.....	18
USB Ports.....	19
Audio	19
I/O Connectors	20

SATA (Serial ATA) Connectors.....	20
SATA (Serial ATA) Power Connectors.....	20
S/PDIF Connector	21
Digital I/O and Power Connectors.....	21
Cooling Fan Connectors.....	22
Front Panel Connector	22
COM (Serial) Ports.....	23
LVDS LCD Panel Connector	24
LCD/Inverter Power Connector	24
SMBus Connector	25
Standby Power LED	25
Chassis Intrusion Connector	26
Expansion Slots	26
LPC Connector.....	27
Connecting the EXT-RS232/RS485 Card to the Motherboard	27
eDP Connector (optional)	28
Battery.....	29

Chapter 3 - BIOS Setup	30
Overview.....	30
Insyde BIOS Setup Utility.....	31
Main	31
Advanced	31
Security.....	39
Boot.....	40
Exit.....	41
Updating the BIOS	42
Notice: BIOS SPI ROM	42
Chapter 4 - Supported Software	43
Appendix A - Troubleshooting Checklist.....	49

Warranty

1. Warranty does not cover damages or failures that arised from misuse of the product, inability to use the product, unauthorized replacement or alteration of components and product specifications.
2. The warranty is void if the product has been subjected to physical abuse, improper installation, modification, accidents or unauthorized repair of the product.
3. Unless otherwise instructed in this user's manual, the user may not, under any circumstances, attempt to perform service, adjustments or repairs on the product, whether in or out of warranty. It must be returned to the purchase point, factory or authorized service agency for all such work.
4. We will not be liable for any indirect, special, incidental or consequential damages to the product that has been modified or altered.

Static Electricity Precautions

It is quite easy to inadvertently damage your PC, system board, components or devices even before installing them in your system unit. Static electrical discharge can damage computer components without causing any signs of physical damage. You must take extra care in handling them to ensure against electrostatic build-up.

1. To prevent electrostatic build-up, leave the system board in its anti-static bag until you are ready to install it.
2. Wear an antistatic wrist strap.
3. Do all preparation work on a static-free surface.
4. Hold the device only by its edges. Be careful not to touch any of the components, contacts or connections.
5. Avoid touching the pins or contacts on all modules and connectors. Hold modules or connectors by their ends.



Important:

Electrostatic discharge (ESD) can damage your processor, disk drive and other components. Perform the upgrade instruction procedures described at an ESD workstation only. If such a station is not available, you can provide some ESD protection by wearing an antistatic wrist strap and attaching it to a metal part of the system chassis. If a wrist strap is unavailable, establish and maintain contact with the system chassis throughout any procedures requiring ESD protection.

Safety Measures

To avoid damage to the system:

- Use the correct AC input voltage range.

To reduce the risk of electric shock:

- Unplug the power cord before removing the system chassis cover for installation or servicing. After installation or servicing, cover the system chassis before plugging the power cord.

About the Package

The package contains the following items. If any of these items are missing or damaged, please contact your dealer or sales representative for assistance.

- 1 AL171/AL173 motherboard
- 1 COM port cable (Length: 250mm, 1 x COM port)
- 1 Serial ATA data with power cable (Length: 300mm)

The board and accessories in the package may not come similar to the information listed above. This may differ in accordance to the sales region or models in which it was sold. For more information about the standard package in your region, please contact your dealer or sales representative.

Optional Items

- USB port cable (Length: 200mm)
- COM port cable (Length: 250mm, 1 x COM port)
- Serial ATA data with power cable (Length: 300mm)
- LPC EXT-RS232 module (4 x RS232 ports)
- LPC EXT-RS485 module (4 x RS485 ports)
- I/O shield
- Heat sink for 0 to 60°C (Height: 19mm)
- Heat sink for -40 to 85°C (Height: 32mm)

The board and accessories in the package may not come similar to the information listed above. This may differ in accordance to the sales region or models in which it was sold. For more information about the standard package in your region, please contact your dealer or sales representative.

Before Using the System Board

Before using the system board, prepare basic system components.

If you are installing the system board in a new system, you will need at least the following internal components.

- Memory module
- Storage devices such as hard disk drive, etc.

You will also need external system peripherals you intend to use which will normally include at least a keyboard, a mouse and a video display monitor.

Chapter 1 - Introduction

Specifications

SYSTEM	Processor	Intel Atom® Processor E3900 Family, BGA 1296 Intel Atom® x7-E3950 Processor, Quad Core, 2M Cache, 1.6GHz (2.0GHz), 12W Intel Atom® x5-E3940 Processor, Quad Core, 2M Cache, 1.6GHz (1.8GHz), 9.5W Intel Atom® x5-E3930 Processor, Dual Core, 2M Cache, 1.3GHz (1.8GHz), 6.5W Intel® Pentium® Processor N4200, Quad Core, 2M Cache, 1.1GHz (2.5GHz), 6W
	Memory	Two 204-pin SODIMM up to 8GB Dual Channel DDR3L 1867MHz
	BIOS	Insyde SPI 128Mbit (supports UEFI boot only)
GRAPHICS	Controller	Intel® HD Graphics GT Series
	Feature	OpenGL 5.0, DirectX 12, OpenCL 2.1 HW Decode: AVC/H.264, MPEG2, VC1/WMV9, JPEG/MJPEG, HEVC/H.265, VP8, VP9, MVC HW Encode: AVC/H.264, JPEG/MJPEG, HEVC/H.265, VP8, VP9, MVC
	Display	1 x VGA/DP++ 1 x HDMI/DP++ 1 x LVDS/eDP VGA: resolution up to 1920x1200 @ 60Hz LVDS: dual channel 48-bit, resolution up to 1920x1200 @ 60Hz HDMI: resolution up to 3840x2160 @ 30Hz DP++: resolution up to 4096x2160 @ 60Hz eDP: resolution up to 3840x2160 @ 60Hz
	Triple Displays	VGA + HDMI + LVDS VGA + HDMI + eDP DP + HDMI + LVDS DP + HDMI + eDP VGA + DP + LVDS VGA + DP + eDP DP + DP + LVDS DP + DP + eDP
EXPANSION	Interface	1 x PCIe x1 (Gen 2) 1 x M.2 B Key 1 x Full-size Mini PCIe (PCIe/USB)
AUDIO	Audio Codec	Realtek ALC888S-VD2-GR
ETHERNET	Controller	2 x Intel® I211AT/IT PCIe (10/100/1000Mbps) or 2 x Intel® I210AT/IT PCIe (10/100/1000Mbps)
REAR I/O	Ethernet	2 x GbE (RJ-45)
	USB	4 x USB 3.0
	Display	1 x HDMI/DP++ 1 x VGA/DP++
	Audio	1 x Line-out

INTERNAL I/O	Serial	2 x RS-232/422/485 (RS-232 with power) (2.0mm pitch) 4 x RS-232 (2.0mm pitch)
	USB	4 x USB 2.0 (2.0mm pitch) 1 x USB 2.0 (2.54mm pitch) or 1 x Vertical USB 2.0 (type A) (available upon request)
	Display	1 x LVDS LCD Panel Connector 1 x LCD/Inverter Power 1 x eDP LCD Panel Connector
	Audio	1 x S/PDIF 1 x Audio (Line-out/Mic-in)
	SATA	2 x SATA 3.0 (up to 6Gb/s)
	DIO	1 x 8-bit DIO
	LPC	1 x LPC (supports LPC EXT-RS232/RS485 module)
	SMBus	1 x SMBus
	WATCHDOG TIMER	Output & Interval
SECURITY	TPM	Available Upon Request
POWER	Type	Single 12V +/-10% DC (AL171) Wide Range 15~36V (AL173)
	Connector	DC-in Jack Right Angle Connector (4-pin) (available upon request) Vertical Type Connector (4-pin) (available upon request)
	RTC Battery	CR2032 Coin Cell
OS SUPPORT (UEFI ONLY)	Microsoft /Linux	Windows 10 IoT Enterprise (64-bit) Yocto Project Fedora 24 (Intel Graphics Driver available) Ubuntu 15.10 (Intel Graphics Driver available)
ENVIRONMENT	Temperature	Operating: 0 to 60°C, -40 to 85°C Storage: -40 to 85°C
	Humidity	Operating: 5 to 90% RH Storage: 5 to 90% RH
MECHANICAL	Dimensions	Mini-ITX Form Factor 170mm (6.7") x 170mm (6.7")
	Height	PCB: 1.6mm Top Side: 16.34mm Bottom Side: 3.30mm
CERTIFICATIONS		CE, FCC, RoHS

Features

• Watchdog Timer

The Watchdog Timer function allows your application to regularly “clear” the system at the set time interval. If the system hangs or fails to function, it will reset at the set time interval so that your system will continue to operate.

• DDR3L

DDR3L is a higher performance DDR3 SDRAM interface providing less voltage and higher speed successor. DDR3L SDRAM modules support 1867MHz for DDR modules. DDR3L delivers increased system bandwidth and improved performance to provide its higher bandwidth and its increase in performance at a lower power.

• Graphics

The integrated Intel® HD graphics engine delivers an excellent blend of graphics performance and features to meet business needs. It provides excellent video and 3D graphics with outstanding graphics responsiveness. These enhancements deliver the performance and compatibility needed for today's and tomorrow's business applications. Supports 1 x VGA/DP++, 1 x HDMI/DP++ and 1 x LVDS/eDP interfaces for triple display outputs.

• PCI Express

PCI Express is a high bandwidth I/O infrastructure that possesses the ability to scale speeds by forming multiple lanes. The PCI Express architecture also supports high performance graphics infrastructure by enhancing the capability of a PCIe x1.

• Serial ATA

Serial ATA is a storage interface that is compliant with SATA 1.0a specification. With speed of up to 6Gb/s (SATA 3.0), it improves hard drive performance faster than the standard parallel ATA whose data transfer rate is 100MB/s.

• Gigabit LAN

Two Intel® I211AT/IT PCI Express Gigabit Ethernet controllers or two Intel® I210AT/IT PCI Express Gigabit Ethernet controllers support up to 1Gbps data transmission.

• Audio

The Realtek ALC888S-VD2-GR audio codec provides 4-channel High Definition audio output.

• Wake-On-LAN

This feature allows the network to remotely wake up a Soft Power Down (Soft-Off) PC. It is supported via the onboard LAN port or via a PCI LAN card that uses the PCI PME (Power Management Event) signal. However, if your system is in the Suspend mode, you can power-on the system only through an IRQ or DMA interrupt.

• Wake-On-USB (optional)

This function allows you to use a USB keyboard or USB mouse to wake up a system from the S3 (STR - Suspend To RAM) state.

• ACPI STR

The system board is designed to meet the ACPI (Advanced Configuration and Power Interface) specification. ACPI has energy saving features that enables PCs to implement Power Management and Plug-and-Play with operating systems that support OS Direct Power Management. ACPI when enabled in the Power Management Setup will allow you to use the Suspend to RAM function.

With the Suspend to RAM function enabled, you can power-off the system at once by pressing the power button or selecting “Standby” when you shut down Windows® without having to go through the sometimes tiresome process of closing files, applications and operating system. This is because the system is capable of storing all programs and data files during the entire operating session into RAM (Random Access Memory) when it powers-off. The operating session will resume exactly where you left off the next time you power-on the system.

• RTC Timer

The RTC installed on the system board allows your system to automatically power-on on the set date and time.

• Power Failure Recovery

When power returns after an AC power failure, you may choose to either power-on the system manually or let the system power-on automatically.

• USB

The system board supports the new USB 3.0. It is capable of running at a maximum transmission speed of up to 5 Gbit/s (625 MB/s) and is faster than USB 2.0 (480 Mbit/s, or 60 MB/s) and USB 1.1 (12Mb/s). USB 3.0 reduces the time required for data transmission, reduces power consumption, and is backward compatible with USB 2.0. It is a marked improvement in device transfer speeds between your computer and a wide range of simultaneously accessible external Plug and Play peripherals.

Chapter 2 - Hardware Installation

Board Layout

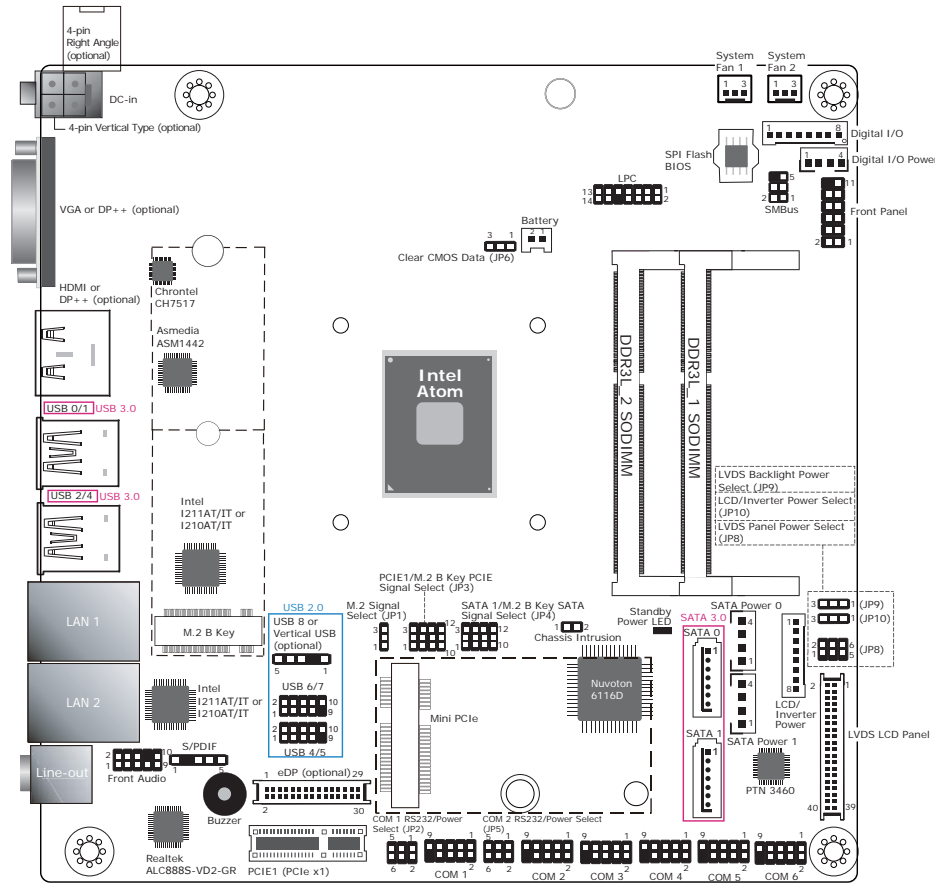

Block Diagram

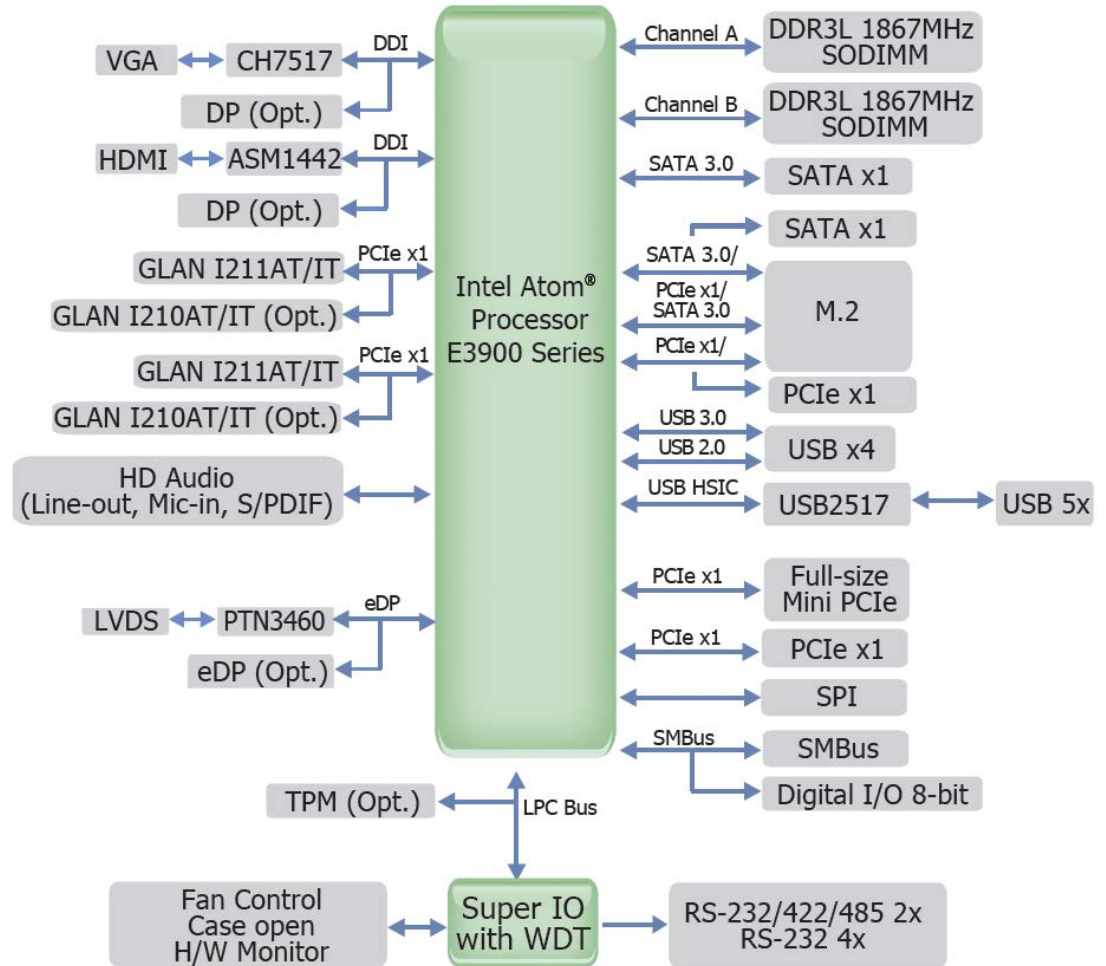

Mechanical Diagram

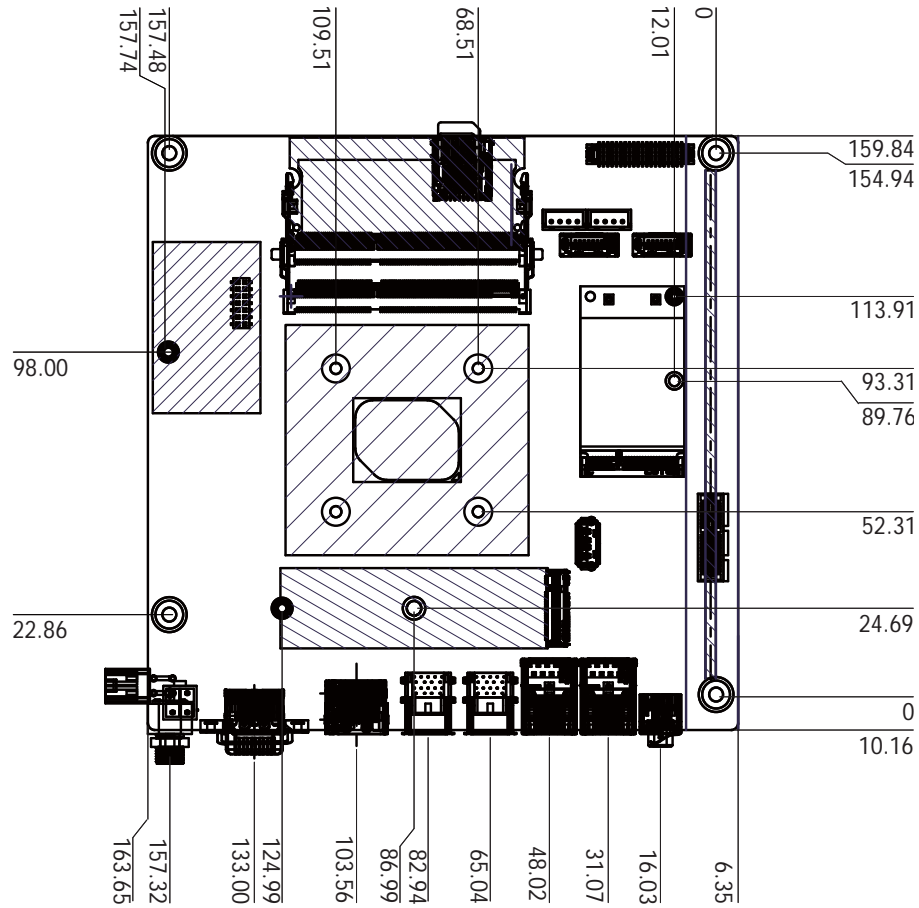

Important:

Electrostatic discharge (ESD) can damage your board, processor, disk drives, add-in boards, and other components. Perform installation procedures at an ESD workstation only. If such a station is not available, you can provide some ESD protection by wearing an antistatic wrist strap and attaching it to a metal part of the system chassis. If a wrist strap is unavailable, establish and maintain contact with the system chassis throughout any procedures requiring ESD protection.

System Memory



Important:

When the Standby Power LED lights red, it indicates that there is power on the system board. Power-off the PC then unplug the power cord prior to installing any devices. Failure to do so will cause severe damage to the motherboard and components.

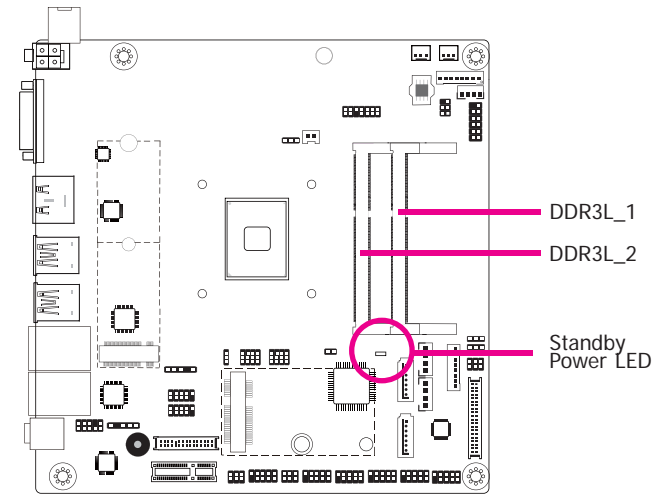

Features

- Two 204-pin SODIMM up to 8GB
- Dual Channel DDR3L 1867MHz

The system board supports the following memory interface.

Single Channel (SC)

Data will be accessed in chunks of 64 bits (8B) from the memory channels.

Dual Channel (DC)

Data will be accessed in chunks of 128 bits from the memory channels. Dual channel provides better system performance because it doubles the data transfer rate.



Important:

1. The DDR3L sockets support no mixed Row Card.
2. For dual channel population, the two channels must be populated the same DRAM density, chip width, number ranks and dimm speed.

Installing the DIMM Module



Note:

The system board used in the following illustrations may not resemble the actual board. These illustrations are for reference only.

1. Make sure the PC and all other peripheral devices connected to it has been powered down.
2. Disconnect all power cords and cables.
3. Locate the SODIMM socket on the system board.
4. Note the key on the socket. The key ensures the module can be plugged into the socket in only one direction.

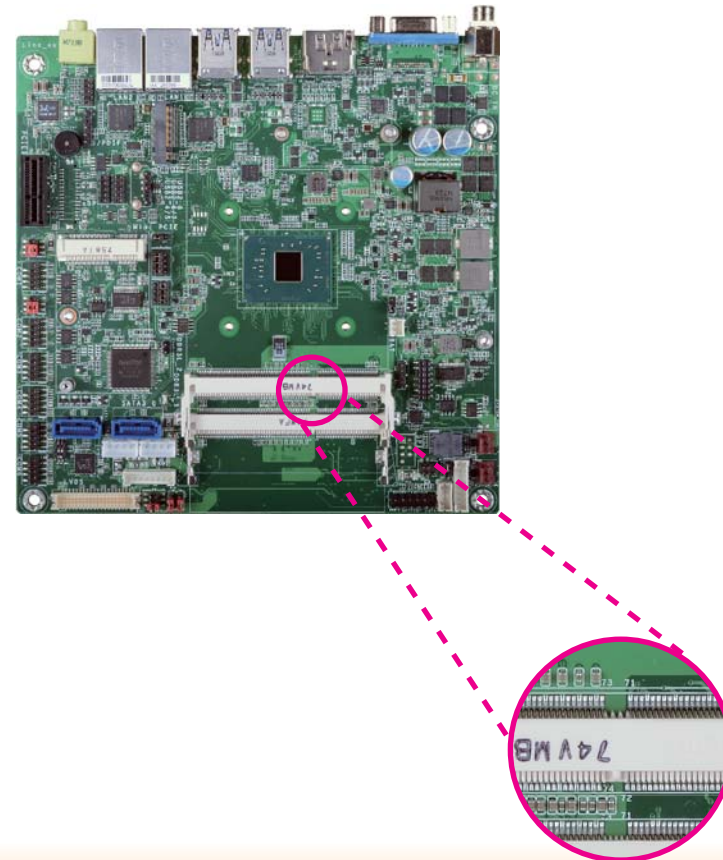

- Grasping the module by its edges, align the module into the socket at an approximately 30 degrees angle. Apply firm even pressure to each end of the module until it slips down into the socket. The contact fingers on the edge of the module will almost completely disappear inside the socket.



- Push down the module until the clips at each end of the socket lock into position. You will hear a distinctive “click”, indicating the module is correctly locked into position.

**Important:**

When installing one DDR3L SODIMM only, make sure to install it into the SODIMM 1 socket.

Installing the Heat Sink

The CPU must be kept cool by using a CPU fan with heat sink. Without sufficient air circulation across the CPU and heat sink, the CPU will overheat damaging both the CPU and system board.

- On the solder side of the board, match the retention module base to the mounting holes around the CPU socket.

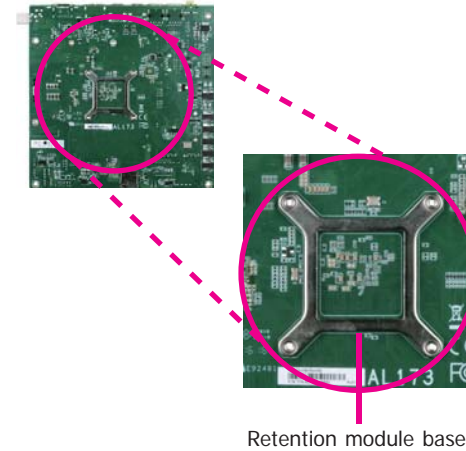

- Turn to the component side of the board making sure the retention module base is positioned and fitted properly under the board.
- Apply a thin layer of thermal paste on top of the CPU. Do not spread the paste all over the surface. When you later place the heat sink on top, the compound will disperse evenly.

- Place the heat sink assembly on top of the CPU. The 4 screws around the heat sink must match the screw holes of the retention module base. We strongly recommend using this type of heat sink assembly because it provides adequate cooling to the components of the system board.

Turn each Phillips head screw half way down first to initially stabilize the heat sink onto the board, then finally tighten each screw.



Important:

Do not turn the first screw all the way down followed by the next and so on. This is to avoid imbalance which might cause cracks or fractures to the CPU and/or heat sink assembly.

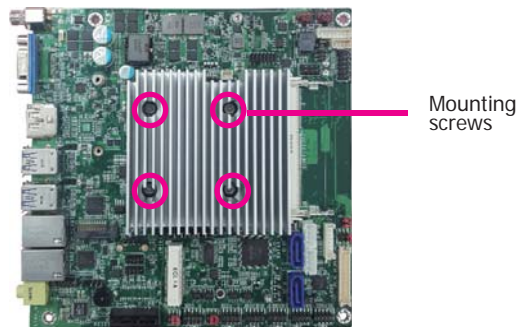
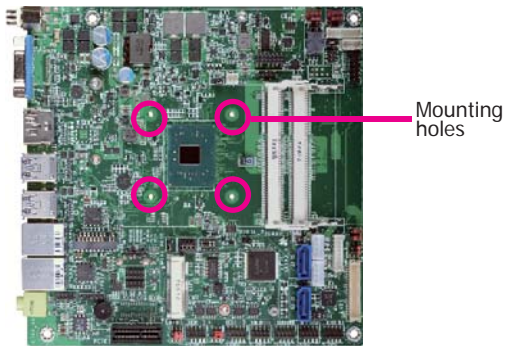

Jumper Settings

Clear CMOS Data

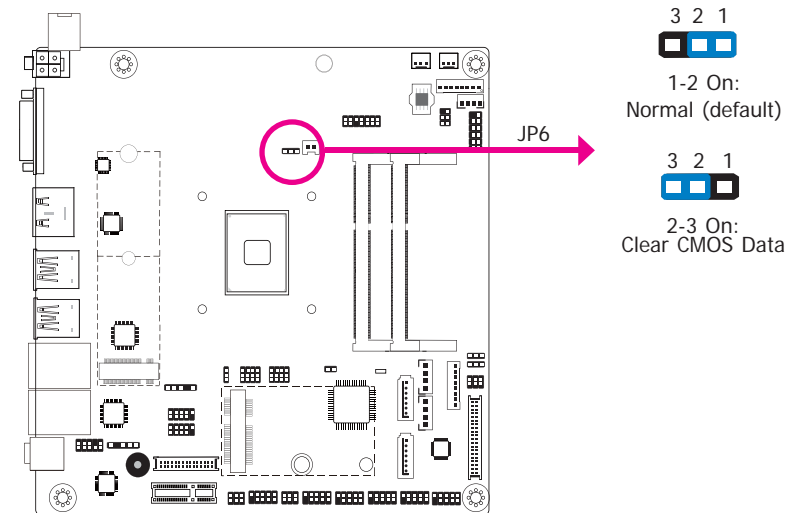

If you encounter that CMOS data becomes corrupted, you can reconfigure the system with the default values stored in the ROM BIOS.

To load the default values stored in the ROM BIOS, please follow the steps below.

- Power-off the system and unplug the power cord.
- Set JP6 pins 2 and 3 to On. Wait for a few seconds and set JP6 back to its default setting, pins 1 and 2 On.
- Now plug the power cord and power-on the system.

SATA 1/M.2 B Key SATA Signal Select

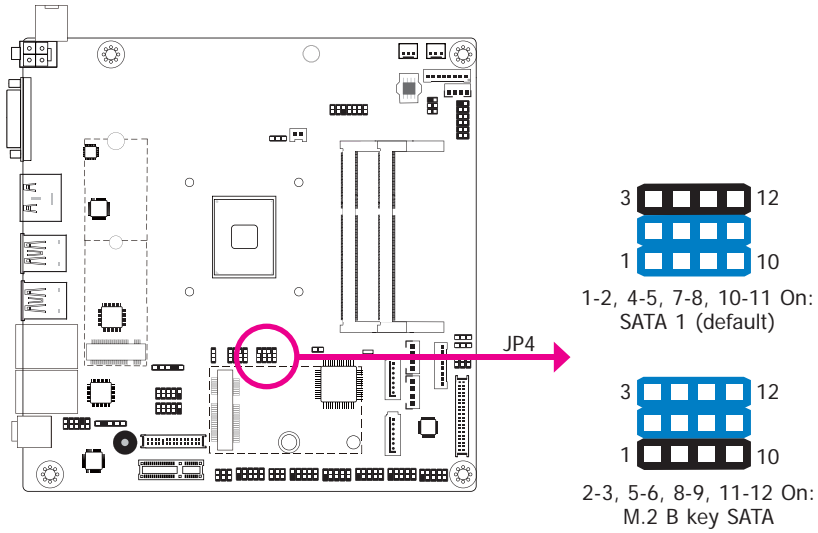

JP4 is used to select the SATA 1 (default) or M.2 B key SATA signal.

M.2 Signal Select

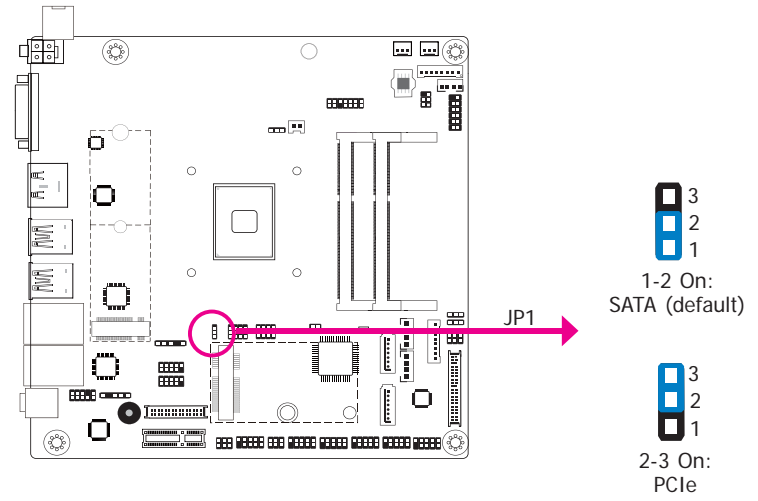

JP1 is used to select the M.2 signal: SATA (default) or PCIe.

COM1/COM2 RS232/Power Select

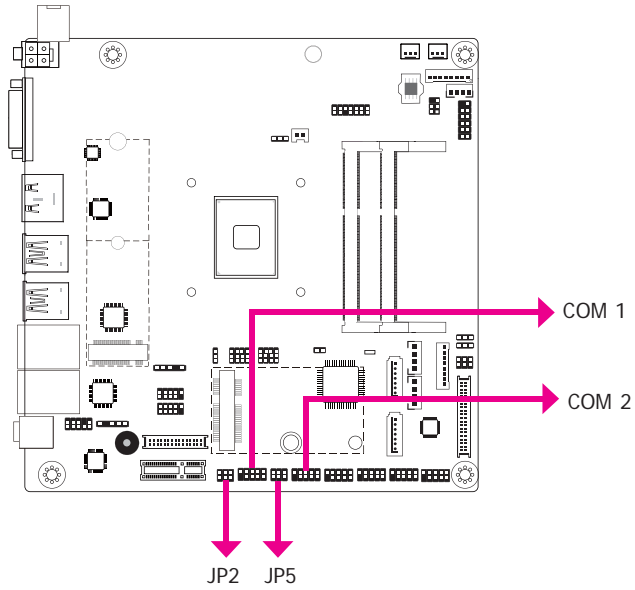

JP2 (for COM 1) and JP5 (for COM 2) are used to configure Serial COM ports to pure RS232 or RS232 with power. The pin functions of COM 1 and COM 2 will vary according to JP2's and JP5's setting respectively.

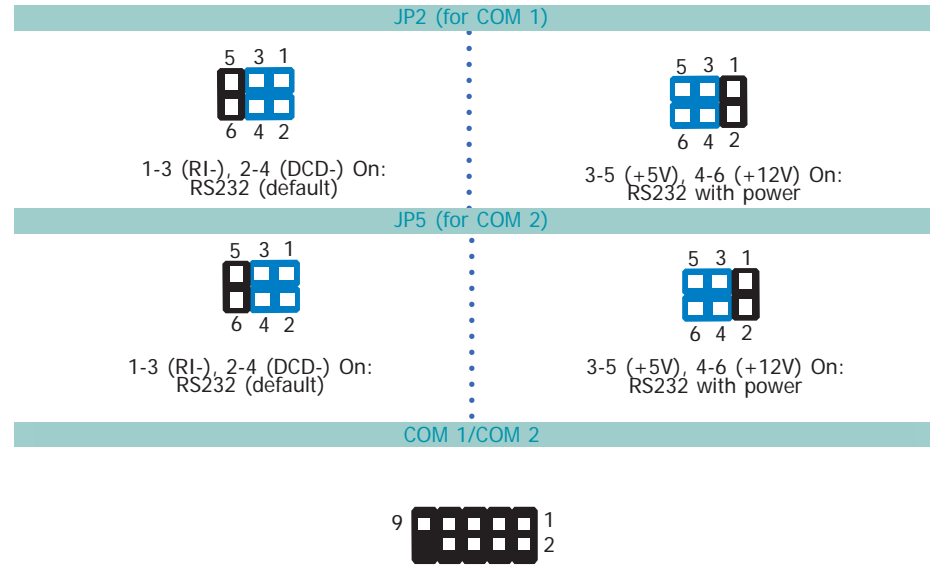

Pin	RS232	RS232 with power
1	DCD-	+12V
2	RD	RD
3	TD	TD
4	DTR-	DTR-
5	GND	GND
6	DSR-	DSR-
7	RTS-	RTS-
8	CTS-	CTS-
9	RI-	+5V

LCD/Inverter Power Select

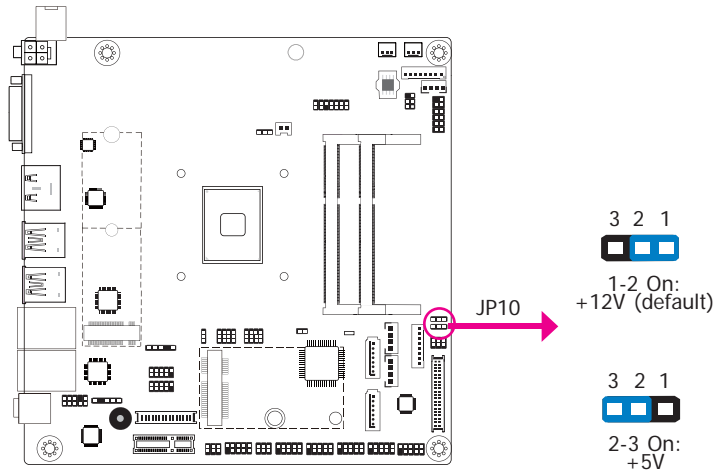

JP10 is used to select the power level of LVDS LCD inverter connector.

Backlight Power Select

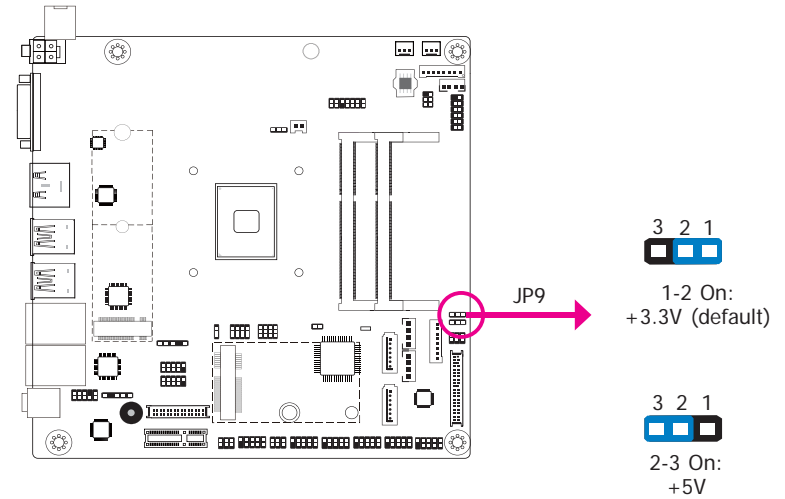

JP9 is used to select the power level of backlight brightness control: +3.3V or +5V.

Panel Power Select

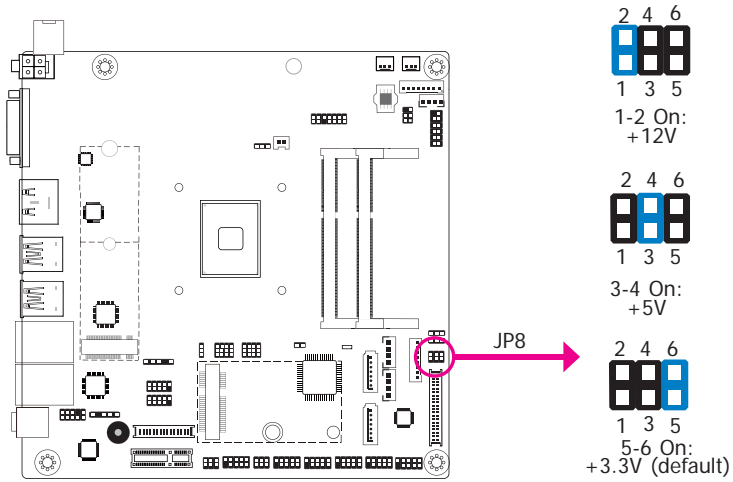

JP8 is used to select the power supplied with the LCD panel.



Important:

Before powering-on the system, make sure that the power settings of JP8 match the LCD panel's specification. Selecting the incorrect voltage will seriously damage the LCD panel.

PCIe1/M.2 B Key PCIe Signal Select

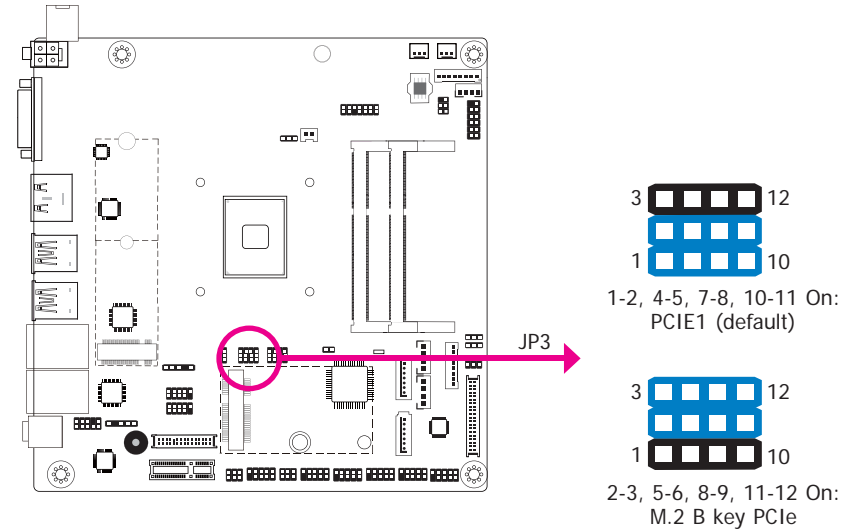

JP3 is used to select the PCIe1 (default) or M.2 B key PCIe signal.

Rear Panel I/O Ports



The rear panel I/O ports consist of the following:

- 1 DC-in
- 1 VGA (default) or DP++ (optional)
- 1 HDMI (default) or DP++ (optional)
- 4 USB 3.0
- 2 GbE (RJ-45)
- 1 Line-out

12V DC-in (AL171)/15~36V (AL173)

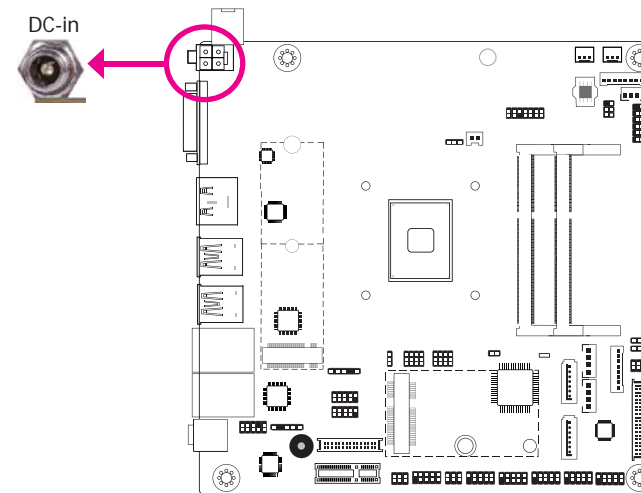

This jack is considered a low power solution. Connect a DC power cord to this jack. Using a voltage more than the recommended range may fail to boot the system or cause damage to the system board.

The DC-in jack on the system board co-lays with a 4-pin right angle connector (optional) or 4-pin vertical type connector (optional) as the photo displayed below.



Graphics Interface

The display ports consist of the following:

- 1 VGA (default) or DP++ (optional)
- 1 HDMI (default) or DP++ (optional)

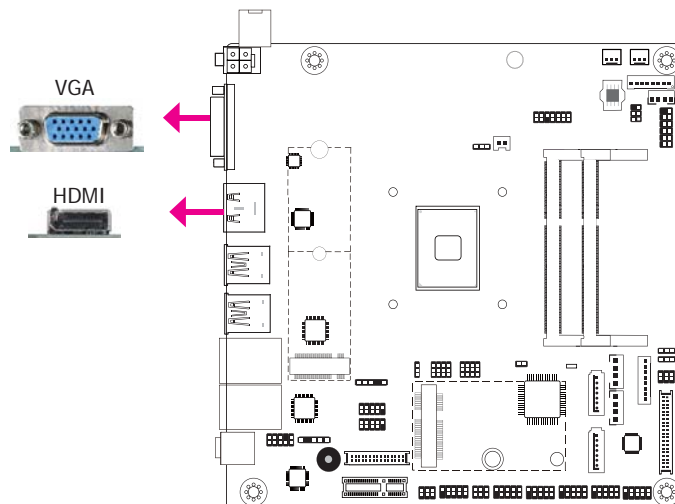

VGA Port

The VGA port is used for connecting a VGA monitor. Connect the monitor's 15-pin D-shell cable connector to the VGA port. After you plug the monitor's cable connector into the VGA port, gently tighten the cable screws to hold the connector in place.

DisplayPort

The DisplayPort is a digital display interface used to connect a display device such as a computer monitor. It is used to transmit audio and video simultaneously. The interface, which is developed by VESA, delivers higher performance features than any other digital interface.

HDMI Port

The HDMI port which carries both digital audio and video signals is used to connect a LCD monitor or digital TV that has the HDMI port.

Driver Installation

Install the graphics driver. Refer to chapter 4 for more information.

RJ45 LAN Ports

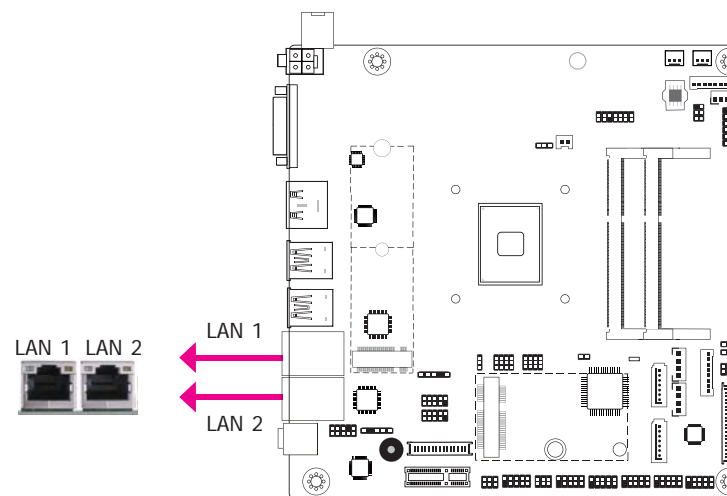

Features

- Two Intel® I211AT/IT PCI Express Gigabit Ethernet controllers or two Intel® I210AT/IT PCI Express Gigabit Ethernet controllers

The two LAN ports allow the system board to connect to a local area network by means of a network hub.

BIOS Setting

Configure the onboard LAN ports in the Advanced menu ("ACPI Configuration" submenu) of the BIOS. Refer to the chapter 3 for more information.

Driver Installation

Install the LAN drivers. Refer to the chapter 4 for more information.

USB Ports

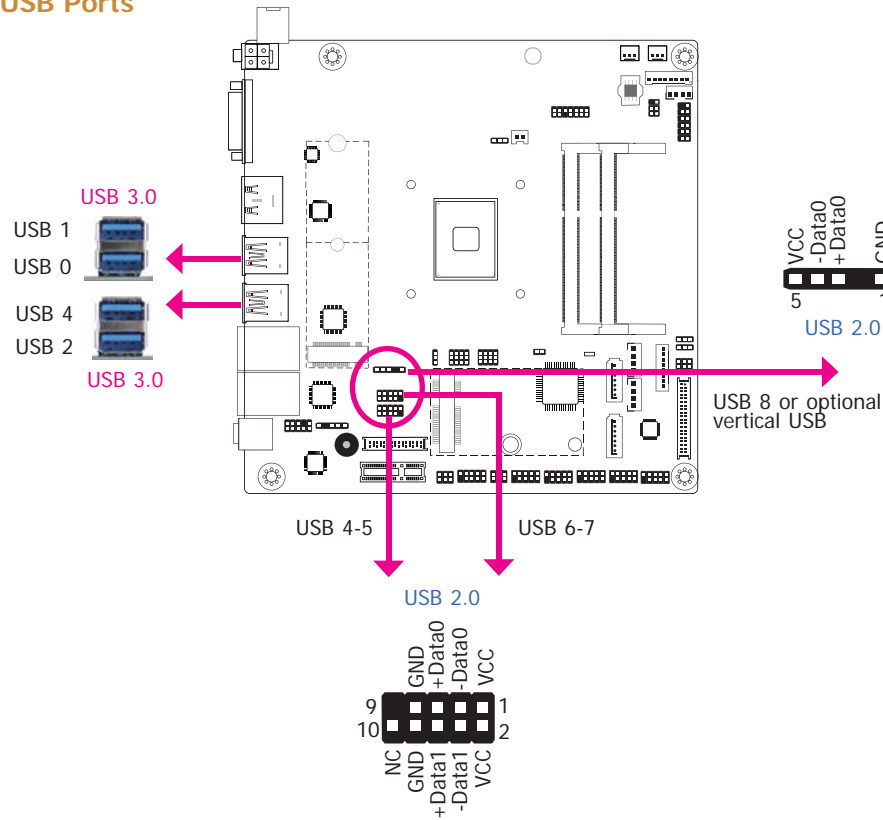

The USB device allows data exchange between your computer and a wide range of simultaneously accessible external Plug and Play peripherals.

The system board is equipped with four onboard USB 3.0 ports (USB 0-1/2-4) at the rear panel I/O ports. The 10-pin connectors allow you to connect 4 additional USB 2.0 ports (USB 4-5/6-7). The 5-pin connector allows you to connect 1 additional USB 2.0 port (USB 8). The additional USB ports may be mounted on a card-edge bracket. Install the card-edge bracket to an available slot at the rear of the system chassis and then insert the USB port cables to a connector.

Wake-On-USB Keyboard/Mouse (optional)

The Wake-On-USB Keyboard/Mouse function allows you to use a USB keyboard or USB mouse to wake up a system from the S3 (STR - Suspend To RAM) state.

Audio

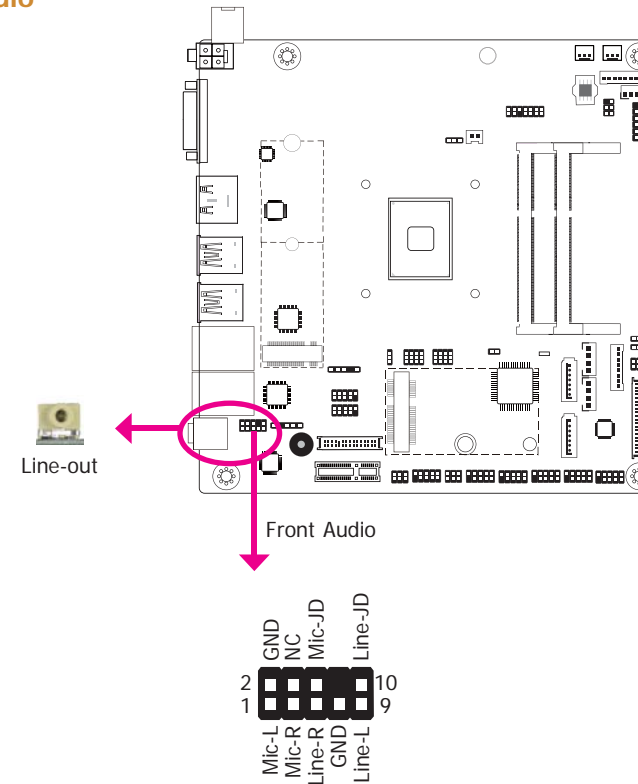

Rear Audio

The system board is equipped with 1 audio jack. This jack is a one-hole connecting interface for inserting a plug.

- Line-out Jack (Lime)
This jack is used to connect a headphone or external speakers.

Front Audio

The front audio connector allows you to connect to the second line-out and mic-in jacks that are at the front panel of your system.

BIOS Setting

Configure these onboard Audio devices in the Advanced menu ("Audio Configuration" sub-menu) of the BIOS. Refer to the chapter 3 for more information.

Driver Installation

Install the audio driver. Refer to the chapter 4 for more information.

I/O Connectors

SATA (Serial ATA) Connectors

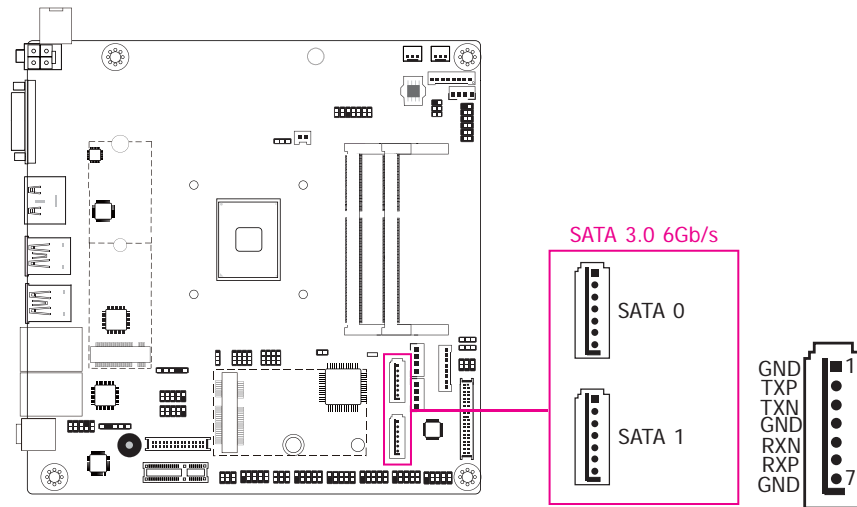

Features

- 2 Serial ATA 3.0 ports with data transfer rate up to 6Gb/s (SATA 0 and SATA 1)
- Integrated Advanced Host Controller Interface (AHCI) controller

The Serial ATA connectors are used to connect Serial ATA devices. Connect one end of the Serial ATA data cable to a SATA connector and the other end to your Serial ATA device.

BIOS Setting

Configure the Serial ATA drives in the Advanced menu ("SATA Configuration" submenu) of the BIOS. Refer to the chapter 3 for more information.

SATA (Serial ATA) Power Connectors

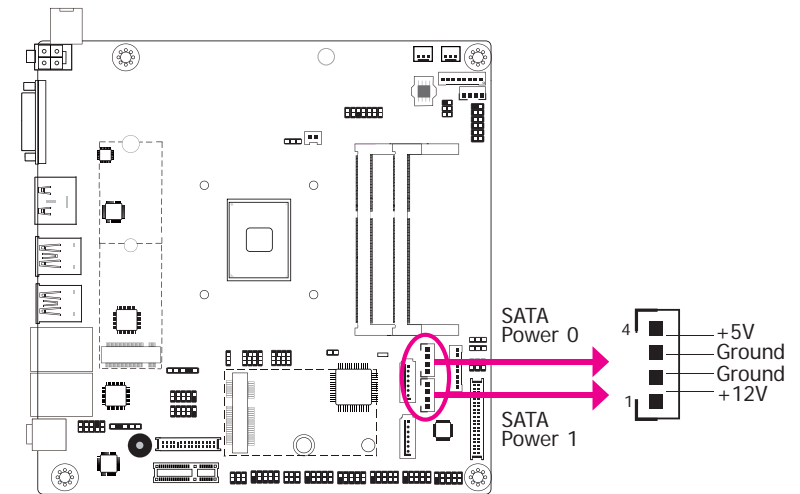

The SATA power connectors supply power to the SATA drive. Connect one end of the provided power cable to the SATA power connector and the other end to your storage device.

S/PDIF Connector

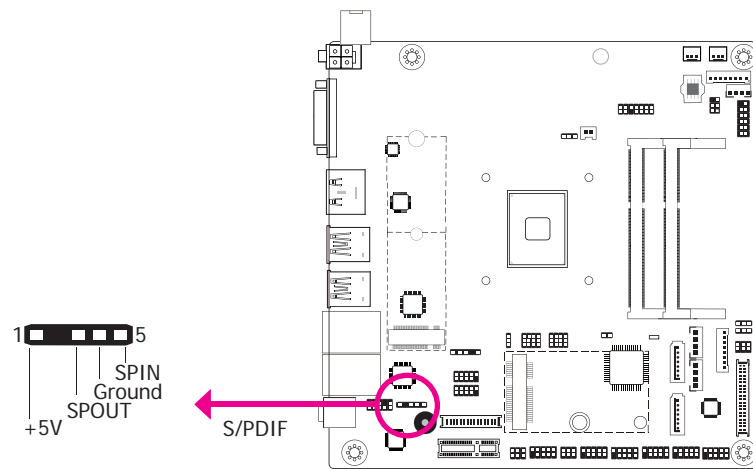

The S/PDIF connector is used to connect an external S/PDIF port. Your S/PDIF port may be mounted on a card-edge bracket. Install the card-edge bracket to an available slot at the rear of the system chassis then connect the audio cable to the S/PDIF connector. Make sure pin 1 of the audio cable is aligned with pin 1 of the S/PDIF connector.

Digital I/O and Power Connectors

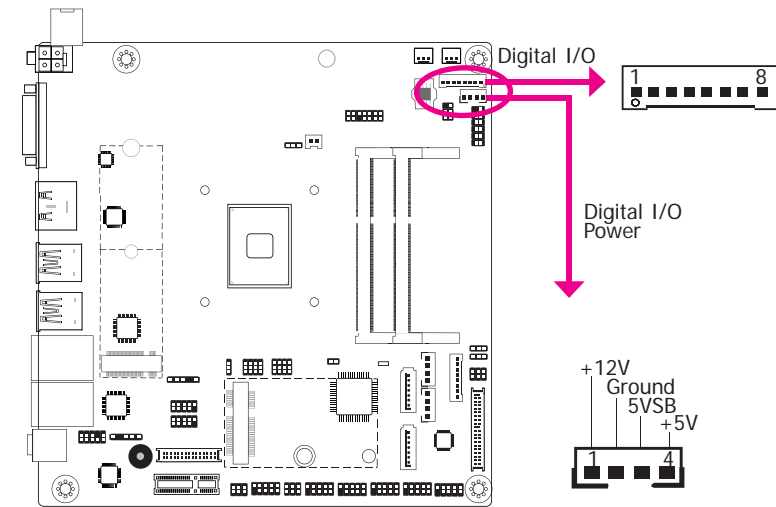

The 8-bit Digital I/O connector provides powering-on function to external devices that are connected to these connectors. The pin functions of the 8-bit digital I/O connector are listed below.

Digital I/O Connector

Pin	Function
1	DIO7
2	DIO6
3	DIO5
4	DIO4
5	DIO3
6	DIO2
7	DIO1
8	DIO0

Cooling Fan Connectors

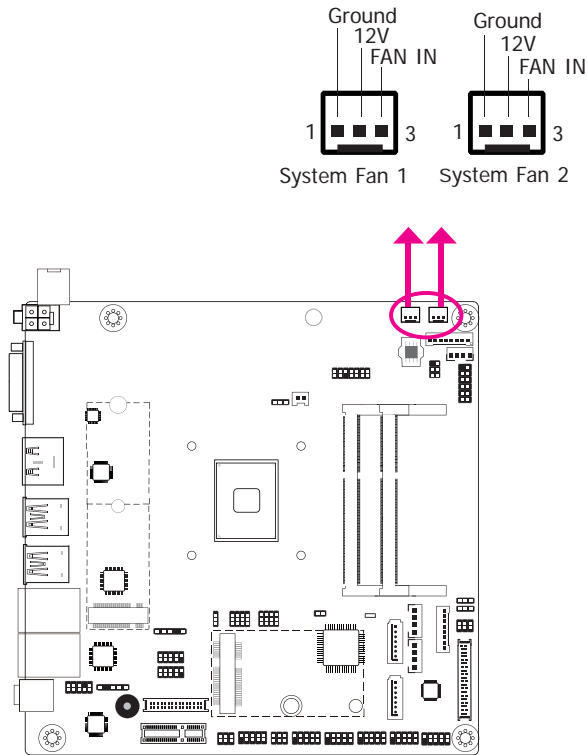

The fan connectors are used to connect cooling fans. The cooling fans will provide adequate airflow throughout the chassis to prevent overheating the CPU and system board components.

BIOS Setting

The Advanced menu (“SIO NUVOTON6116D” submenu) of the BIOS will display the current speed of the cooling fans. Refer to the chapter 3 for more information.

Front Panel Connector

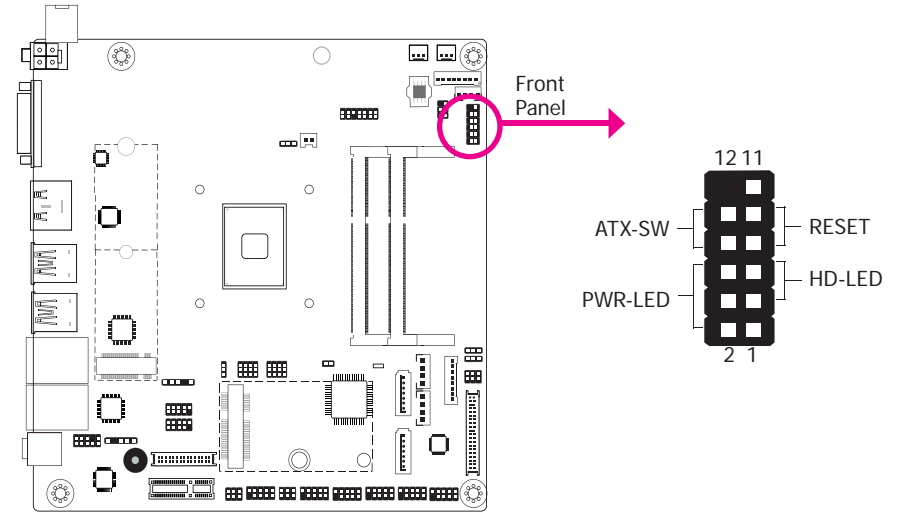

HD-LED - Hard Drive LED

This LED will light when the hard drive is being accessed.

RESET - Reset Switch

This switch allows you to reboot without having to power off the system.

ATX-SW - Power Switch

This switch is used to power on or off the system.

PWR-LED - Power/Standby LED

When the system's power is on, this LED will light. When the system is in the S1 (POS - Power On Suspend) state, it will blink every second. When the system is in the S3 (STR - Suspend To RAM) state, it will blink every 4 seconds.

	Pin	Function		Pin	Function
HD-LED	3	3V3	PWR-LED	2	3V3SB
	5	HDD_LED		4	3V3SB
RESET	7	GND	ATX-SW	6	Power_LED
	9	Reset		8	GND
	11	NC		10	Power_Button

COM (Serial) Ports

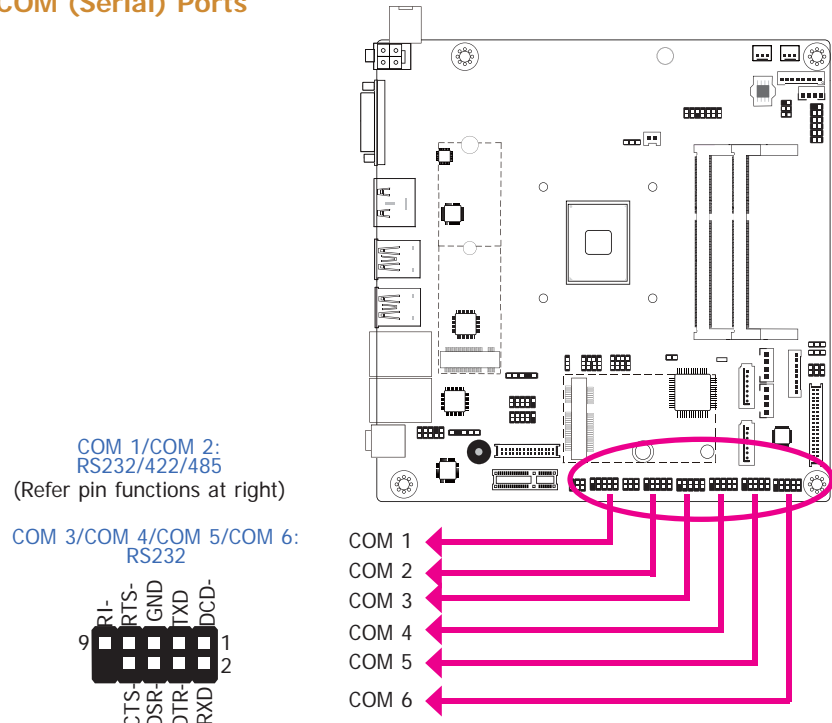

COM 1 and COM 2 can be selected among RS232, RS422 and RS485. COM 3 to COM 6 are fixed at RS232.

The pin functions of COM 1 and COM 2 ports will vary according to JP2's and JP5's setting respectively. JP2 and JP5 are used respectively to configure the Serial COM port 1 and the Serial COM port 2 to pure RS232 or RS232 with power. Refer to "COM 1/COM 2 RS232/Power Select" in this chapter for more information.

The serial ports are asynchronous communication ports with 16C550A-compatible UARTs that can be used with modems, serial printers, remote display terminals, and other serial devices.

Connecting External Serial Ports

Your COM port may come mounted on a card-edge bracket. Install the card-edge bracket to an available slot at the rear of the system chassis then insert the serial port cable to the COM connector. Make sure the colored stripe on the ribbon cable is aligned with pin 1 of the COM connector.

BIOS Setting

Configure the serial COM ports in the Advanced menu ("SIO NUVOTON6116D" submenu) of the BIOS. Refer to the chapter 3 for more information.

COM 1/COM 2 Port Connectors

Pin	RS232	RS422 (Full Duplex)	RS485
1	DCD-	RXD+	DATA+
2	RXD	RXD-	DATA-
3	TXD	TXD+	NC
4	DTR-	TXD-	NC
5	GND	GND	GND
6	DSR-	NC	NC
7	RTS-	NC	NC
8	CTS-	NC	NC
9	RI-	NC	NC



Note:

If you need to install the serial port cables and PCIe card, it will be easier to install the serial port cables first.

LVDS LCD Panel Connector

LCD/Inverter Power Connector

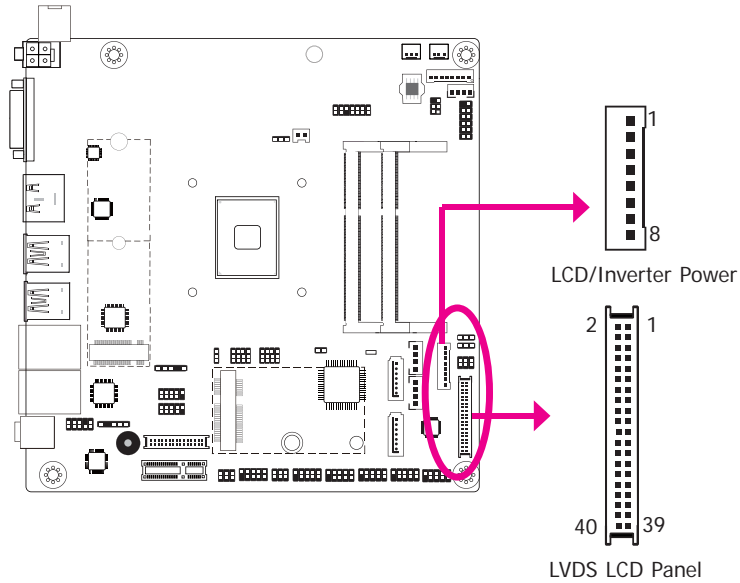

The system board allows you to connect a LCD Display Panel by means of the LVDS LCD panel connectors and the LCD/Inverter power connectors. These connectors transmit video signals and power from the system board to the LCD Display Panel.

Refer to the right side for the pin functions of these connectors.

Jumper Settings

Refer to the “Jumper Settings” section in this chapter for settings relevant to the LCD panel.

BIOS Setting

Configure the LCD panel in the Advanced menu (“Video Configuration” sub-menu) of the BIOS. Refer to chapter 3 for more information.

LVDS LCD Panel Connector

Pin	Function	Pin	Function
1	GND	2	GND
3	LVDS_Out3+	4	LVDS_Out7+
5	LVDS_Out3-	6	LVDS_Out7-
7	GND	8	GND
9	LVDS_Out2+	10	LVDS_Out6+
11	LVDS_Out2-	12	LVDS_Out6-
13	GND	14	GND
15	LVDS_Out1+	16	LVDS_Out5+
17	LVDS_Out1-	18	LVDS_Out5-
19	GND	20	GND
21	LVDS_Out0+	22	LVDS_Out4+
23	LVDS_Out0-	24	LVDS_Out4-
25	GND	26	GND
27	LVDS_CLK1+	28	LVDS_CLK2+
29	LVDS_CLK1-	30	LVDS_CLK2-
31	GND	32	GND
33	DDC_CLK	34	NC
35	DDC_DATA	36	3.3V
37	Panel Power	38	Panel Power
39	Panel Power	40	Panel Power

LCD/Inverter Power Connector

Pin	Function
1	GND
2	GND
3	Panel Inverter Brightness Voltage Control
4	Panel Power
5	+3.3V
6	Panel Backlight On/Off Control
7	+12V (default)/+5V
8	+12V (default)/+5V



Note:

DFI board's LVDS connector: Hirose DF13-40DP-1.25V(91)/40P/1.25mm; cable side connector: Hirose DF13-40DS-1.25C.

SMBus Connector

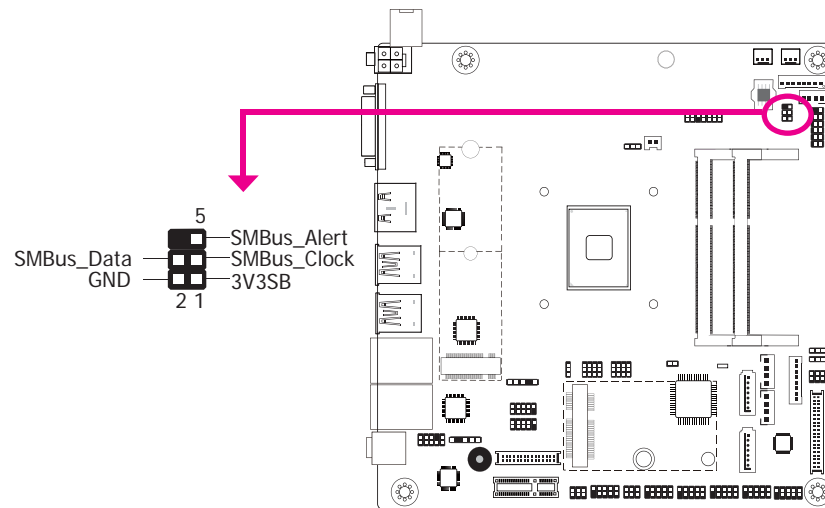

The SMBus (System Management Bus) connector is used to connect SMBus devices. It is a multiple device bus that allows multiple chips to connect to the same bus and enable each one to act as a master by initiating data transfer.

Standby Power LED

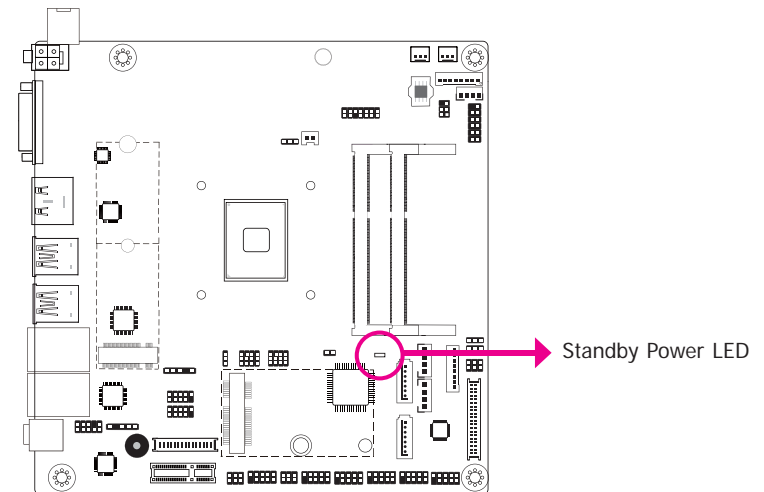

This LED will lit red when the system is in the standby mode. It indicates that there is power on the system board. Power-off the PC and then unplug the power cord prior to installing any devices. Failure to do so will cause severe damage to the motherboard and components.

Chassis Intrusion Connector

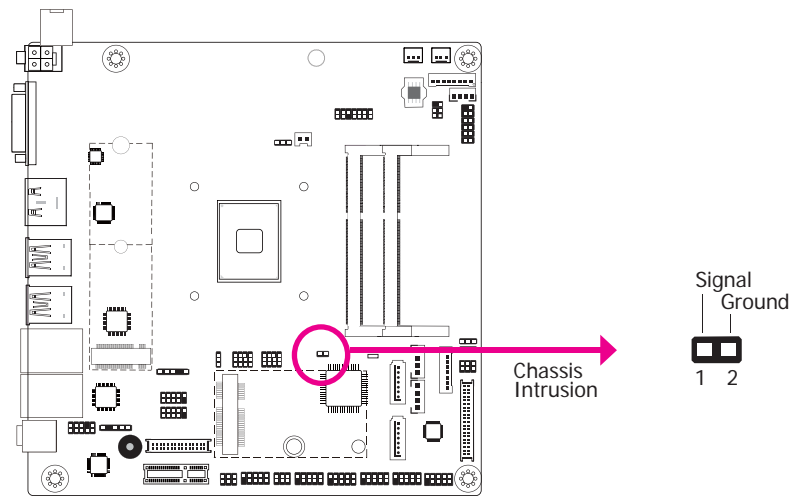

The board supports the chassis intrusion detection function. Connect the chassis intrusion sensor cable from the chassis to this connector. When the system's power is on and a chassis intrusion occurred, an alarm will sound. When the system's power is off and a chassis intrusion occurred, the alarm will sound only when the system restarts.

BIOS Setting

Configure the chassis intrusion detection function in the Advanced menu ("SIO NUVO-TON6116D" submenu) of the BIOS. Refer to the chapter 3 for more information.

Expansion Slots

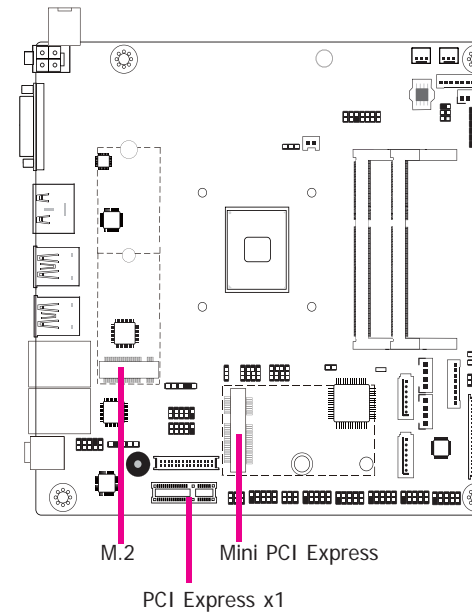

M.2 (B key) Socket

The M.2 socket is the Next Generation Form Factor (NGFF) which is designed to support multiple modules and make the M.2 more suitable in application for solid-state storage.

PCI Express x1 Slot

Install PCI Express cards such as network cards or other cards that comply to the PCI Express specifications into the PCI Express x1 slot.

Mini PCI Express Slot

The Mini PCIe socket is used to install a Mini PCIe card. Mini PCIe card is a small form factor PCI card with the same signal protocol, electrical definitions, and configuration definitions as the conventional PCI.



Note:

If you need to install the serial port cables and PCIe card, it will be easier to install the serial port cables first.

LPC Connector

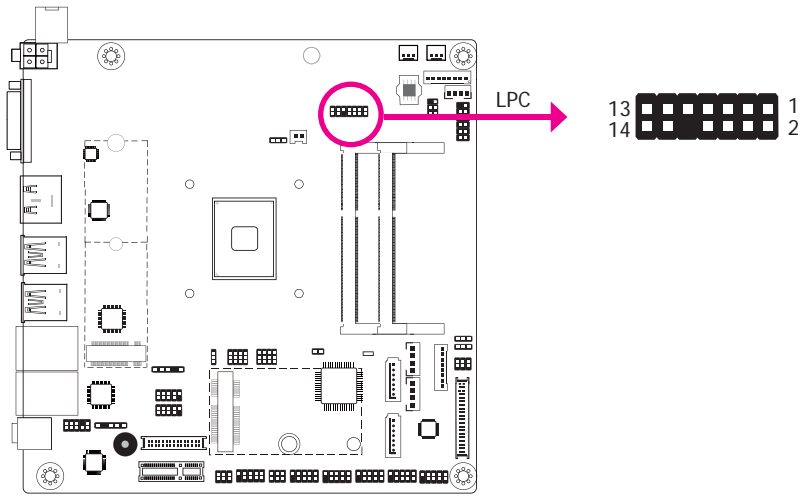

The LPC connector is used for the debug function and its pin functions are listed below.

Pin	Function	Pin	Function
1	L_CLK	2	L_AD1
3	L_RST#	4	L_AD0
5	L_FRAME#	6	3.3V
7	L_AD3	8	GND
9	L_AD2	10	---
11	INT_SERIRQ	12	GND
13	5VSB	14	5V

Connecting the EXT-RS232/RS485 Card to the Motherboard

With DFI's proprietary technology, AL171/173 supports two extension modules for additional four COM ports. The EXT-RS232/RS485 card is connected to AL171/173 via the LPC connector. The illustrations below guide you how to connect the extension module to the motherboard.

Note:
The system board used in the following illustrations may not resemble the actual one. These illustrations are for reference only.

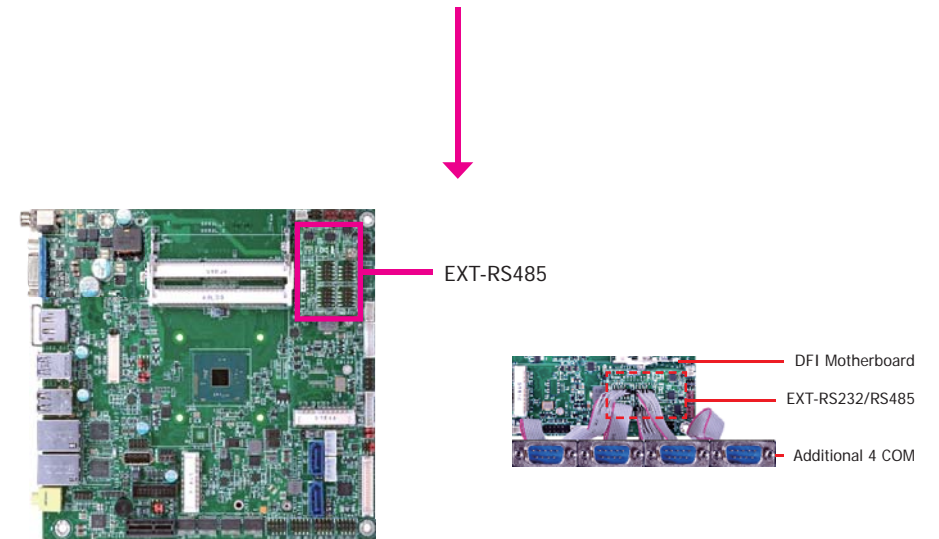
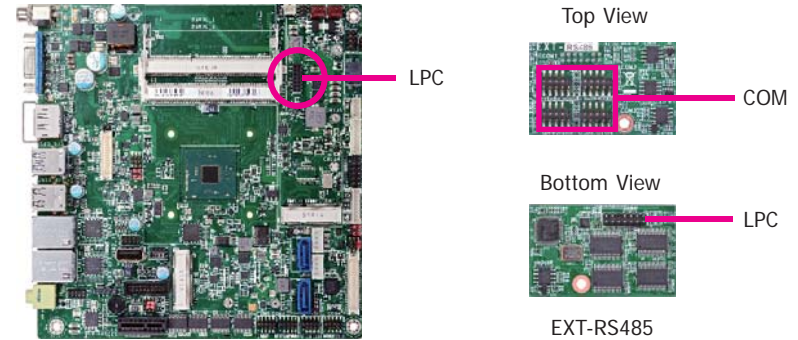

eDP Connector (optional)

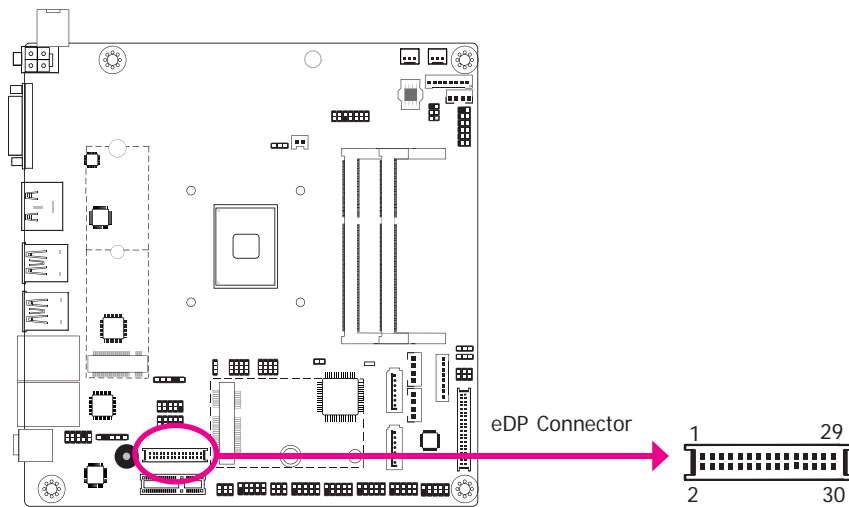

The eDP connector is an embedded displayport which has advanced power-saving features to connect a display device to transmit digital communication of audio and video signals. The table on the right indicates the pin functions of the eDP connector.

eDP Connector

Pin	Function	Pin	Function
1	GND	2	GND
3	ML_Lane 0-	4	ML_Lane 3-
5	ML_Lane 0+	6	ML_Lane 3+
7	GND	8	NC
9	ML_Lane 1-	10	GND
11	ML_Lane 1+	12	AUX-
13	GND	14	AUX+
15	ML_Lane 2-	16	GND
17	ML_Lane 2+	18	Hot Plug
19	+V_LCD	20	+V_LCD
21	GND	22	GND
23	Panel Backlight On/Off Control	24	Panel Inverter Brightness Voltage Control
25	Inverter GND	26	Inverter GND
27	3V3	28	Inverter PWR
29	Inverter PWR	30	Inverter PWR

Battery

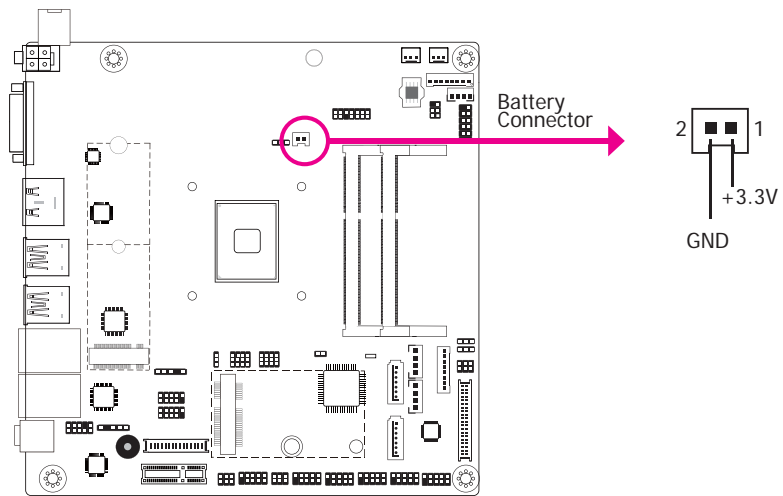

The lithium ion battery powers the real-time clock and CMOS memory. It is an auxiliary source of power when the main power is shut off.

Safety Measures

- Danger of explosion if battery incorrectly replaced.
- Replace only with the same or equivalent type recommended by the manufacturer.
- Dispose of used batteries according to local ordinance.

Chapter 3 - BIOS Setup

Overview

The BIOS is a program that takes care of the basic level of communication between the CPU and peripherals. It contains codes for various advanced features found in this system board. The BIOS allows you to configure the system and save the configuration in a battery-backed CMOS so that the data retains even when the power is off. In general, the information stored in the CMOS RAM of the EEPROM will stay unchanged unless a configuration change has been made such as a hard drive replaced or a device added.

It is possible that the CMOS battery will fail causing CMOS data loss. If this happens, you need to install a new CMOS battery and reconfigure the BIOS settings.

Note:

The BIOS is constantly updated to improve the performance of the system board; therefore the BIOS screens in this chapter may not appear the same as the actual one. These screens are for reference purpose only.

Default Configuration

Most of the configuration settings are either predefined according to the Load Optimal Defaults settings which are stored in the BIOS or are automatically detected and configured without requiring any actions. There are a few settings that you may need to change depending on your system configuration.

Entering the BIOS Setup Utility

The BIOS Setup Utility can only be operated from the keyboard and all commands are keyboard commands. The commands are available at the right side of each setup screen.

The BIOS Setup Utility does not require an operating system to run. After you power up the system, the BIOS message appears on the screen and the memory count begins. After the memory test, the message "Press DEL to run setup" will appear on the screen. If the message disappears before you respond, restart the system or press the "Reset" button. You may also restart the system by pressing the <Ctrl> <Alt> and keys simultaneously.

Legends

Keys	Function
Right and Left arrows	Moves the highlight left or right to select a menu.
Up and Down arrows	Moves the highlight up or down between submenu or fields.
<Esc>	Exit to the BIOS Setup Utility.
<F1>	Help
<F5>	Change values
<F6>	Change values
<F9>	Setup Defaults
<F10>	Save and Exit
<Enter>	Press <Enter> to enter the highlighted submenu.

Scroll Bar

When a scroll bar appears to the right of the setup screen, it indicates that there are more available fields not shown on the screen. Use the up and down arrow keys to scroll through all the available fields.

Submenu

When "►" appears on the left of a particular field, it indicates that a submenu which contains additional options are available for that field. To display the submenu, move the highlight to that field and press <Enter>.

Insyde BIOS Setup Utility

Main

The Main menu is the first screen that you will see when you enter the BIOS Setup Utility.

InsydeH2O Setup Utility		Rev. 5.0
Main	Advanced	Security Boot Exit
Project Name	AL17x	This is the help for the hour, minute, second field. Valid range is from 0 to 23, 0 to 59, 0 to 59. INCREASE/REDUCE: +/-.
BIOS Version	B183.09A	
Intel(R) Atom(TM) Processor E3930 @ 1.30GHz		
CPU Speed	1300 MHz	
CPUID	0x506C9	
L1 Data Cache	24 KB	
L1 Instruction Cache	32 KB	
L2 Cache	1024 KB	
L3 Cache	0 KB	
Number Of Processors	2 Core(s) / 2 Thread(s)	
BXT SOC	B1 Stepping	
Microcode Rev	0000002E	
Total Memory	4096 MB	
System Memory Speed	1600 MHz	
SODIMM 0	4096 MB	
SODIMM 1	[Not Installed]	
TXE FW Version	3. 1. 50. 2222	
System Time	[04:23:48]	
System Date	[09/21/2095]	

F1 Help	↑/↓ Select Item	F5/F6 Change Values	F9 Setup Defaults
Esc Exit	←/→ Select Item	Enter Select ► SubMenu	F10 Save and Exit

System Time

The time format is <hour>, <minute>, <second>. The time is based on the 24-hour military-time clock. For example, 1 p.m. is 13:00:00. Hour displays hours from 00 to 23. Minute displays minutes from 00 to 59. Second displays seconds from 00 to 59.

System Date

The date format is <month>, <date>, <year>. Month displays the month, from 01 to 12. Date displays the date, from 01 to 31. Year displays the year, from 2000 to 2099.

Advanced

The Advanced menu allows you to configure your system for basic operation. Some entries are defaults required by the system board, while others, if enabled, will improve the performance of your system or let you set some features according to your preference.



Important:

Setting incorrect field values may cause the system to malfunction.

InsydeH2O Setup Utility		Rev. 5.0
Main	Advanced	Security Boot Exit
<ul style="list-style-type: none"> ▶ACPI Configuration ▶CPU Configuration ▶Video Configuration ▶Audio Configuration ▶SATA Configuration ▶PCI Express Configuration ▶Console Redirection ▶SIO NUVOTON6116D 		ACPI Configuration Setting

F1 Help	↑/↓ Select Item	F5/F6 Change Values	F9 Setup Defaults
Esc Exit	←/→ Select Item	Enter Select ► SubMenu	F10 Save and Exit

ACPI Configuration

This section configures the system ACPI parameters.

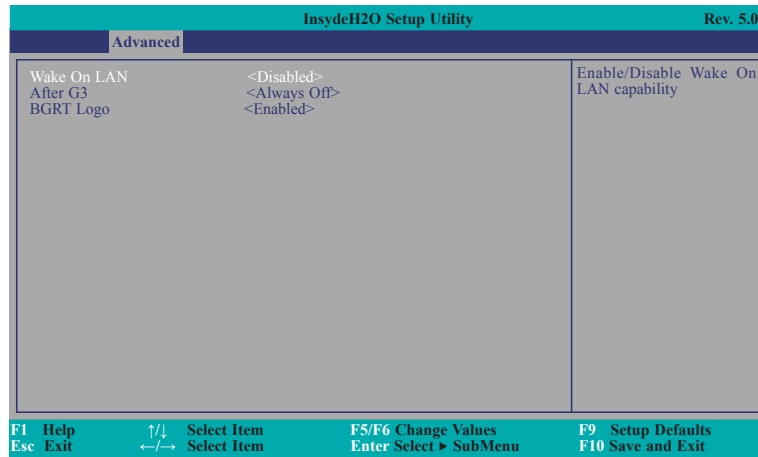

Wake On LAN

Enable or Disable this field to use the LAN signal to wake up the system.

After G3

This field is to specify what state the system should be in when power is re-applied after a power failure (G3, the mechanical-off, state).

Always On The system is in working state.

Always Off The system is in soft-off state, except for trickle current to devices such as the power button.

BGRT Logo

This field only appears when Quiet Boot of Boot menu is set to enabled. Use this field to enable or disable the display of an operating system logo or image during boot using the BGRT (Boot Graphics Resource Table) mechanism.

CPU Configuration

This section configures the CPU.

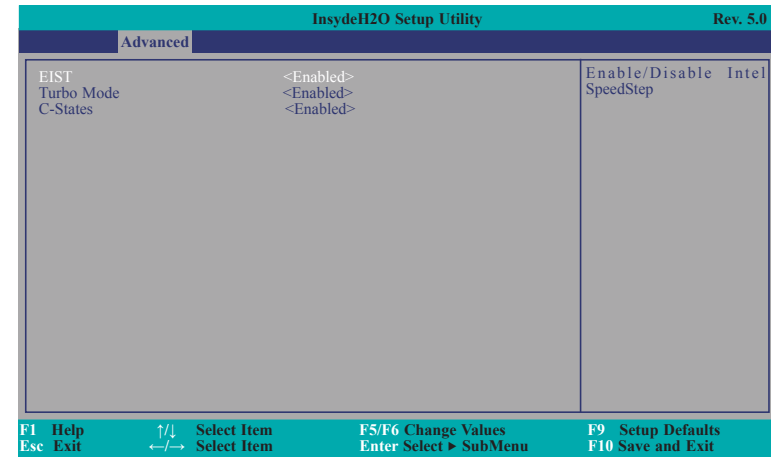

EIST

This field is used to enable or disable the Enhanced Intel SpeedStep® Technology, which helps optimize the balance between system's power consumption and performance. After it is enabled in the BIOS, you can enable the EIST feature using the operating system's power management.

Turbo Mode

This field is used to enable or disable processor turbo mode (requires that EMTTM is enabled too), which allows the processor core to automatically run faster than the base frequency when the processor's power, temperature, and specification are within the limits of TDP.

C-States

Enable or disable CPU Power Management. It allows CPU to go to C States when it's not 100% utilized.

Video Configuration

This section configures the video settings.

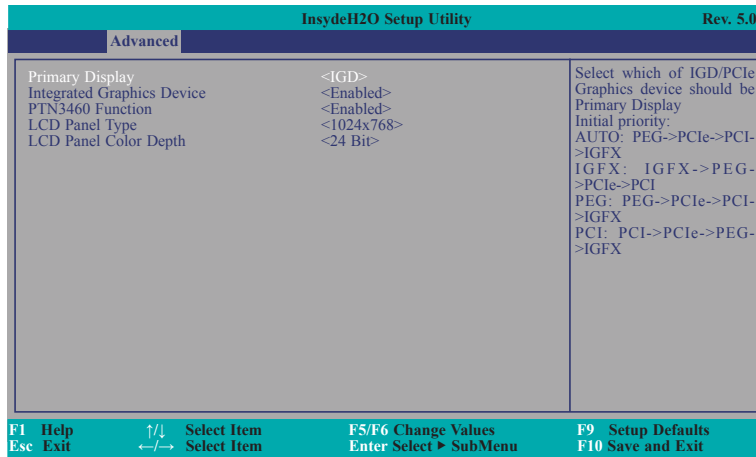

Primary Display

Select either IGD or PCIe Graphics device to be the primary display.

Integrated Graphics Device

Keep IGD enabled or disabled based on the setup options.

PTN3460 Function

Enable or disable PTN3460 LCD Features.

LCD Panel Type

Select the type of LCD panel connected to the system's LCD connector. Please check the specifications of your LCD monitor.

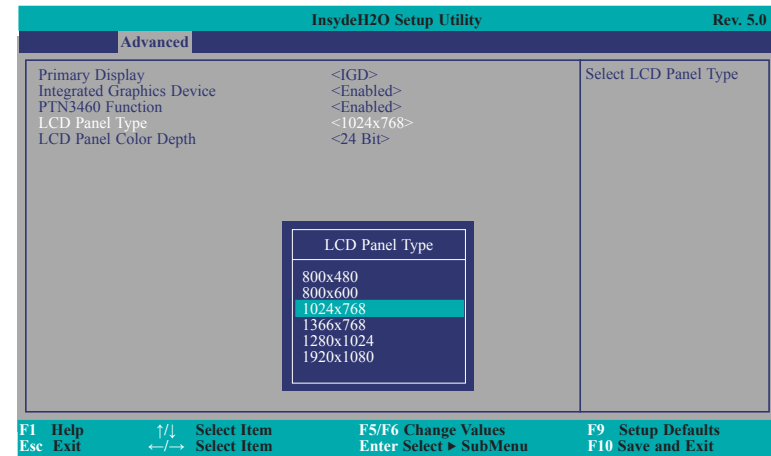

LCD Panel Color Depth

Select the LCD panel color depth: 18 bit, 24 bit, 36 bit or 48 bit.

Audio Configuration

This section configures the audio settings.

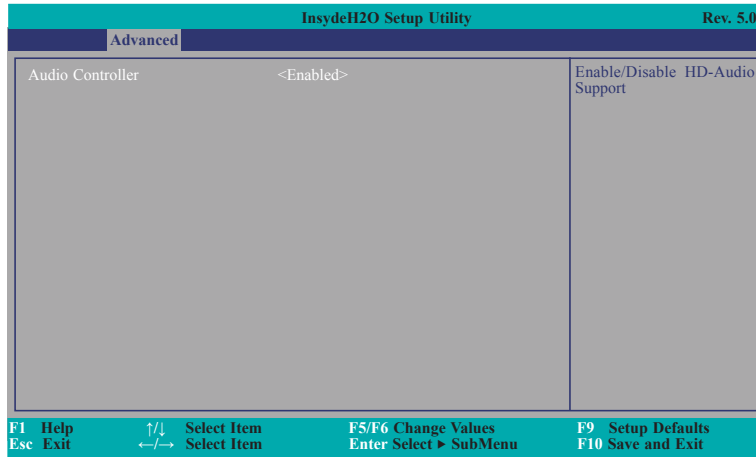

Audio Controller

Control the detection of the high-definition audio device.

Disabled

HD Audio will be disabled.

Enabled

HD Audio will be enabled.

SATA Configuration

This section configures the SATA controller.

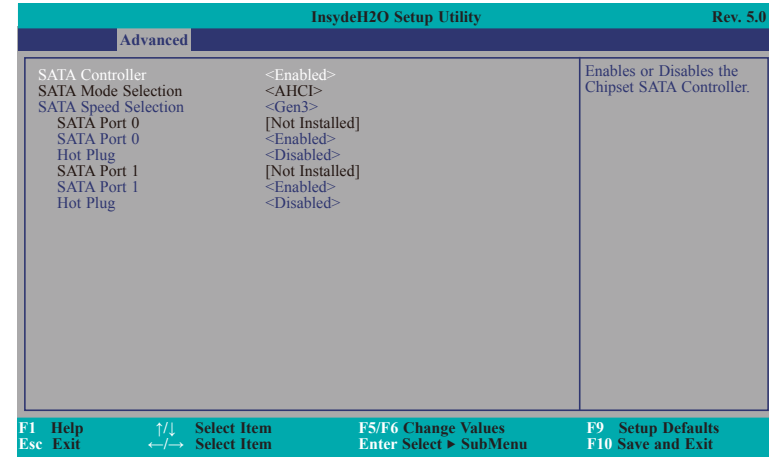

SATA Controller

This field is used to enable or disable the Serial ATA controller.

SATA Mode Selection

The mode selection determines how the SATA controller(s) operates.

AHCI Mode

This option allows the Serial ATA controller(s) to use AHCI (Advanced Host Controller Interface).

SATA Speed Selection

Select Serial ATA controller(s) speed from Gen1 (1.5 Gbit/s), Gen2 (3 Gbit/s) or Gen 3 (6 Gbit/s).

SATA Port 0 and 1/Hot Plug

Enable or disable each Serial ATA port and its hot plug function.

PCI Express Configuration

This section configures settings relevant to PCI Express root ports.

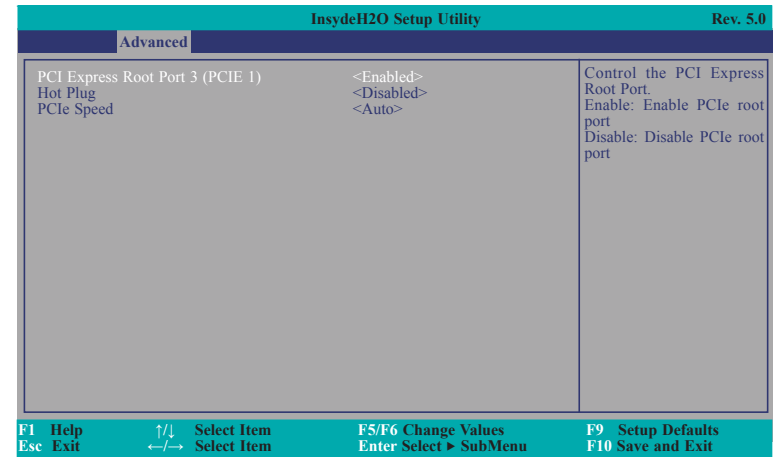
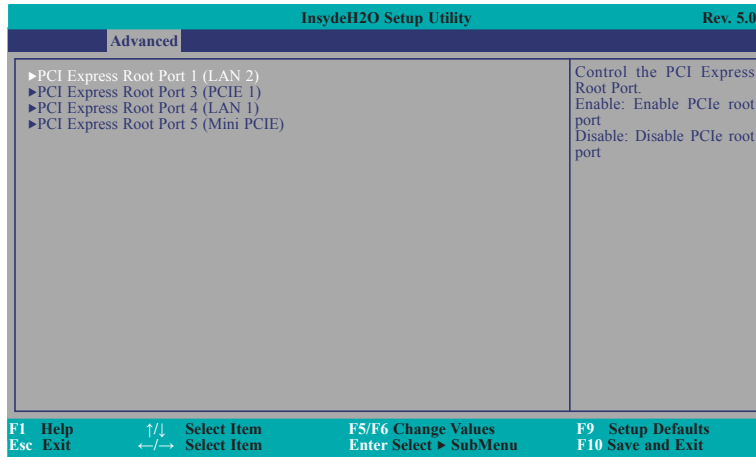

PCI Express Root Port

This field is used to enable or disable the PCI express root port.

Hot Plug

Enable or disable the hot plug function of the PCI Express root port.

PCIe Speed

Select the speed of the PCI Express root port: Auto, Gen1 or Gen2.

Console Redirection

This section configures settings relevant to console redirection.

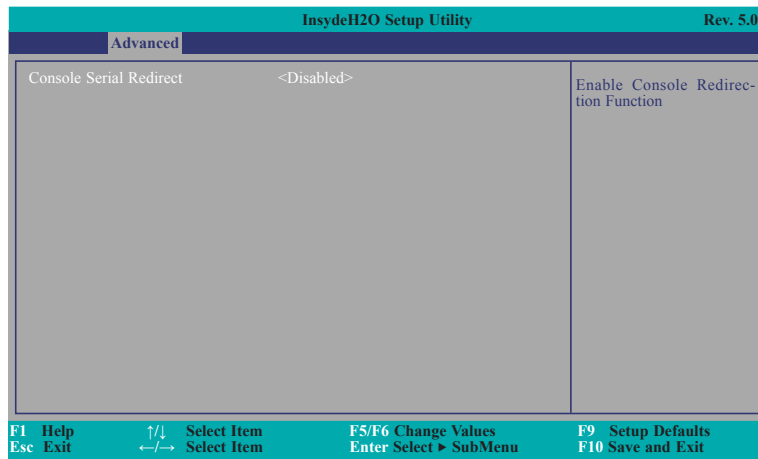

Console Serial Redirect

This field is used to enable or disable the console serial redirection function.

When Console Serial Redirect is set to enabled, it will display the following information:

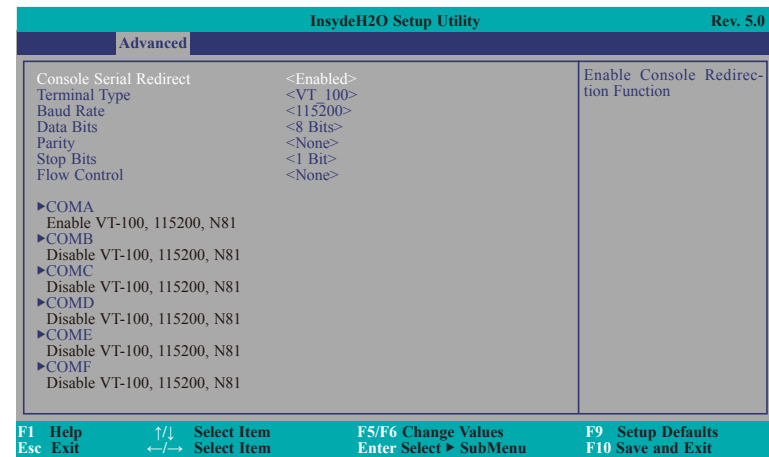

Terminal Type

Select terminal type: VT_100, VT_100+, VT_UTF8 or PC_ANSI.

Baud Rate

Select baud rate: 115200, 57600, 38400, 19200 or 9600.

Data Bits

Select data bits: 7 bits or 8 bits.

Parity

Select parity bits: none, even or odd.

Stop Bits

Select stop bits: 1 bit or 2 bits.

Flow Control

Select flow control type: none, RTS/CTS or XON/XOFF.

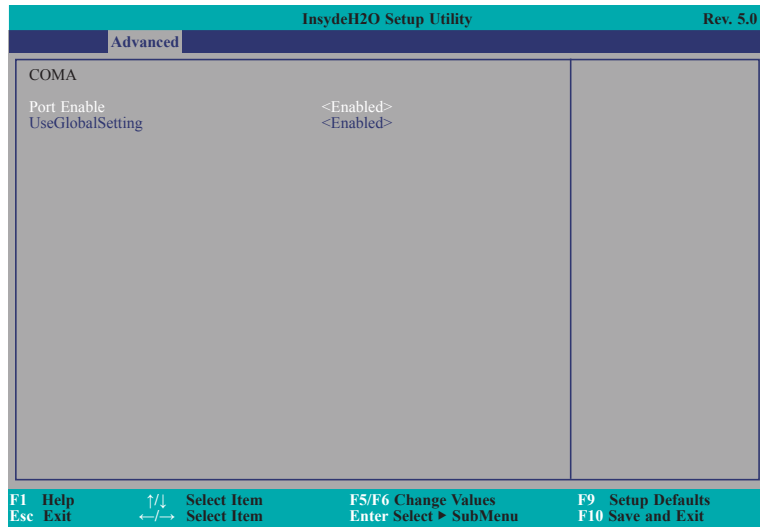
COMA to COMF

When UseGlobalSetting is set to disabled, it will display the following information:

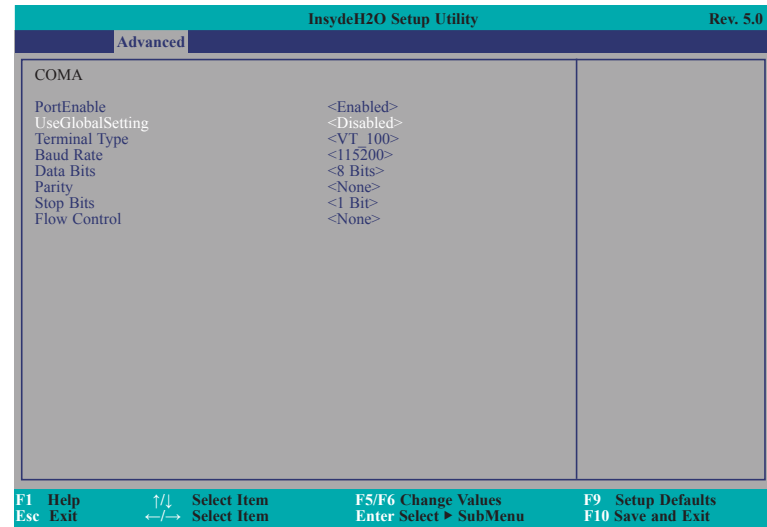
**PortEnable**

This field is used to enable or disable the COM port to redirect the console.

UseGlobalSetting

This field is to enable or disable to use global setting. When enabled the global setting, setting of the COM port will be the same as those in Console Redirection section. When disabled the global setting, setting of the COM port can be configured independently in this section.

SIO NUVOTON6116D

This section configures the system super I/O chip parameters.

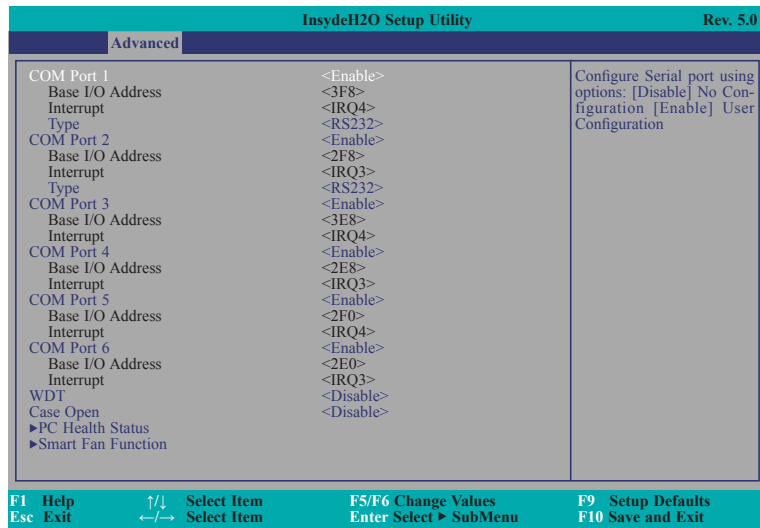

COM Port 1 to COM Port 6

Configure the settings to use the serial port.

Disable No configuration

Enable User configuration

Type

Choose among RS232, RS422 and RS485 (Peer-to-Peer) for the serial communication type for COM port 1 and COM port 2.

WDT

Enable or disable the watchdog function. If enabled, a time-out counter ranges from 1 to 255 seconds will appear.

Case Open

Enable or disable the case open detection function.

PC Health Status

This section displays the system's health information such as the CPU and system temperatures.

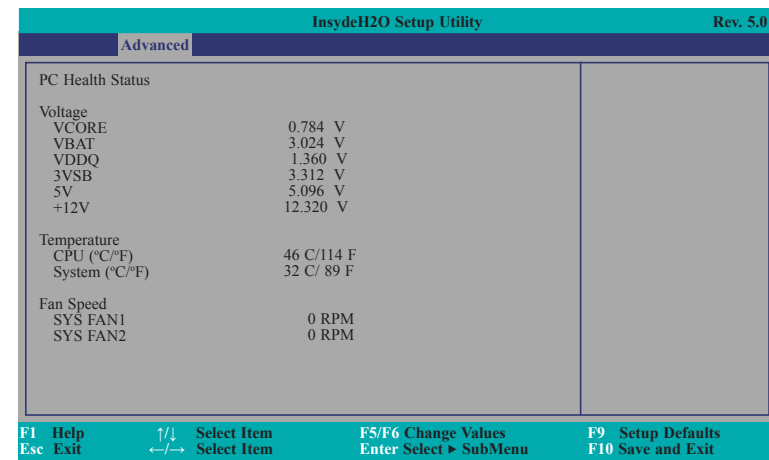

Smart Fan Function

This section configures the Smart Fan Function.

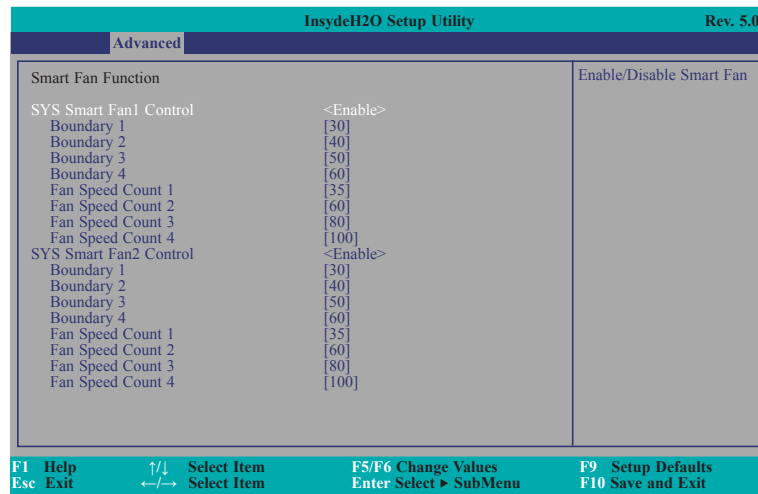

SYS Smart Fan1/Fan2 Control

Enable or disable the system smart fan. If disabled, Fix Fan Speed Count field ranges from 1 to 100% (full speed) will appear.

Boundary 1 to Boundary 4

Set the boundary temperatures that determine the operation of the fan with different fan speeds accordingly. For example, when the system or the CPU temperature reaches boundary 1 temperature, the system or CPU fan should be turned on and operate at the designated speed. The range is from 0-127°C.

Fan Speed Count 1 to Fan Speed Count 4

Set the fan speed. The range is from 1 to 100% (full speed). The fans will operate according to the specified boundary temperatures above.

Security

This section configures the security settings for entering the BIOS setup utility.

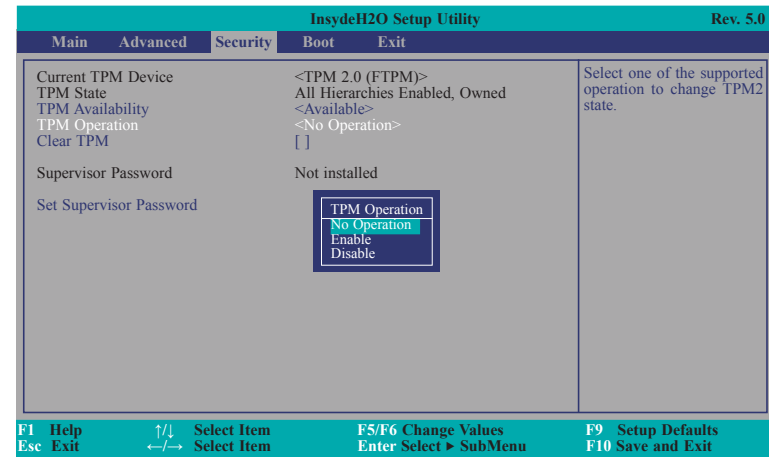

TPM Availability

Show or hide the TPM availability and its configurations.

TPM Operation

Select one of the supported operation to change TPM2 state.

Clear TPM

Remove all TPM context associated with a specific Owner.

Set Supervisor Password

Set the supervisor's password and the length of the password must be greater than one character.

Boot

This section configures boot options.

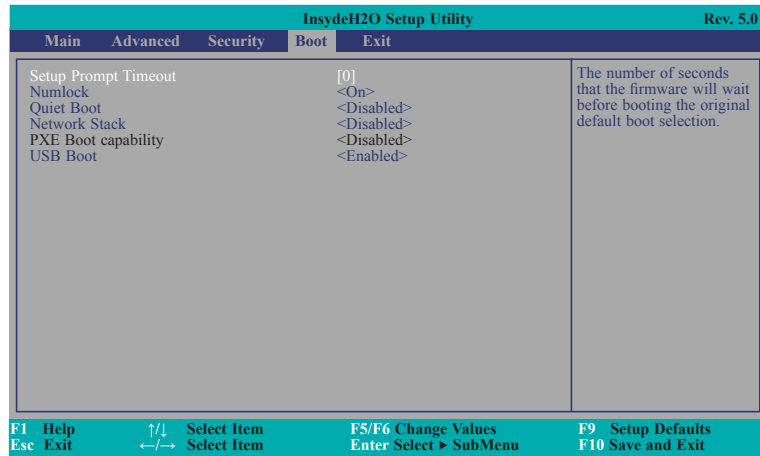

Note:
AL171/AL173 only support UEFI boot, no Legacy boot.

Setup Prompt Timeout

Select the number of seconds that the firmware will wait before booting the original default boot selection.

Numlock

Select the power-on state for numlock: On or Off.

Quiet Boot

Enable or disable booting in text mode.

Network Stack

Enable or disable network stack. It supports the operation of these functions or software: Windows 8 BitLocker Network Unlock, UEFI IPv4/IPv6 PXE and legacy PXE Option ROM.

PXE Boot capability

Disable or enable PXE (Preboot eXecution Environment) boot to LAN.

USB Boot

Enable or disable the booting to USB boot devices.

Exit

This section configures the parameters for exiting the BIOS menu.

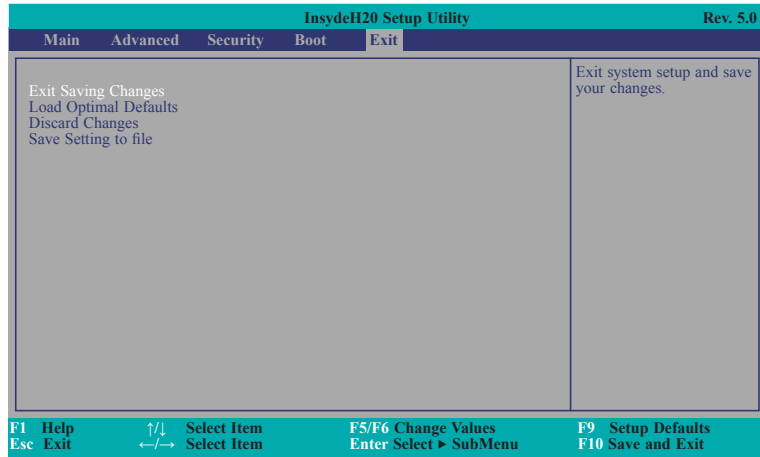

Exit Saving Changes

Select this field and then press <Enter> to exit the system setup and save your changes.

Load Optimal Defaults

Select this field and then press <Enter> to load optimal defaults.

Discard Changes

Select this field and then press <Enter> to exit the system setup without saving your changes.

Save Setting to file

Select this option to save BIOS configuration settings to a USB flash device.

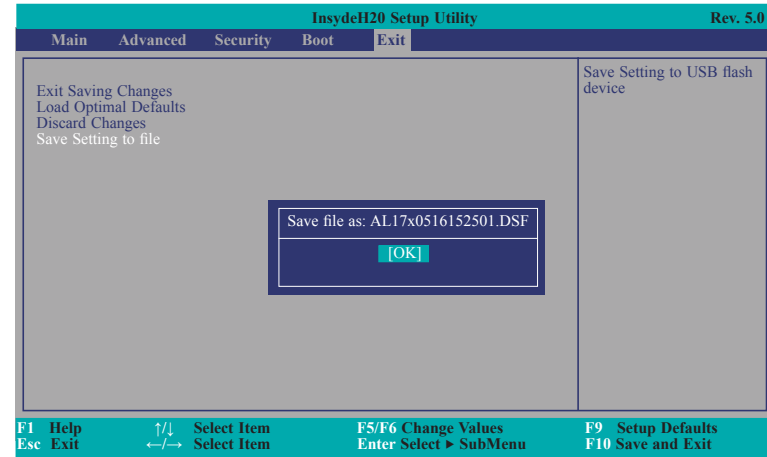

Restore Setting from file

This field will appear only when a USB flash device is detected. Select this field to restore setting from USB flash device.

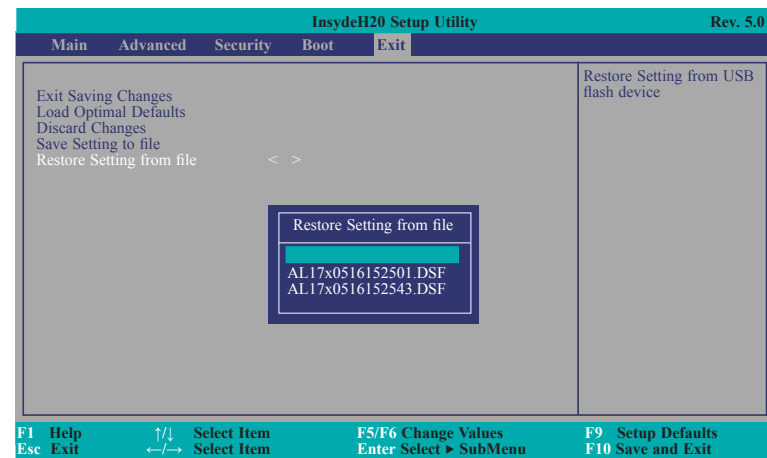

Updating the BIOS

To update the BIOS, you will need the new BIOS file and a flash utility. Please contact technical support or your sales representative for the files and specific instructions about how to update BIOS with the flash utility. For updating Insyde BIOS in UEFI mode, you may refer to the how-to-video at <https://www.dfi.com/Knowledge/Video/31> .

Notice: BIOS SPI ROM

1. The Intel® Trusted Execution Engine has already been integrated into this system board. Due to the safety concerns, the BIOS (SPI ROM) chip cannot be removed from this system board and used on another system board of the same model.
2. The BIOS (SPI ROM) on this system board must be the original equipment from the factory and cannot be used to replace one which has been utilized on other system boards.
3. If you do not follow the methods above, the Intel® Trusted Execution Engine will not be updated and will cease to be effective.

**Note:**

- a. You can take advantage of flash tools to update the default configuration of the BIOS (SPI ROM) to the latest version anytime.
- b. When the BIOS IC needs to be replaced, you have to populate it properly onto the system board after the EEPROM programmer has been burned and follow the technical person's instructions to confirm that the MAC address should be burned or not.

Chapter 4 - Supported Software

Install drivers, utilities and software applications that are required to facilitate and enhance the performance of the system board. You may acquire the software from your sales representatives, from an optional DVD included in the shipment, or from the website download page at <https://www.dfi.com/DownloadCenter>.

Intel Chipset Software Installation Utility

The Intel Chipset Software Installation Utility is used for updating Windows® INF files so that the Intel chipset can be recognized and configured properly in the system.

To install the utility, download "AL171_AL173 Chipset Driver" zip file at our website.

1. Setup is ready to install the utility. Click "Next".

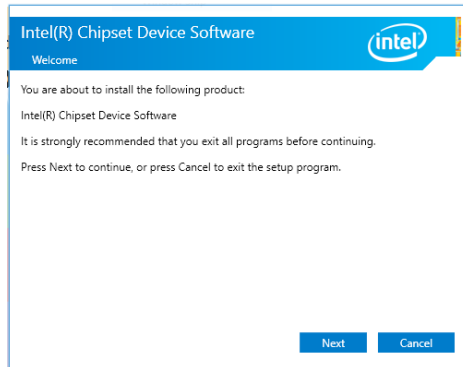

2. Read the license agreement then click "Accept".

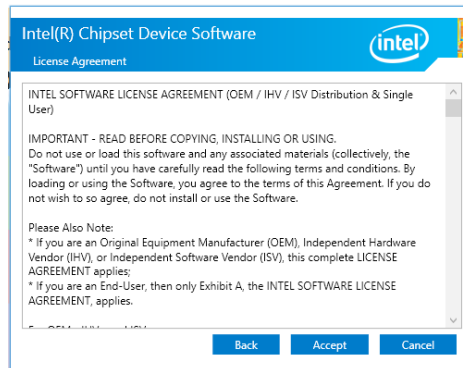

3. Go through the readme document for more installation tips then click "Install".

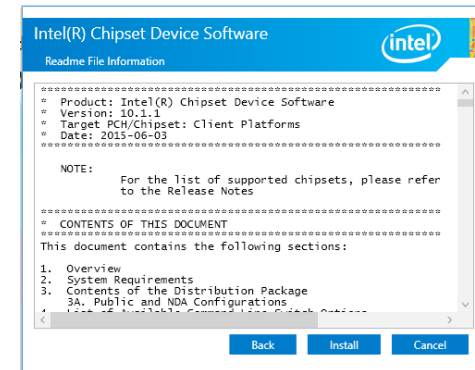

4. The step displays the installing status in the progress.

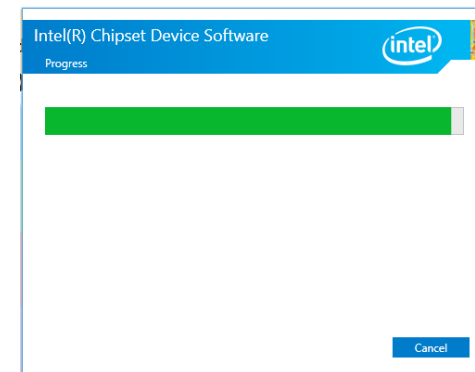

5. After completing installation, click "Restart Now" to exit setup.

Restarting the system will allow the new software installation to take effect.



Intel Graphics Driver

To install the driver, download "AL171_AL173 Graphics Driver" zip file at our website.

1. Setup is now ready to install the graphics driver. Click "Next".

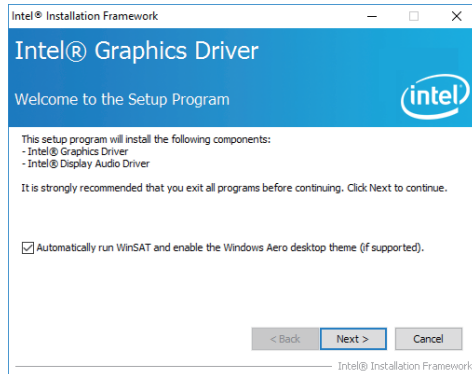

By default, the "Automatically run WinSAT and enable the Windows Aero desktop theme" is enabled. With this enabled, after installing the graphics driver and the system rebooted, the screen will turn blank for 1 to 2 minutes (while WinSAT is running) before the Windows 10 desktop appears. The "blank screen" period is the time Windows is testing the graphics performance.

We recommend that you skip this process by disabling this function then click "Next".

2. Read the license agreement then click "Yes".

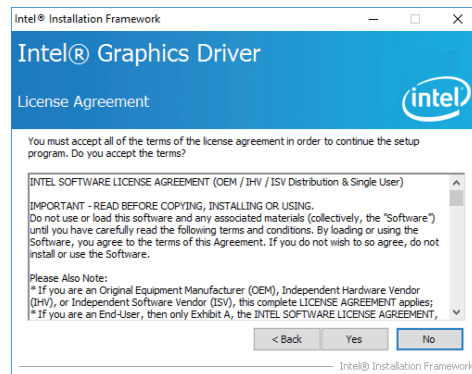

3. Go through the readme document for system requirements and installation tips then click "Next".

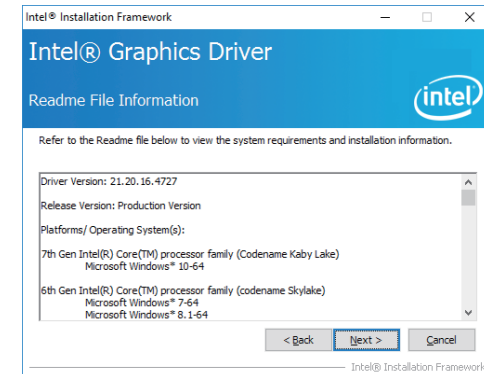

4. Setup is now installing the driver. Click "Next" to continue.

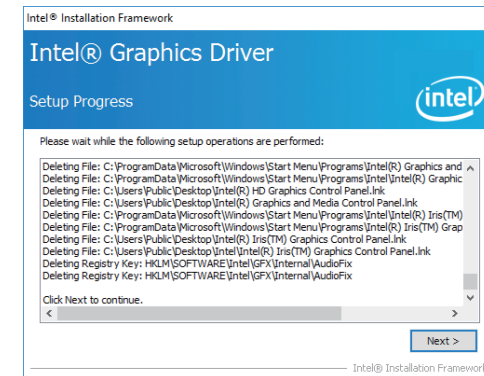

5. Click "Yes, I want to restart this computer now" then click "Finish".

Restarting the system will allow the new software installation to take effect.

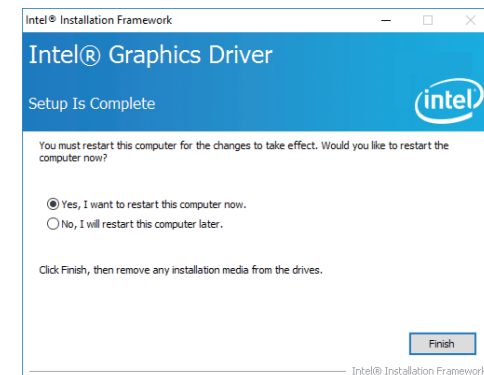

Audio Driver

To install the driver, download "AL171_AL173 Audio Driver" zip file at our website.

1. Setup is ready to install the driver. Click "Next".

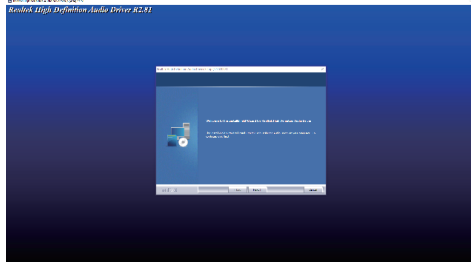

2. Click "Yes, I want to restart my computer now" then click "Finish".

Restarting the system will allow the new software installation to take effect.

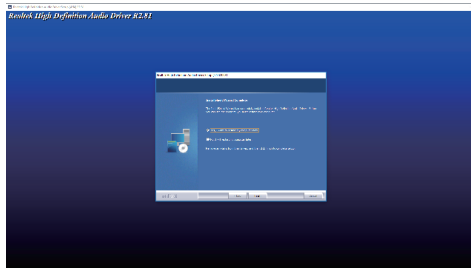

Intel LAN Driver

To install the driver, download "AL171_AL173 LAN Driver" zip file at our website.

1. Setup is ready to install the driver. Click "Next".

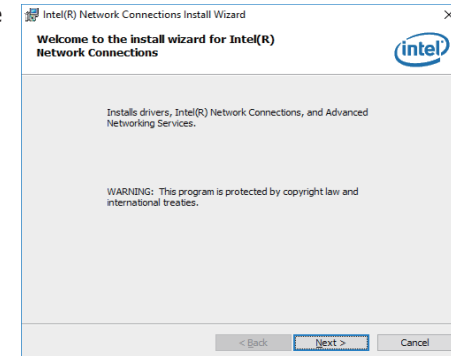

2. Click "I accept the terms in the license agreement" then click "Next".

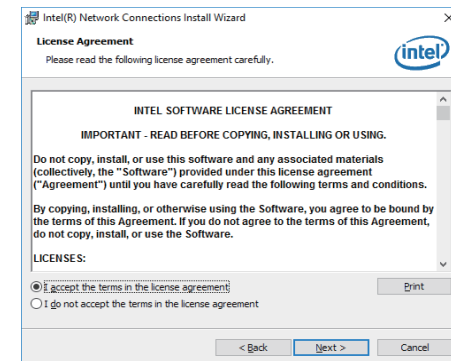

3. Select the program features you want installed then click "Next".

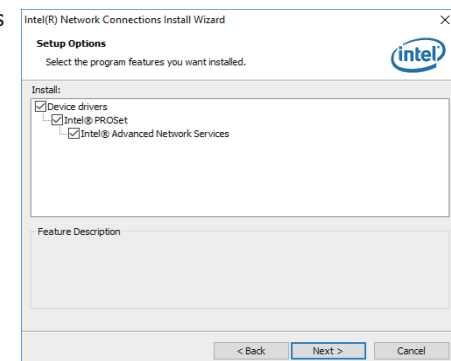

4. Click "Install" to begin the installation.

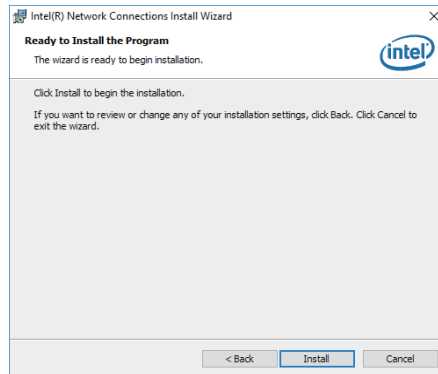

5. The step displays the installing status in the progress.

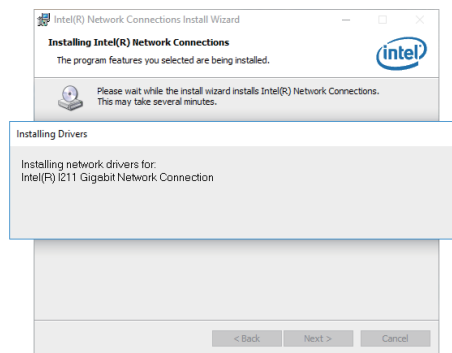

6. After completing installation, click "Finish".

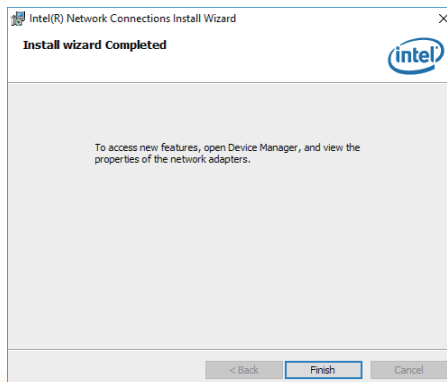

Intel Trusted Execution Engine Drivers

To install the driver, download "AL171 AL173 TXE Driver" zip file at our website.

1. Tick "I accept the terms in the License Agreement" and then click "Next."

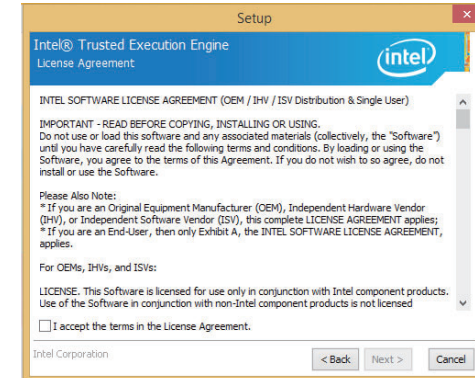

2. The step shows the components which will be installed. Then, Click Next.

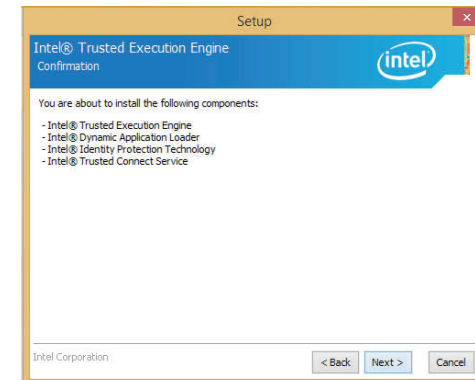

3. The step displays the installing status in the progress.

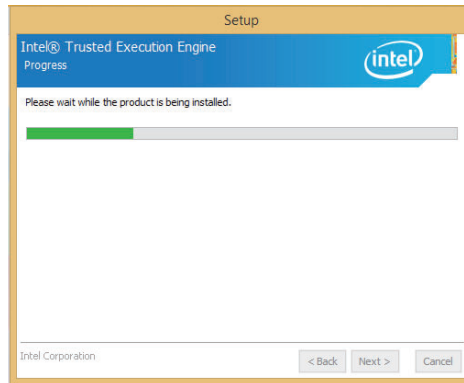

4. Click "Finish" when the installation is complete.

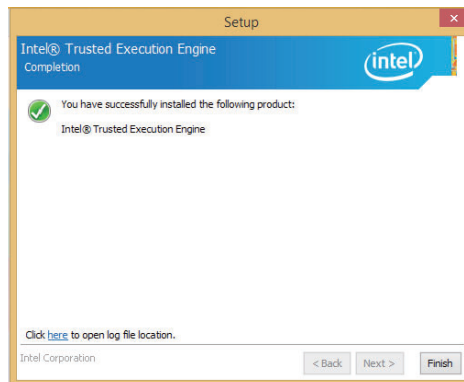

SIO Driver

To install the driver, download "AL171_AL173 SIO Driver" zip file at our website.

1. Setup is ready to install the driver.
Click "Next".

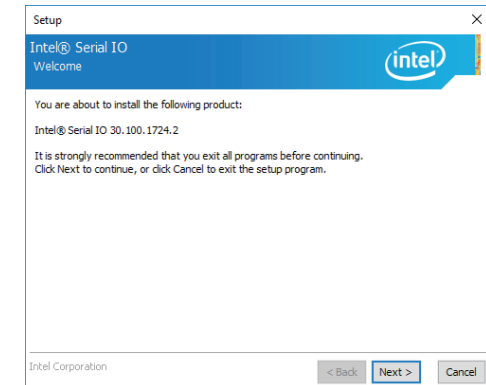

2. Read the license agreement carefully.
Tick "I accept the terms in the License Agreement" then click "Next".



3. Go through the readme document for system requirements and installation tips then click "Next".

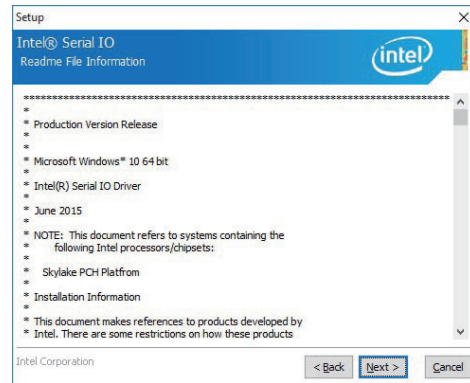

4. Setup is ready to install the driver. Click "Next".

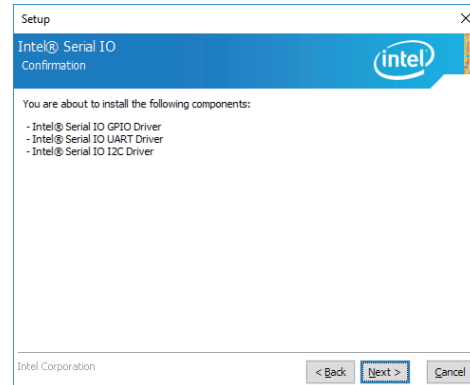

5. Setup is now installing the driver.

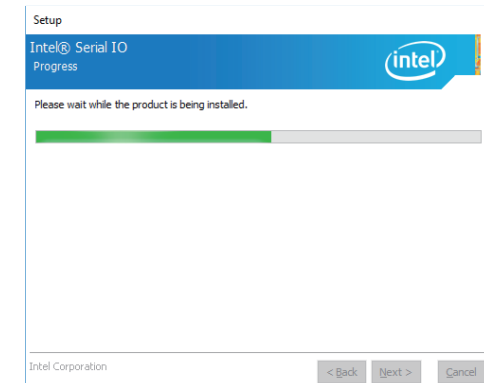

6. Click "Yes, I want to restart this computer now" then click "Finish".

Restarting the system will allow the new software installation to take effect.

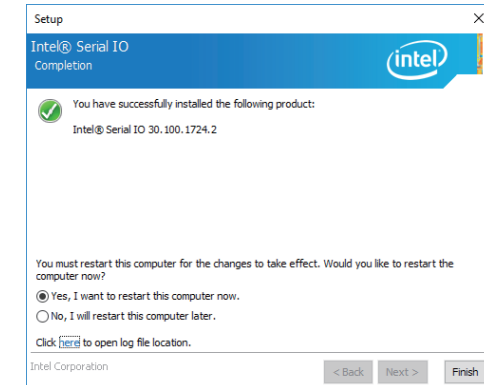

Appendix A - Troubleshooting Checklist

Troubleshooting Checklist

This chapter of the manual is designed to help you with problems that you may encounter with your personal computer. To efficiently troubleshoot your system, treat each problem individually. This is to ensure an accurate diagnosis of the problem in case a problem has multiple causes.

Some of the most common things to check when you encounter problems while using your system are listed below.

1. The power switch of each peripheral device is turned on.
2. All cables and power cords are tightly connected.
3. The electrical outlet to which your peripheral devices connected is working. Test the outlet by plugging in a lamp or other electrical device.
4. The monitor is turned on.
5. The display's brightness and contrast controls are adjusted properly.
6. All add-in boards in the expansion slots are seated securely.
7. Any add-in board you have installed is designed for your system and is set up correctly.

Monitor/Display

If the display screen remains dark after the system is turned on:

1. Make sure that the monitor's power switch is on.
2. Check that one end of the monitor's power cord is properly attached to the monitor and the other end is plugged into a working AC outlet. If necessary, try another outlet.
3. Check that the video input cable is properly attached to the monitor and the system's display adapter.
4. Adjust the brightness of the display by turning the monitor's brightness control knob.

The picture seems to be constantly moving.

1. The monitor has lost its vertical sync. Adjust the monitor's vertical sync.
2. Move away any objects, such as another monitor or fan, that may be creating a magnetic field around the display.
3. Make sure your video card's output frequencies are supported by this monitor.

The screen seems to be constantly wavering.

1. If the monitor is close to another monitor, the adjacent monitor may need to be turned off. Fluorescent lights adjacent to the monitor may also cause screen wavering.

Power Supply

When the computer is turned on, nothing happens.

1. Check that one end of the AC power cord is plugged into a live outlet and the other end properly plugged into the back of the system.
2. Make sure that the voltage selection switch on the back panel is set for the correct type of voltage you are using.
3. The power cord may have a "short" or "open". Inspect the cord and install a new one if necessary.

Hard Drive

Hard disk failure.

1. Make sure the correct drive type for the hard disk drive has been entered in the BIOS.
2. If the system is configured with two hard drives, make sure the bootable (first) hard drive is configured as Master and the second hard drive is configured as Slave. The master hard drive must have an active/bootable partition.

Excessively long formatting period.

If your hard drive takes an excessively long period of time to format, it is likely a cable connection problem. However, if your hard drive has a large capacity, it will take a longer time to format.

Serial Port

The serial device (modem, printer) doesn't output anything or is outputting garbled characters.

1. Make sure that the serial device's power is turned on and that the device is on-line.
2. Verify that the device is plugged into the correct serial port on the rear of the computer.
3. Verify that the attached serial device works by attaching it to a serial port that is working and configured correctly. If the serial device does not work, either the cable or the serial device has a problem. If the serial device works, the problem may be due to the onboard I/O or the address setting.
4. Make sure the COM settings and I/O address are configured correctly.

Keyboard

Nothing happens when a key on the keyboard was pressed.

1. Make sure the keyboard is properly connected.
2. Make sure there are no objects resting on the keyboard and that no keys are pressed during the booting process.

System Board

1. Make sure the add-in card is seated securely in the expansion slot. If the add-in card is loose, power off the system, re-install the card and power up the system.
2. Check the jumper settings to ensure that the jumpers are properly set.
3. Verify that all memory modules are seated securely into the memory sockets.
4. Make sure the memory modules are in the correct locations.
5. If the board fails to function, place the board on a flat surface and seat all socketed components. Gently press each component into the socket.
6. If you made changes to the BIOS settings, re-enter setup and load the BIOS defaults.