

PR611-C621

ATX Industrial Motherboard
User's Manual

Copyright

This publication contains information that is protected by copyright. No part of it may be reproduced in any form or by any means or used to make any transformation/adaptation without the prior written permission from the copyright holders.

This publication is provided for informational purposes only. The manufacturer makes no representations or warranties with respect to the contents or use of this manual and specifically disclaims any express or implied warranties of merchantability or fitness for any particular purpose. The user will assume the entire risk of the use or the results of the use of this document. Further, the manufacturer reserves the right to revise this publication and make changes to its contents at any time, without obligation to notify any person or entity of such revisions or changes.

Changes after the publication's first release will be based on the product's revision. The website will always provide the most updated information.

© 2020. All Rights Reserved.

Trademarks

Product names or trademarks appearing in this manual are for identification purpose only and are the properties of the respective owners.

FCC and DOC Statement on Class B

This equipment has been tested and found to comply with the limits for a Class B digital device, pursuant to Part 15 of the FCC rules. These limits are designed to provide reasonable protection against harmful interference when the equipment is operated in a residential installation. This equipment generates, uses and can radiate radio frequency energy and, if not installed and used in accordance with the instruction manual, may cause harmful interference to radio communications. However, there is no guarantee that interference will not occur in a particular installation. If this equipment does cause harmful interference to radio or television reception, which can be determined by turning the equipment off and on, the user is encouraged to try to correct the interference by one or more of the following measures:

- Reorient or relocate the receiving antenna.
- Increase the separation between the equipment and the receiver.
- Connect the equipment into an outlet on a circuit different from that to which the receiver is connected.
- Consult the dealer or an experienced radio TV technician for help.

Notice:

1. The changes or modifications not expressly approved by the party responsible for compliance could void the user's authority to operate the equipment.
2. Shielded interface cables must be used in order to comply with the emission limits.

Table of Contents

Chapter 1 - Introduction	6
Specifications	6
Features	8
Chapter 2 - Hardware Installation	8
Board Layout.....	8
LED and Switch	8
System Memory	9
Installing the DIMM Module	9
Removing the DIMM Module.....	10
CPU.....	11
Installing the CPU, Fan and Heat Sink.....	11
Jumper Settings	13
Clear CMOS.....	13
ME Firmware Update.....	13
Rear I/O Ports.....	14
Graphics Display.....	14
COM (Serial) ports.....	15
RJ45 LAN Ports.....	15
USB Ports.....	16
Internal I/O Connectors	17
SATA (Serial ATA)	17
Front Audio.....	17
Cooling Fan Connectors.....	18
Power Connector	18
Chassis Intrusion.....	19
Front Panel.....	19
Expansion Slots	20
Installing the M.2 Module	20
LPC	21
Battery	22
SMBus	22
JTAG PLD Programming.....	23
Chapter 3 - BIOS Settings	24
Overview	24
Main.....	30
Advanced	30
RC ACPI Configuration.....	31
CPU Configuration.....	31
Video Configuration.....	32
SATA Configuration	32
USB Configuration	34
PCI Express Configuration.....	34
Debug Configuration	35
UEFI Device Manager	35
USB Power Control	36
SIO NCT6112D.....	36
SIO AST2500/AST2510.....	38
H2O IPMI Configuration.....	38
Console Redirection	41
Security	42

Boot.....	42
Exit.....	44
Updating the BIOS.....	44
Notice: BIOS SPI ROM.....	44
Chapter 4 - RAID	45
RAID Levels.....	45
Setup Procedure.....	45

About this Manual

This manual can be downloaded from the website. The manual is subject to change and update without notice, and may be based on editions that do not resemble your actual products. Please visit our website or contact our sales representatives for the latest editions.

Warranty

1. Warranty does not cover damages or failures that arised from misuse of the product, inability to use the product, unauthorized replacement or alteration of components and product specifications.
2. The warranty is void if the product has been subjected to physical abuse, improper installation, modification, accidents or unauthorized repair of the product.
3. Unless otherwise instructed in this user's manual, the user may not, under any circumstances, attempt to perform service, adjustments or repairs on the product, whether in or out of warranty. It must be returned to the purchase point, factory or authorized service agency for all such work.
4. We will not be liable for any indirect, special, incidental or consequential damages to the product that has been modified or altered.

Static Electricity Precautions

It is quite easy to inadvertently damage your PC, system board, components or devices even before installing them in your system unit. Static electrical discharge can damage computer components without causing any signs of physical damage. You must take extra care in handling them to ensure against electrostatic build-up.

1. To prevent electrostatic build-up, leave the system board in its anti-static bag until you are ready to install it.
2. Wear an antistatic wrist strap.
3. Do all preparation work on a static-free surface.
4. Hold the device only by its edges. Be careful not to touch any of the components, contacts or connections.
5. Avoid touching the pins or contacts on all modules and connectors. Hold modules or connectors by their ends.



Important:

Electrostatic discharge (ESD) can damage your processor, disk drive and other components. Perform the upgrade instruction procedures described at an ESD workstation only. If such a station is not available, you can provide some ESD protection by wearing an antistatic wrist strap and attaching it to a metal part of the system chassis. If a wrist strap is unavailable, establish and maintain contact with the system chassis throughout any procedures requiring ESD protection.

Safety Measures

- To avoid damage to the system, use the correct AC input voltage range.
- To reduce the risk of electric shock, unplug the power cord before removing the system chassis cover for installation or servicing. After installation or servicing, cover the system chassis before plugging the power cord.

About the Package

The package contains the following items. If any of these items are missing or damaged, please contact your dealer or sales representative for assistance.

1 PR611-C621 motherboard

1 I/O shield A49-PR6110-020G

2 M.2 screw A32-112016-041G

1 CPU Clip 348-436471-100G

The board and accessories in the package may not come similar to the information listed above. This may differ in accordance with the sales region or models in which it was sold. For more information about the standard package in your region, please contact your dealer or sales representative.

Optional Items

USB 2.0 port cable

Cooler

USB 3.1 Gen1 cable

Serial ATA data cable

The board and accessories in the package may not come similar to the information listed above. This may differ in accordance with the sales region or models in which it was sold. For more information about the standard package in your region, please contact your dealer or sales representative.

Before Using the System Board

When installing the system board in a new system, you will need at least the following internal components.

- CPU
- Memory module
- Storage device such as hard disk drive, CD-ROM, etc.
- Power adaptor

External system peripherals may also be required for navigation and display, including at least a keyboard, a mouse and a video display monitor.

Chapter 1 - Introduction

► Specifications

SYSTEM	Processor
	<p>1st Generation Intel® Xeon® Scalable Processor Family, LGA 3647 Socket: Intel® Xeon® Platinum 8160T (24 Cores, 27.5M Cache, up to 3.7 GHz); 150W Intel® Xeon® Gold 6138T (20 Cores, 27.5M Cache, up to 3.7 GHz); 125W Intel® Xeon® Gold 6138 (20 Cores, 27.5M Cache, up to 3.7 GHz); 125W Intel® Xeon® Gold 6130T (16 Cores, 22M Cache, up to 3.7 GHz); 125W Intel® Xeon® Gold 6130 (16 Cores, 22M Cache, up to 3.7 GHz); 125W Intel® Xeon® Gold 6126T (12 Cores, 19.25M Cache, up to 3.7 GHz); 125W Intel® Xeon® Gold 6126 (12 Cores, 19.25M Cache, up to 3.7 GHz); 125W</p> <hr/> <p>Intel® Xeon® Gold 5120T (14 Cores, 19.25M Cache, up to 3.2 GHz); 105W Intel® Xeon® Gold 5119T (14 Cores, 19.25M Cache, up to 3.2 GHz); 85W Intel® Xeon® Gold 5118 (12 Cores, 16.5M Cache, up to 3.2 GHz); 105W Intel® Xeon® Silver 4116T (12 Cores, 16.5M Cache, up to 3.0 GHz); 85W Intel® Xeon® Silver 4116 (12 Cores, 16.5M Cache, up to 3.0 GHz); 85W Intel® Xeon® Silver 4114T (10 Cores, 13.75M Cache, up to 3.0 GHz); 85W Intel® Xeon® Silver 4110 (8 Cores, 11M Cache, up to 3.0 GHz); 85W Intel® Xeon® Silver 4109T (8 Cores, 11M Cache, up to 3.0 GHz); 70W Intel® Xeon® Bronze 3106 (8 Cores, 11M Cache, 1.7 GHz); 85W</p>

	<p>2nd Generation Intel® Xeon® Scalable Processor Family, LGA 3647 Socket: Intel® Xeon® Gold 6252N (24 Cores, 35.75M Cache, up to 3.6 GHz); 150W Intel® Xeon® Gold 6238T (22 Cores, 30.25M Cache, up to 3.7 GHz); 125W Intel® Xeon® Gold 6230T (20 Cores, 27.5M Cache, up to 3.9 GHz); 125W Intel® Xeon® Gold 6230N (20 Cores, 27.5M Cache, up to 3.5 GHz); 125W Intel® Xeon® Gold 6230 (20 Cores, 27.5M Cache, up to 3.9 GHz); 125W Intel® Xeon® Gold 6226 (12 Cores, 19.25M Cache, up to 3.7 GHz); 125W Intel® Xeon® Gold 5220T (18 Cores, 24.75M Cache, up to 3.9 GHz); 105W Intel® Xeon® Gold 5218T (16 Cores, 22M Cache, up to 3.8 GHz); 105W Intel® Xeon® Gold 5218N (16 Cores, 22M Cache, up to 3.7 GHz); 110W Intel® Xeon® Gold 5215 (10 Cores, 13.75M Cache, up to 3.4 GHz); 85W Intel® Xeon® Silver 4216 (16 Cores, 22M Cache, up to 3.2 GHz); 100W Intel® Xeon® Silver 4215 (8 Cores, 11M Cache, up to 3.5 GHz); 85W Intel® Xeon® Silver 4214 (12 Cores, 16.5M Cache, up to 3.2 GHz); 85W Intel® Xeon® Silver 4210 (10 Cores, 13.75M Cache, up to 3.2 GHz); 85W Intel® Xeon® Silver 4209 (8 Cores, 11M Cache, up to 3.2 GHz); 70W</p>
	<p>Chipset Intel® C621 Chipset</p>
	<p>Memory 6 x 288-pin ECC-RDIMM up to 384GB Single Channel DDR4 up to 2933 MHZ Support Optane DC persistent memory module(DCPMM) in DIMM3 and DIMM6 (2nd Gen Xeon Scalable (62xx/52xx/ 4215) processors only)</p>
	<p>BIOS Insyde SPI 128Mbit</p>
Graphics	<p>Display 1 x VGA (opt.)</p> <p>Single Display VGA (opt.)</p>
Expansion	<p>Interface 3 x PCIe x16 (Gen 3) 3 x PCIe x8 (Gen 3)(share w/ PCIe x16) 1 x M.2 M key 2280 (SATA/PCIe Gen3 x4 NVMe) 1 x M.2 E key 2230 (USB 2.0/PCIe Gen3 x2) Note: PCIe x8 slot is OPEN edge.</p>
Audio	<p>Audio Codec ALC887</p>
Ethernet	<p>Controller 2 x Intel® I210AT PCIe (10/100/1000Mbps) IPMI: RTL8211F (opt.)</p>

Rear I/O	Ethernet	2 x GbE (RJ-45) 1 x dedicated IPMI LAN (opt.)
	Serial	1 x RS-232 (DB-9)
	USB	4x USB 3.1 Gen1 2x USB 2.0 stack (opt.w/ RJ45+USB2.0 stack)
Internal I/O	USB	2x USB 2.0 header (2x USB 2.0) 1x USB 2.0 vertical Type A 1x USB 3.1 Gen1 header (2x USB 3.1 Gen1)
	SATA	6 x SATA 3.0 (up to 6Gb/s) RAID 0/1/5/10
	SMBus	1 x SMBus
Watchdog Timer	Output & Interval	System Reset, Programmable via Software from 1 to 255 sec/Min
Security	TPM	TPM 2.0 (opt.)
Power	Type	ATX
	Connector	8-pin ATX 12V power 24-pin ATX power
	Consumption	Idle: Xeon Gold 5218 - 3.3V @ 0.06A (0.198Watt); 5V @ 1.75A (8.75Watt); 12V @ 1.67A (20.04Watt) Max.: Xeon Gold 5218 - 3.3V @ 0.08A (0.264Watt); 5V @ 2.94A (14.7Watt); 12V @ 11.53A (138.36Watt) Idle: Xeon Platinum 8276M - 3.3V @ 0.03A (0.099Watt); 5V @ 1.65A (8.25Watt); 12V @ 1.63A (19.56Watt) Max.: Xeon Platinum 8276M - 3.3V @ 0.05A (0.165Watt); 5V @ 2.65A (13.25Watt); 12V @ 18.43A (221.16Watt)
	Battery	CR2032 Coin Cell
OS Support	OS Support	Windows 10 IoT Enterprise LTSB RS5(64-bit) Windows Server 2019 Windows Server 2016 Linux
	Environment	Temperature Operating: -5 to 65°C Storage: -40 to 85°C
Environment	Humidity	Operating: 5 to 90% RH, Non-condensing Storage: 5 to 90% RH, Non-condensing
	MTBF	PR611-C621: 558,025 hrs @ 25°C; 339,879 hrs @ 45°C ; 224,136 hrs @ 60°C PR611-C621 w/ IPMI-Mgmt: 510,709 hrs @ 25°C; 306,113 hrs @ 45°C ; 200,130 hrs @ 60°C Calculation Model: Telcordia Issue 4 Environment: GB, GC - Ground Benign, Controlled
	Mechanism	Dimensions ATX Form Factor 305mm (12") x 244mm (9.6")
Mechanism	Height	PCB: 1.6mm / Top Side: 37.34mm
	Packing List	Packing List 1 PR611-C621 motherboard 1 I/O shield A49-PR6110-020G 2 M.2 screw A32-112016-041G 1 CPU Clip 348-436471-100G

Country of Origin	Country of Origin	Taiwan
--------------------------	--------------------------	--------

► Features

Watchdog Timer

The Watchdog Timer function allows your application to regularly “clear” the system at the set time interval. If the system hangs or fails to function, it will reset at the set time interval so that your system will continue to operate.

DDR4

DDR4 delivers increased system bandwidth and improves performance. The advantages of DDR4 provide an extended battery life and improve the performance at a lower power than DDR3/DDR2.

Serial ATA

Serial ATA is a storage interface that is compliant with SATA 1.0a specification. With speed of up to 6Gb/s (SATA 3.0), it improves hard drive performance faster than the standard parallel ATA whose data transfer rate is 100MB/s.

Gigabit LAN

Two Intel® Gigabit LAN controllers (Intel® I210AT PCIe) support up to 1Gbps data transmission.

Audio

The Realtek ALC887 audio codec provides high-performance of 7.1 channel High Definition audio output.

Wake-On-LAN

This feature allows the network to remotely wake up a Soft Power Down (Soft-Off) PC. It is supported via the onboard LAN port or via a PCI LAN card that uses the PCI PME (Power Management Event) signal. However, if your system is in the Suspend mode, you can power-on the system only through an IRQ or DMA interrupt.

Wake-On-USB

This function allows you to use a USB keyboard or USB mouse to wake up a system from the S3 (STR - Suspend To RAM) state.

PCI Express

PCI Express is a high bandwidth I/O infrastructure that possesses the ability to scale speeds by forming multiple lanes. The x4 PCI Express lane supports transfer rate of 4 Gigabyte per second (2 directions). The PCI Express architecture also supports high performance graphics infrastructure by enhancing the capability of a PCIe x16 Gen 3 at 16GB/s bandwidth (8GB/s in each direction).

ACPI STR

The system board is designed to meet the ACPI (Advanced Configuration and Power Interface) specification. ACPI has energy saving features that enables PCs to implement Power Management and Plug-and-Play with operating systems that support OS Direct Power Management. ACPI when enabled in the Power Management Setup will allow you to use the Suspend to RAM function.

With the Suspend to RAM function enabled, you can power-off the system at once by pressing the power button or selecting “Standby” when you shut down Windows® without having to go through the sometimes tiresome process of closing files, applications and operating system. This is because the system is capable of storing all programs and data files during the entire operating session into RAM (Random Access Memory) when it powers-off. The operating session will resume exactly where you left off the next time you power-on the system.

Power Failure Recovery

When power returns after an AC power failure, you may choose to either power-on the system manually or let the system power-on automatically.

USB

The system board supports the new USB 3.1 Gen 1. It is capable of running at a maximum transmission speed of up to 5 Gbit/s (625 MB/s), and is faster than USB 2.0 (480 Mbit/s, or 60 MB/s) and USB 1.1 (12Mb/s). USB 3.1 reduces the time required for data transmission, reduces power consumption, and is backward compatible with USB 2.0. It is a marked improvement in device transfer speeds between your computer and a wide range of simultaneously accessible external Plug and Play peripherals.

RTC Timer

The Real Time Clock (RTC) installed on the system board allows your system to automatically power-on on the set date and time.

Chapter 2 - Hardware Installation

Board Layout

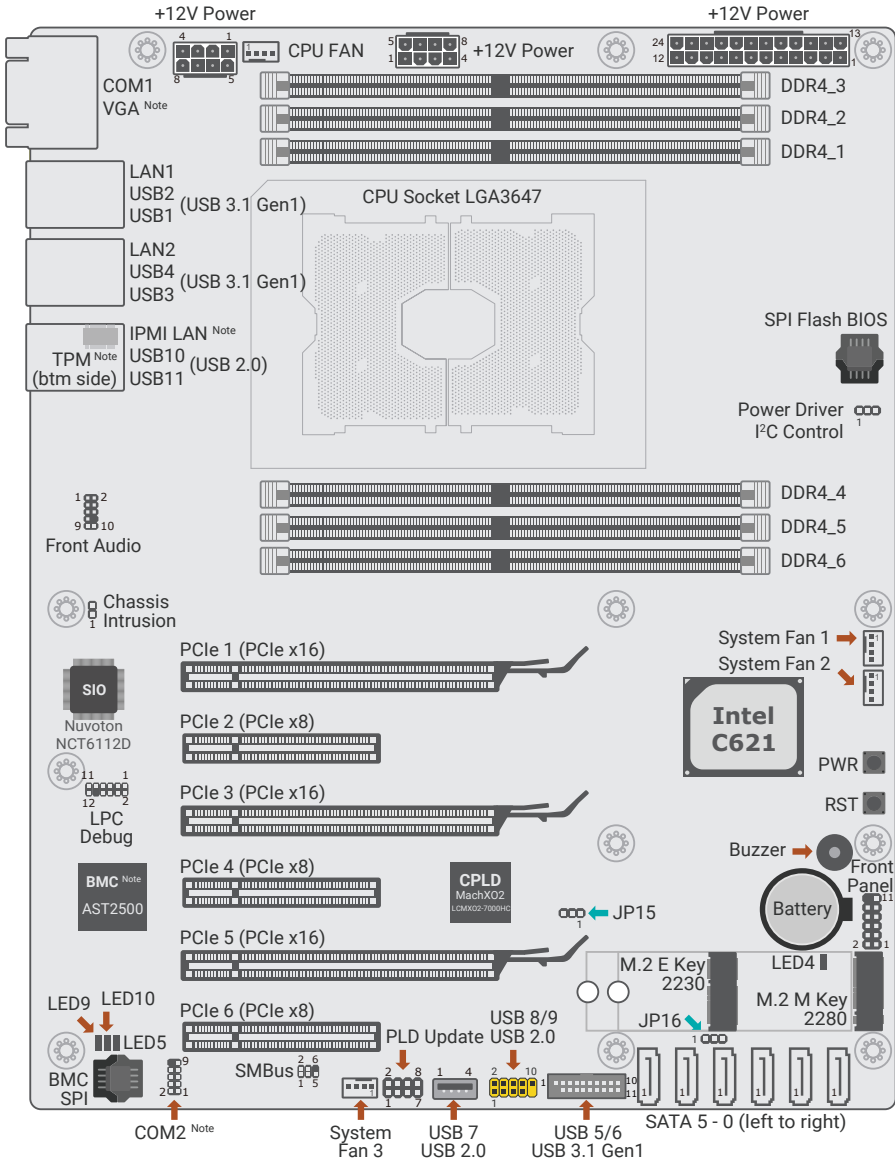

Note: Some components are optional and only available upon request.

Important: Electrostatic discharge (ESD) can damage your board, processor, disk drives, add-in boards, and other components. Perform installation procedures at an ESD workstation only. If such a station is not available, you can provide some ESD protection by wearing an antistatic wrist strap and attaching it to a metal part of the system chassis. If a wrist strap is unavailable, establish and maintain contact with the system chassis throughout any procedures requiring ESD protection.

LED and Switch

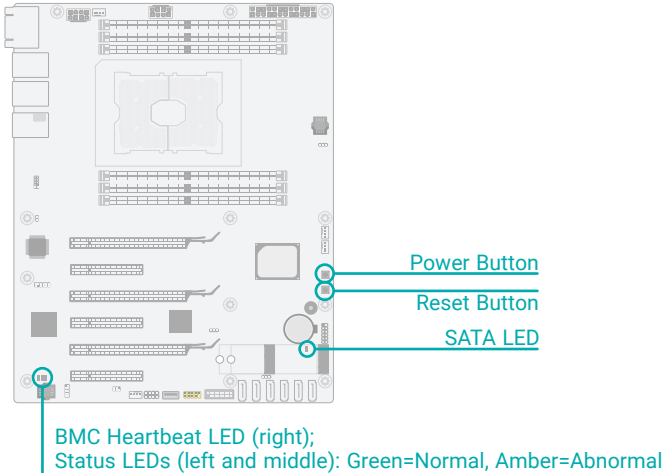

► System Memory

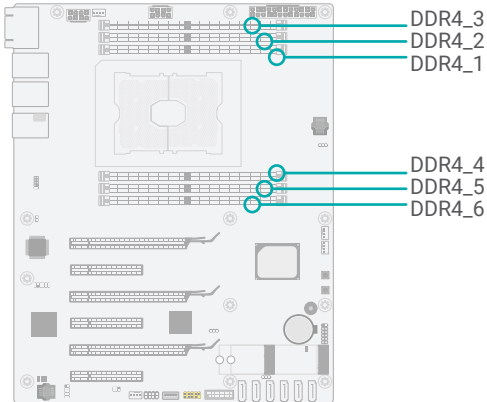

The system board supports the following memory interface.

Single Channel (SC)

Data will be accessed in chunks of 64 bits from the memory channels. DIMMs are on the same channel. DIMMs in a channel can be identical or completely different. However, we highly recommend using identical DIMMs. Not all slots need to be populated.

Features

- Six 288-pin ECC-RDIMM up to 384GB
- Single Channel DDR4 up to 2933 MHz

**2nd Gen Xeon Scalable (62xx/52xx/4215) processors support Optane DC persistent memory module (DCPMM), in DIMM3 and DIMM6.

► System Memory

Installing the DIMM Module

Before installing the memory module, please make sure that the following safety cautions are well-attended.

1. Make sure the PC and all other peripheral devices connected to it has been powered down.
2. Disconnect all power cords and cables.
3. Locate the DIMM socket on the system board
4. Make sure the notch on memory card is aligned to the key on the socket.

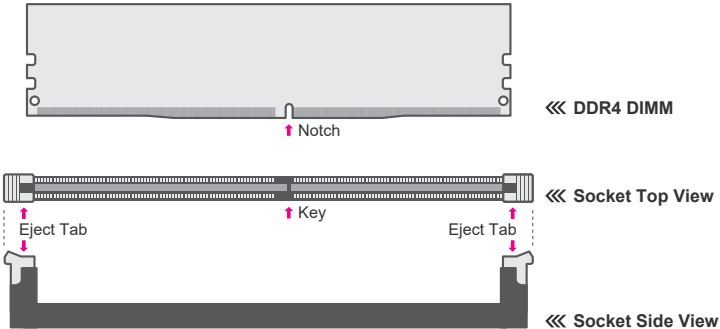

► System Memory ► Installing the DIMM Module

Please follow the steps below to install the memory card into the socket.

Step 1:
Press the eject tabs at both ends of the socket outward and downward to release them from the locked position.

Step 2:
Insert the memory card into the slot while making sure the notch and the key are aligned. Press the card down firmly with fingers while applying and maintaining even pressure on both ends.

Step 3:
The tabs snap automatically to the edges of the card and lock the card in place.

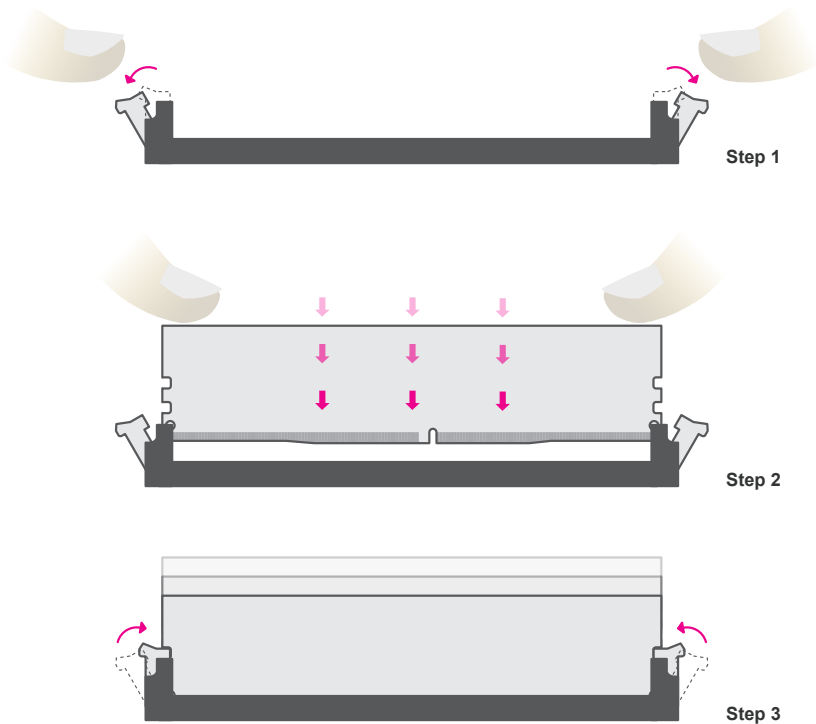

► System Memory

Removing the DIMM Module

Please follow the steps below to remove the memory card from the socket.

Step 1:
Press the eject tabs at both ends of the socket outward and downward to release them from the locked position.

Step 2:
The memory card ejects from the slot automatically.

Step 3:
Hold the card by its edges and remove it from the slot.

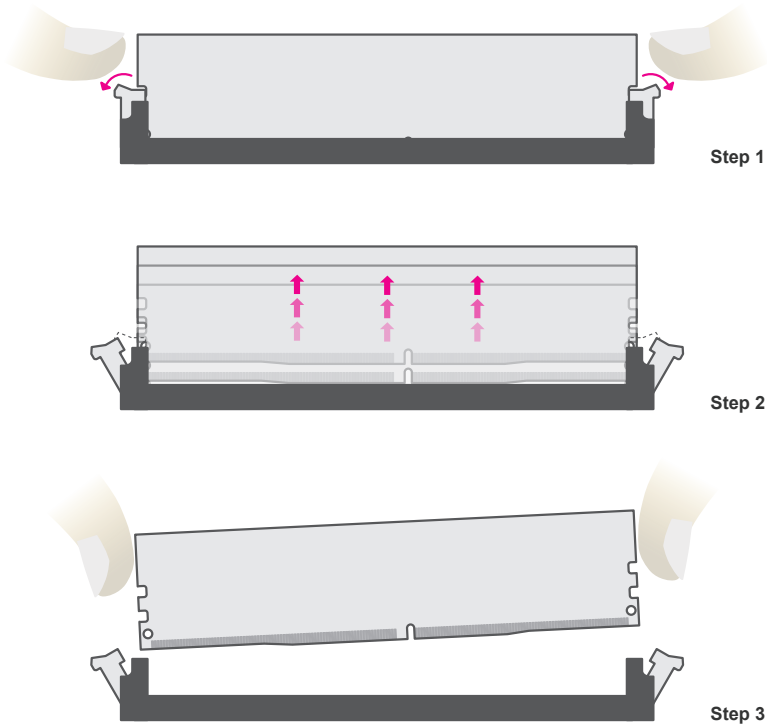

► CPU

The system board is equipped with a surface mount LGA 3647 socket. This socket is exclusively designed for installing a LGA 3647 packaged Intel CPU.



Important:

- 1. Before you proceed, make sure (1) the LGA 3647 socket comes with 2 protective caps, (2) the caps are not damaged and (3) the socket's contact pins are not bent. If the caps are missing or the caps and/or contact pins are damaged, contact your dealer immediately.
- 2. Make sure to keep the protective caps. RMA requests will be accepted and processed only if the LGA 3647 socket comes with the protective caps.

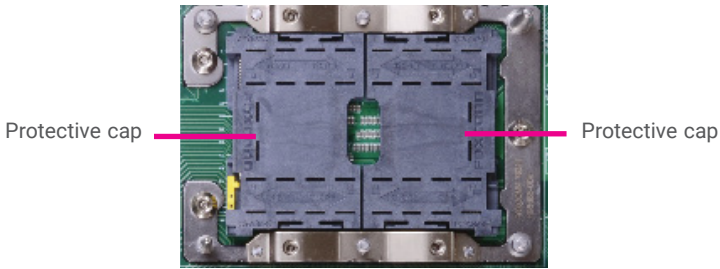

Note:

A boxed Intel® processor already includes the CPU fan and heat sink assembly. If your CPU was purchased separately, make sure to only use Intel®-certified fan and heat sink.

Installing the CPU, Fan and Heat Sink

The CPU must be kept cool by using a CPU fan with heat sink. Without sufficient air circulation across the CPU and heat sink, the CPU will overheat damaging both the CPU and system board.

- 1. Before you place the CPU on the heat sink, you must apply a thermal paste onto the top of the heat sink. The thermal paste is usually supplied when you purchase the fan with heat sink assembly. Do not spread the paste all over the surface. When you later place the CPU on top of the heat sink, the compound will disperse evenly.

Some heat sinks come with a patch of pre-applied thermal paste. Do not apply thermal paste if the fan with heat sink already has a patch of thermal paste on its underside. Peel the strip that covers the paste before you place the CPU on top of the heat sink.

- 2. To insert the CPU into the CPU carrier, please first locate the gold triangular mark on the CPU. The triangular mark must align with the triangular corner of the CPU carrier shown on the photo. Without touching the pins, press the CPU onto the carrier until the CPU is retained by the latches.

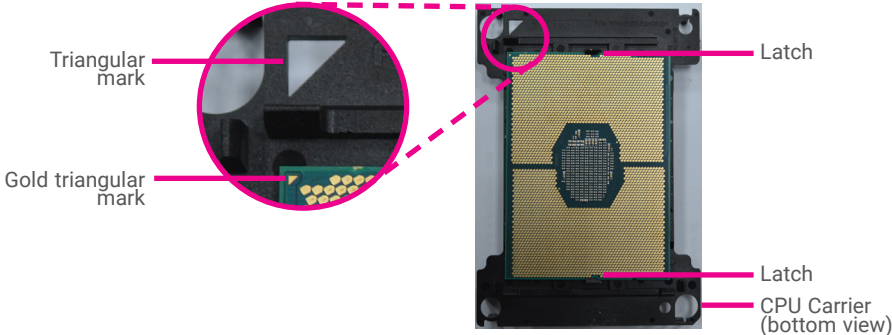
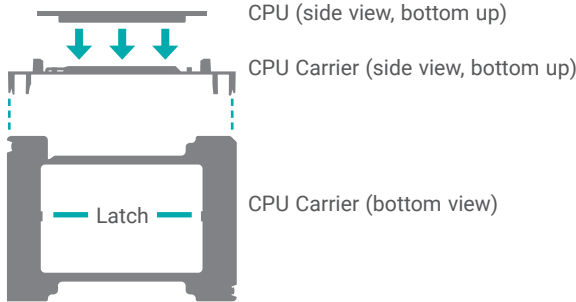

► CPU ► Installing the CPU

3. Place the CPU carrier on top of the heatsink. Place the triangular hole near the mounting hole #1 of the heat sink. Use the push-pins around the CPU carrier to secure the CPU carrier onto the heat sink. You will hear a distinctive “click”, indicating the CPU carrier is correctly locked into position.

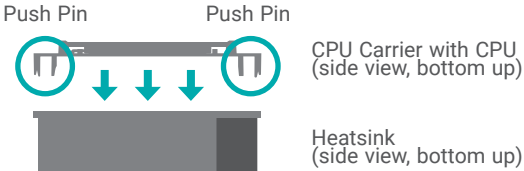

Mounting hole #1 of the heat sink (top view)



Mounting hole #1 (bottom view)
 Triangular hole

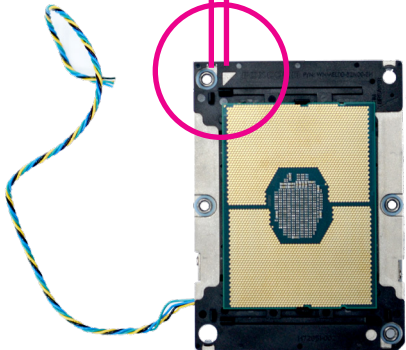

4. Slide the protective caps open and detach them from the board.

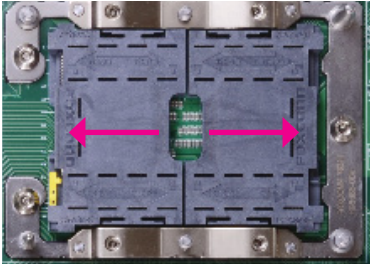

5. Align the triangular mark of the CPU and CPU carrier to the chamfer corner of the CPU and heat sink socket. Place the heatsink assembly on top of the socket. Use the T30 screwdriver to install the assembly according to the sequence of the screws shown on the label.

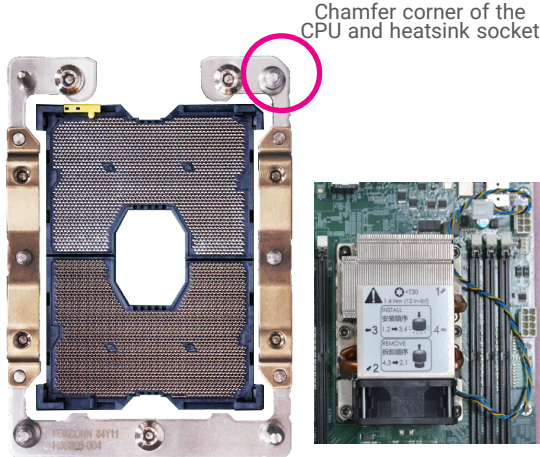

Chamfer corner of the CPU and heatsink socket

6. Connect the CPU fan’s power cable to the CPU fan connector on the system board.

CPU Fan

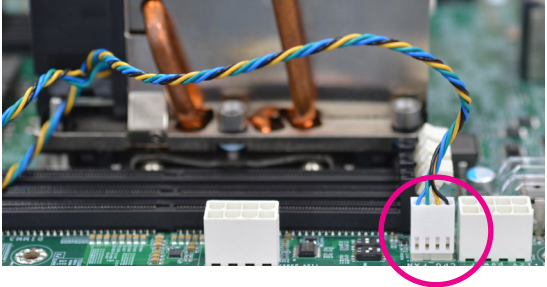
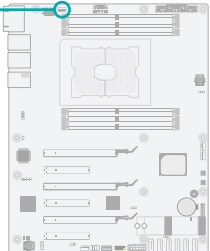

► Jumper Settings

Clear CMOS

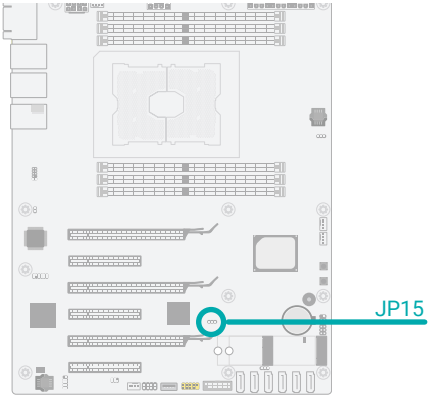

If any anomaly of the followings is encountered –

- a) CMOS data is corrupted;
- b) you forgot the supervisor or user password;
- c) failure to start the system due to BIOS mis-configuration

– it is suggested that the system be reconfigured with default values stored in the ROM BIOS. To load the default values stored in the ROM BIOS, please follow the steps below.

1. Power-off the system and unplug the power cord.
2. Put a jumper cap on pin 2 and pin 3. Wait for a few seconds and set it back to its default setting, i.e. jumper cap on pin 1 and pin 2.
3. Plug the power cord and power-on the system.



■ 1-2 On: Normal (default)



■ 2-3 On: Clear CMOS

ME Firmware Update

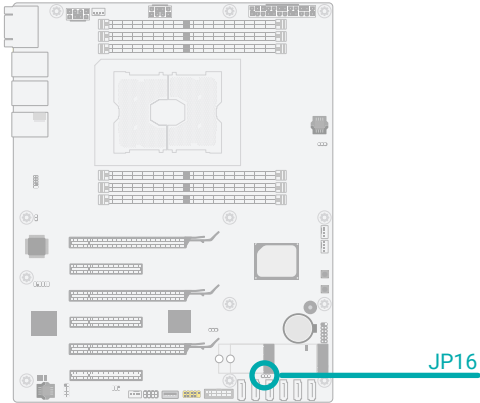

JP16 is used for updating the ME firmware.



■ 1-2 On: Normal (default)



■ 2-3 On: Force ME Update

► Rear I/O Ports

Graphics Display



■ Rear I/O Connectors

◀ I/O Connectors
 ▶ PCB

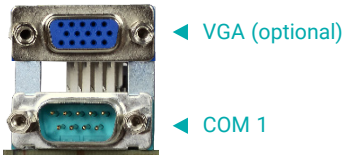

◀ VGA (optional)
 ▶ COM 1



▶ LAN 1
 ▶ LAN 2
 ▶ USB 4 (USB 3.1 Gen 1)
 ▶ USB 3 (USB 3.1 Gen 1)

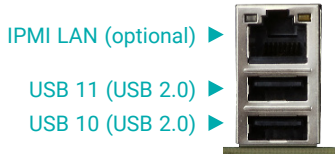

▶ IPMI LAN (optional)
 ▶ USB 11 (USB 2.0)
 ▶ USB 10 (USB 2.0)

Optional VGA (DB15)

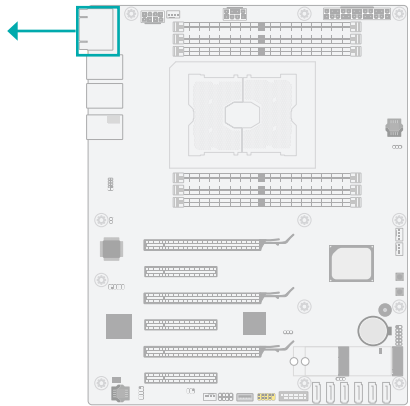
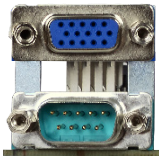

A VGA display port of DB15 connector is available when the motherboard is with IPMI functions and BMC.

VGA Port

The VGA port is used for connecting a VGA monitor. Connect the monitor's 15-pin D-shell cable connector to the VGA port. After you plug the monitor's cable connector into the VGA port, gently tighten the cable screws to hold the connector in place.

▶ Rear I/O Ports

COM (Serial) ports

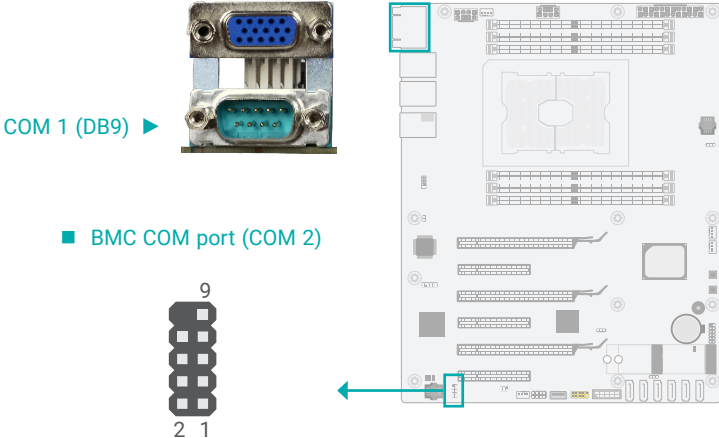

The serial ports are asynchronous communication ports with 16C550A-compatible UARTs that can be used with modems, serial printers, remote display terminals, and other serial devices.

The three COM ports support RS232 – one DB9 connector at the rear side and one internal pin-header connector for monitoring the BMC.

■ COM Port Pin Assignment
 RS232

Pin	DB9	Pin header
1	DCD	DCD
2	SIN	DSR
3	SOUT	RX
4	DTR	RTS
5	GND	TX
6	DSR	CTS
7	RTS	DTR
8	CTS	RI
9	RIN	GND



Note:
 The BMC COM port is used to monitor the IPMI, and may not be present when your model does not support IPMI.

▶ Rear I/O Ports

RJ45 LAN Ports

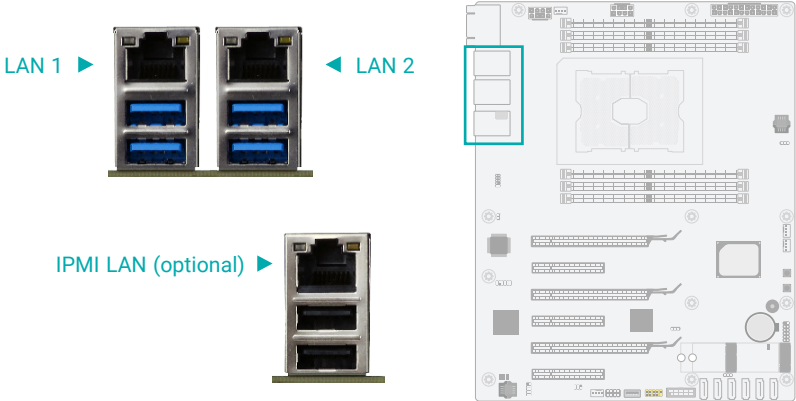

The LAN ports allow the system board to connect to a local area network (LAN) by means of a network hub. The IPMI LAN is only available with IPMI.

Driver Installation
 Install the LAN drivers. Refer to the chapter 4 for more information.

Features

- 2 x Intel® I210AT PCIe (10/100/1000Mbps)
- 1 x RTL8211F only with IPMI

▶ Rear I/O Ports

USB Ports

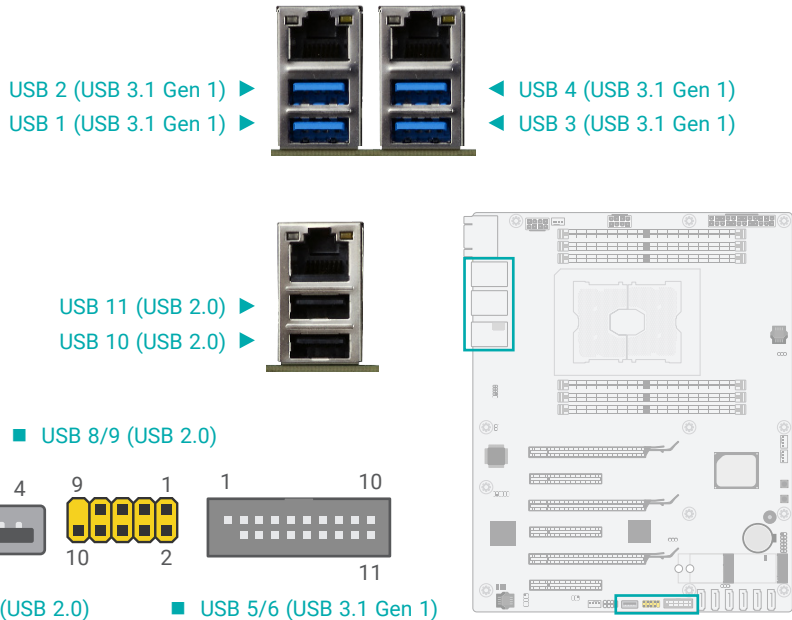

The USB device allows data exchange between your computer and a wide range of simultaneously accessible external Plug and Play peripherals. The system board is equipped with multiple USB ports as listed below:

- 4 x USB 3.1 Gen 1 rear ports (USB 1/2/3/4)
- 2 x USB 3.1 Gen 1 internal ports, box headers (USB 5/6)
- 3 x USB 2.0 internal ports, one pin headers (USB 8/9) and one Type A (USB 7)
- 2 x USB 2.0 rear ports (USB 10/11)

■ USB 2.0 Box Headers

Pin	Assignment	Pin	Assignment
1	VCC	2	VCC
3	D-	4	D-
5	D+	6	D+
7	GND	8	GND
9	KEY	10	N.C.

■ USB 3.1 Box Headers

Pin	Assignment	Pin	Assignment
1	PWR	11	D2+
2	SSRX1-	12	D2-
3	SSRX1+	13	GND
4	GND	14	SSTX2+
5	SSTX1-	15	SSTX2-
6	SSTX1+	16	GND
7	GND	17	SSRX2+
8	D1-	18	SSRX2-
9	D2+	19	PWR
10	N.C.	20	--

The internal USB ports may be mounted on a card-edge bracket. Install the card-edge bracket to an available slot at the rear of the system chassis and then insert the USB port cables to a connector.

Wake-On-USB Keyboard/Mouse

The Wake-On-USB Keyboard/Mouse function allows you to use a USB keyboard or USB mouse to wake up a system from the S3 (STR - Suspend To RAM) state.



Important:

If you are using the Wake-On-USB Keyboard/Mouse function for 2 USB ports, the +5V_standby power source of your power supply must support ≥1.5A. For 3 or more USB ports, the +5V_standby power source of your power supply must support ≥2A.

Internal I/O Connectors

SATA (Serial ATA)

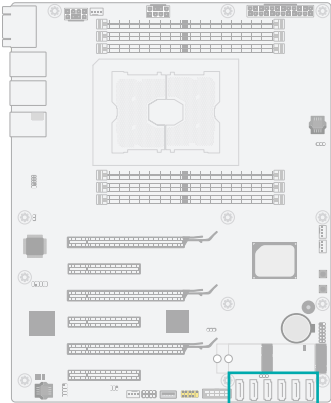

SATA Pin Assignment

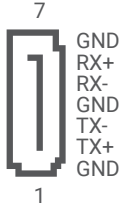

SATA 5/4/3/2/1/0 from left to right

The Serial ATA (SATA) connectors are used to connect the Serial ATA device. SATA 3.0 is supported by the five SATA ports and provides data rate up to 6Gb/s. Connect one end of the Serial ATA cable to a SATA connector and the other end to your Serial ATA device.

Features

- 6 Serial ATA 3.0 ports with data transfer rate up to 6Gb/s
- Integrated Advanced Host Controller Interface (AHCI) controller
- Support RAID 0, RAID 1, RAID 5, RAID 10

Internal I/O Connectors

Front Audio

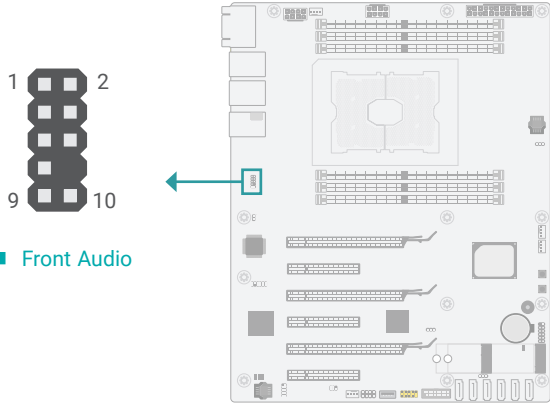

Front Audio

The Front Audio internal connector allows you to connect to audio jacks at the front panel of your system.

Front Audio Pin Assignment

Pin	Assignment	Pin	Assignment
1	Mic-L	2	GND
3	Mic-R	4	N.C.
5	Line-Out-R	6	Mic-JD (sense)
7	GND	8	KEY
9	Line-Out-L	10	Line-JD (sense)

Internal I/O Connectors

Cooling Fan Connectors

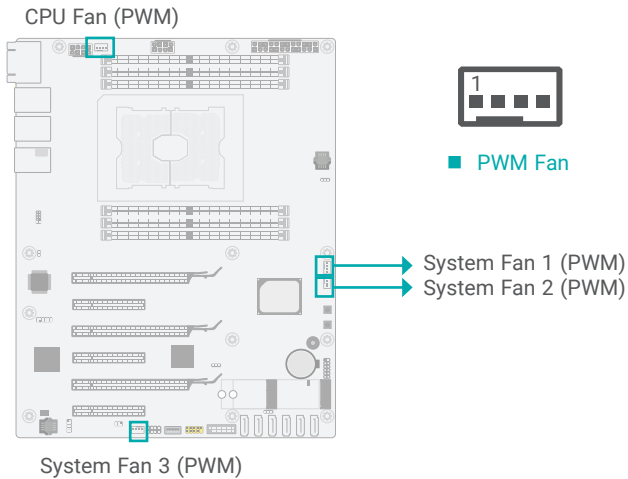

These fan connectors are used to connect cooling fans. The cooling fans will provide adequate airflow throughout the chassis to prevent overheating the CPU and system board components. The 4-pin fans provide PWM to modulate fan speed.

■ 4-pin Fan Pin Assignment

Pin	Assignment
1	Ground
2	Power
3	Sense
4	Speed Control

Internal I/O Connectors

Power Connector

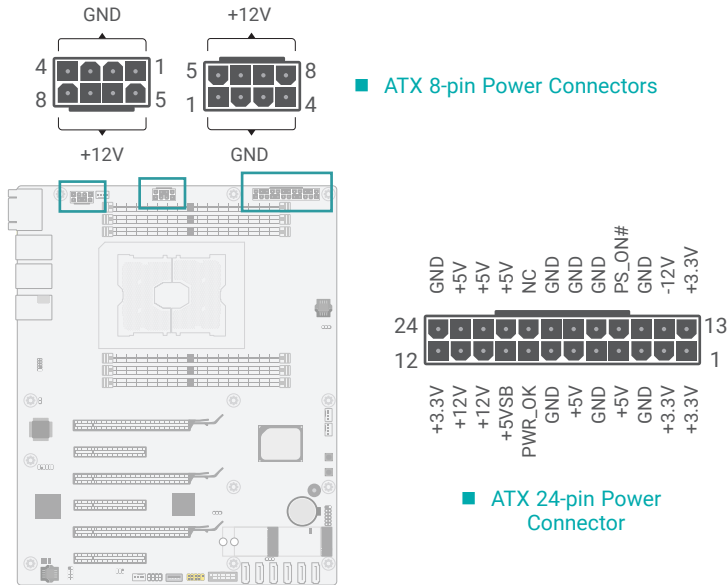

Use a power supply that complies with the ATX12V Power Supply Design Guide Version 1.1. An ATX12V power supply unit has a standard 24-pin ATX main power connector that must be inserted into the 24-pin connector. The 8-pin +12V power connector enables the delivery of more +12VDC current to the processor's Voltage Regulator Module (VRM).

The power connectors from the power supply unit are designed to fit the 24-pin and 8-pin connectors in only one orientation. Make sure to find the proper orientation before plugging the connectors.

The system board requires a minimum of 300 Watt power supply to operate. Your system configuration (CPU power, amount of memory, add-in cards, peripherals, etc.) may exceed the minimum power requirement. To ensure that adequate power is provided, we strongly recommend that the system is supplied with a minimum of 400 Watt power.



Important: Insufficient power supplied to the system may result in instability or malfunction of the add-in boards and peripherals. Calculating the system's approximate power usage is important to ensure that the power supply meets the system's consumption requirements.

Internal I/O Connectors

Chassis Intrusion

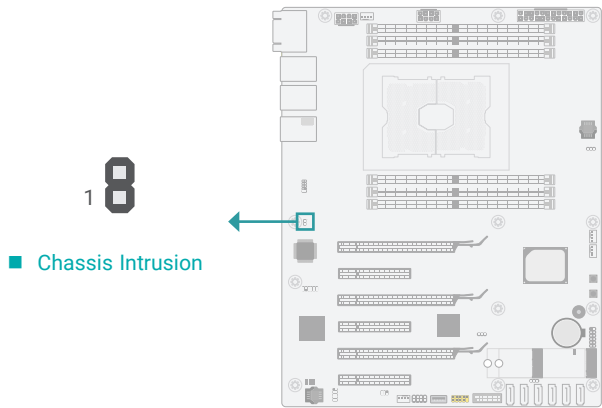

The board supports the chassis intrusion detection function. Connect the chassis intrusion sensor cable from the chassis to this connector. When the system's power is on and a chassis intrusion occurred, an alarm will sound. When the system's power is off and a chassis intrusion occurred, the alarm will sound only when the system restarts.

■ Chassis Intrusion Pin Assignment

Pin	Assignment	Pin	Assignment
1	Signal	2	GND

Internal I/O Connectors

Front Panel

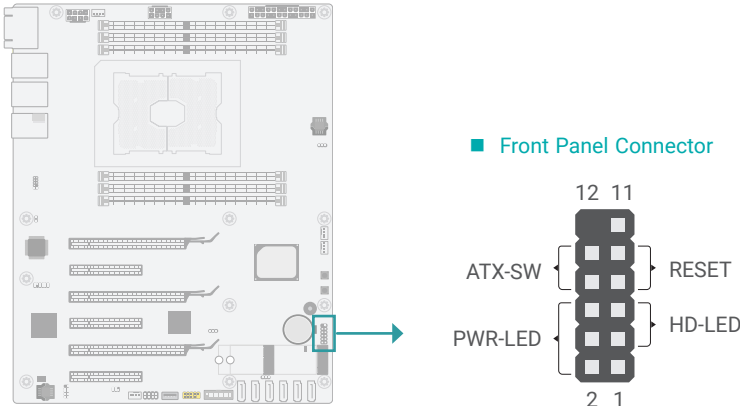

■ Front Panel Pin Assignment

Pin	Assignment	Pin	Assignment		
1	N.C.	2	LED Power		
HD-LED	3	HDD Power	PWR-LED	4	LED Power
	5	Signal	6	Signal	
RESET	7	Ground	ATX-SW	8	Ground
	9	Signal		10	Signal
11	N.C.	12	--		

HDD LED - Hard Disk Drive LED

Lighting of the LED indicates that the hard drive is being accessed.

RESET - Reset Switch

This switch allows you to reboot without having to power off the system.

Power/Standby LED

When the system's power is on, this LED will light up. When the system is in the S1 (POS - Power On Suspend) state, it will blink at 1-second intervals. When the system is in the S3 (STR - Suspend To RAM) state, it will blink at 4-second intervals.

Power Button

This button is used to switch the system's power on or off .

Internal I/O Connectors

Expansion Slots

- a PCIe 1 (PCIe x16; x8 when PCIe 2 in use)
- b PCIe 2 (PCIe x8, shared with PCIe 1)
- c PCIe 3 (PCIe x16; x8 when PCIe 4 in use)
- d PCIe 4 (PCIe x8, shared with PCIe 3)
- e PCIe 5 (PCIe x16; x8 when PCIe 6 in use)
- f PCIe 6 (PCIe x8, shared with PCIe 5)
- g M.2 M Key 2280 (PCIe x4 Gen3/SATA 3.0)
- h M.2 E Key 2230 (PCIe x2 Gen2/USB 2.0)

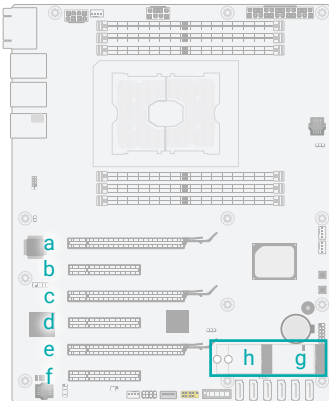

PCI Express x16 Slot

Install a PCI Express x16 graphics card that complies to the PCI Express specifications into the PCI Express x16 slot. To install a graphics card into the x16 slot, align the graphics card to the socket and perpendicularly to the board, be cautious in aligning the locations of notch and key, and then press the card down firmly until it is completely seated. The retaining clip of the slot will close up automatically to hold the graphics card in place.

PCI Express x8 Slots

Install PCI Express cards such as network cards, drives, or other cards that comply to the PCI Express specifications into the PCI Express slots.

M.2 Socket

The M.2 socket is the Next Generation Form Factor (NGFF) which is designed to support multiple modules and make the M.2 more suitable in application for solid-state storage.



Note:
The PCIe x16 slot will automatically switch to x8 bandwidth when the paired PCIe x8 slot is in use.

Internal I/O Connectors Expansion Slots

Installing the M.2 Module

Before installing the M.2 module into the M.2 socket, please make sure that the following safety cautions are well-attended.

1. Make sure the PC and all other peripheral devices connected to it has been powered down.
2. Disconnect all power cords and cables.
3. Locate the M.2 socket on the system board
4. Make sure the notch on card is aligned to the key on the socket.
5. Make sure the standoff screw is removed from the standoff.

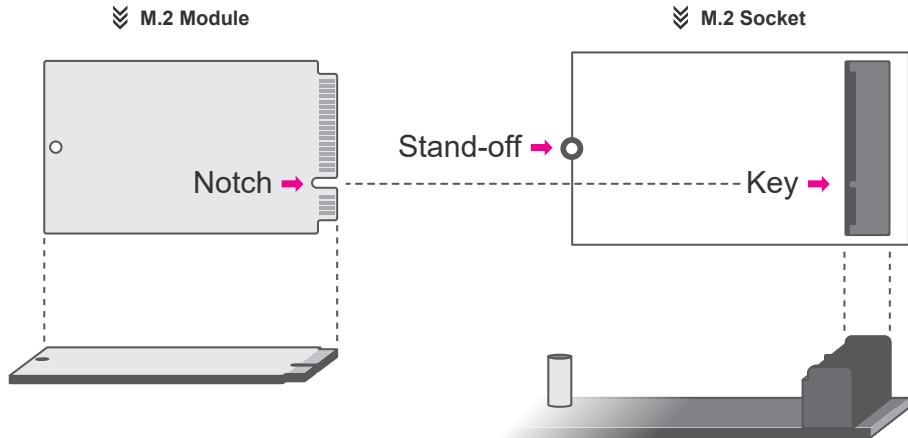

Please follow the steps below to install the card into the socket.

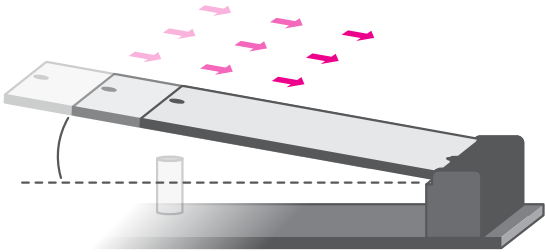

Step 1:
Insert the card into the socket at an angle while making sure the notch and key are perfectly aligned.

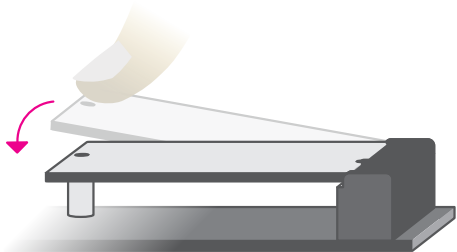

Step 2:
Press the end of the card far from the socket down until against the stand-off.

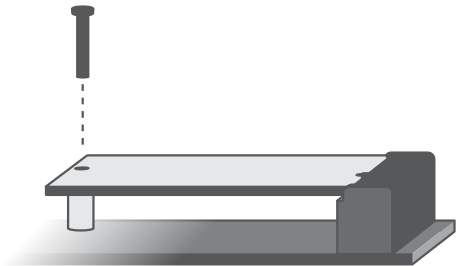

Step 3:
Screw tight the card onto the stand-off with a screw driver and a stand-off screw until the gap between the card and the stand-off closes up. The card should be lying parallel to the board when it's correctly mounted.

LPC

LPC Connector

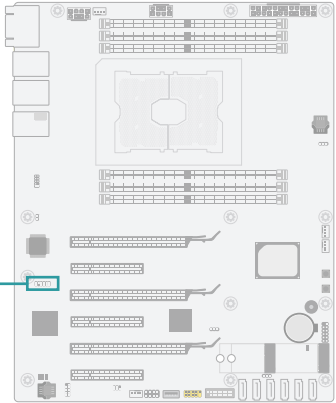

The Low Pin Count Interface was defined by Intel® Corporation to facilitate the industry's transition towards legacy free systems. It allows the integration of low-bandwidth legacy I/O components within the system, which are typically provided by a Super I/O controller. Furthermore, it can be used to interface firmware hubs, Trusted Platform Module (TPM) devices and embedded controller solutions. Data transfer on the LPC bus is implemented over a 4 bit serialized data interface, which uses a 33MHz LPC bus clock. For more information about LPC bus, refer to the Intel® Low Pin Count Interface Specification Revision 1.1'. Pin assignments of the LPC connector are listed in the table below.

LPC Pin Assignment

Pin	Assignment	Pin	Assignment
1	L_CLK	2	L_LAD1
3	L_RST#	4	L_LAD0
5	L_FRAME#	6	3.3V
7	L_LAD3	8	GND
9	L_LAD2	10	---
11	SERIRQ	12	GND

Internal I/O Connectors

Battery

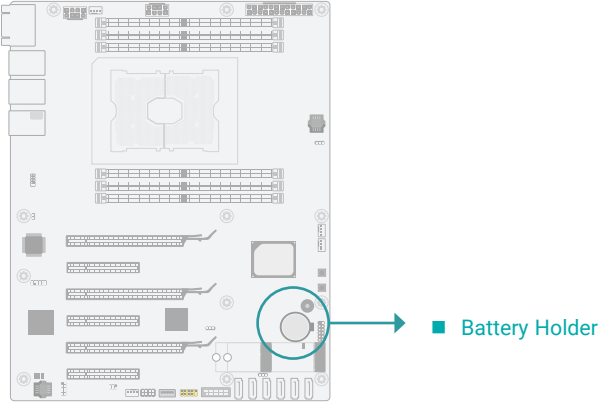

The lithium ion battery addendum supplies power to the real-time clock and CMOS memory as an auxiliary source of power when the main power is shut off. Insert a coin cell battery into the holder and make sure the polarities are correctly oriented – the cap side (rimmed rounded edge) is negative and should be facing the holder; the flat side with a + mark is positive and should be facing away from the holder.

Safety Measures

- There exists explosion hazard if the battery is incorrectly installed.
- Replace only with the same or equivalent type recommended by the manufacturer.
- Dispose of used batteries according to local ordinances.

Internal I/O Connectors

SMBus

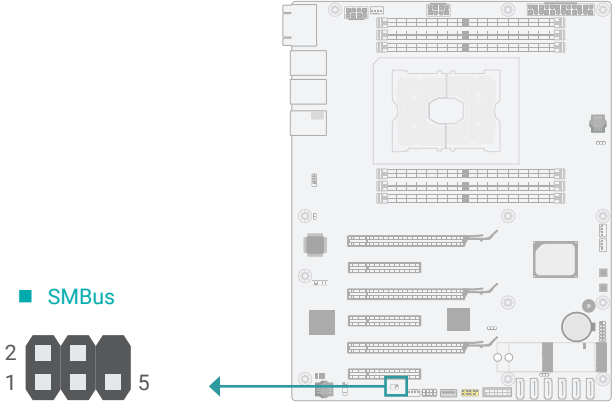

The SMBus (System Management Bus) connector is used to connect the SMBus device. It is a multiple device bus that allows multiple chips to connect to the same bus and enable each one to act as a master by initiating data transfer.

SMBus Pin Assignment

Pin	Assignment	Pin	Assignment
1	3V3SB	2	GND
3	SMBus_Clock	4	SMBus_DATA
5	SMBus_Alert	6	---

► Internal I/O Connectors

JTAG PLD Programming

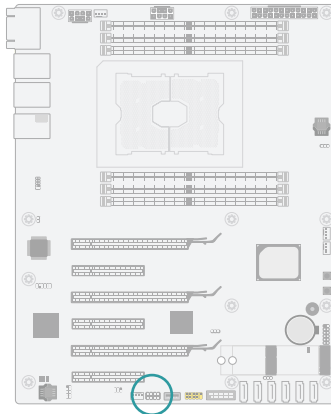

■ JTAG PLD Connector

The JTAG PLD connector is used to verify and test printed circuits.

■ JTAG PLD Pin Assignment

Pin	Assignment	Pin	Assignment
1	3V3SB	2	Test Data Out
3	Test Data In	4	EN N
5	Reset	6	Test Mode Select
7	GND	8	Test Clock

Chapter 3 - BIOS Settings

► Overview

The BIOS is a program that takes care of the basic level of communication between the CPU and peripherals. It contains codes for various advanced features found in this system board. The BIOS allows you to configure the system and save the configuration in a battery-backed CMOS so that the data retains even when the power is off. In general, the information stored in the CMOS RAM of the EEPROM will stay unchanged unless a configuration change has been made such as a hard drive replaced or a device added. It is possible that the CMOS battery will fail causing CMOS data loss. If this happens, you need to install a new CMOS battery and reconfigure the BIOS settings.



Note:

The BIOS is constantly updated to improve the performance of the system board; therefore the BIOS screens in this chapter may not appear the same as the actual one. These screens are for reference purpose only.

Default Configuration

Most of the configuration settings are either predefined according to the Load Optimal Defaults settings which are stored in the BIOS or are automatically detected and configured without requiring any actions. There are a few settings that you may need to change depending on your system configuration.

Entering the BIOS Setup Utility

The BIOS Setup Utility can only be operated from the keyboard and all commands are keyboard commands. The commands are available at the right side of each setup screen. The BIOS Setup Utility does not require an operating system to run. After you power up the system, the BIOS message appears on the screen and the memory count begins. After the memory test, the message "Press DEL to run setup" will appear on the screen. If the message disappears before you respond, restart the system or press the "Reset" button. You may also restart the system by pressing the <Ctrl> <Alt> and keys simultaneously.

Legends

Keys	Function
Right / Left arrow	Move the highlight left or right to select a menu
Up / Down arrow	Move the highlight up or down between submenus or fields
<Enter>	Enter the highlighted submenu
+ (plus key)/F6	Scroll forward through the values or options of the highlighted field
- (minus key)/F5	Scroll backward through the values or options of the highlighted field
<F1>	Display general help
<F2>	Display previous values
<F9>	Optimized defaults
<F10>	Save and Exit
<Esc>	Return to previous menu

Scroll Bar

When a scroll bar appears to the right of the setup screen, it indicates that there are more available fields not shown on the screen. Use the up and down arrow keys to scroll through all the available fields.

Submenu

When "►" appears on the left of a particular field, it indicates that a submenu which contains additional options are available for that field. To display the submenu, move the highlight to that field and press <Enter>.

► Main

The Main menu is the first screen that you will see when you enter the BIOS Setup Utility.

InsydeH2O Setup Utility		Rev. 5.0
Main	Advanced	Security Boot Exit
Project Name	PR611	This is the help for the hour, minute, second field. Valid range is from 0 to 23, 0 to 59, 0 to 59. INCREASE/REDUCE: +/-.
BIOS Version	B198. 15A	
Processor Type	Intel(R) Xeon(R) Silver 4216 CPU @ 2.10GHz	
CPUID	0x50656	
CPU Speed	2100 MHz	
CPU Stepping	CLX N0	
L1 Cache	64 KB	
L2 Cache	102432 KB	
L3 Cache	22528 KB	
Number Of Processors	16 Core(s) / 32 Thread(s)	
Microcode Rev	0x4000029	
Total Memory	4096MB	
System Memory Speed	2400 MHz	
DIMM 1	Not Installed	
DIMM 2	Not Installed	
DIMM 3	Not Installed	
DIMM 4	Not Installed	
DIMM 5	4096 MB	
DIMM 6	Not Installed	
PCH Rev / SKU	LBG QS/PRQ - 1G - S1	
Intel SPS Version / SKU	0A:4.1.4.296	
System Time	[15:35:35]	
System Date	[01/01/2020]	

F1 Help ↑/↓ Select Item F5/F6 Change Values F9 Setup Defaults
Esc Exit ←/→ Select Item Enter Select ► SubMenu F10 Save and Exit

System Date

The date format is <month>, <date>, <year>. Press "Tab" to switch to the next field and press "-" or "+" to modify the value.

System Time

The time format is <hour>, <minute>, <second>. The time is based on the 24-hour military-time clock. For example, 1 p.m. is 13:00:00. Hour displays hours from 00 to 23. Minute displays minutes from 00 to 59. Second displays seconds from 00 to 59.

► Advanced

The Advanced menu allows you to configure your system for basic operation. Some entries are defaults required by the system board, while others, if enabled, will improve the performance of your system or let you set some features according to your preference.



Important:
Setting incorrect field values may cause the system to malfunction.

InsydeH2O Setup Utility		Rev. 5.0
Main	Advanced	Security Boot Exit
<ul style="list-style-type: none"> ►ACPI Configuration ►CPU Configuration ►Video Configuration ►SATA Configuration ►USB Configuration ►PCI Express Configuration ►Debug Configuration ►UEFI Device Manager ►USB Power Control ►SIO NCT6112D ►SIO AST2500 ►H2O IPMI Configuration ►Console Redirection 	ACPI Configuration Setting	

F1 Help ↑/↓ Select Item F5/F6 Change Values F9 Setup Defaults
Esc Exit ←/→ Select Item Enter Select ► SubMenu F10 Save and Exit

► Advanced

RC ACPI Configuration

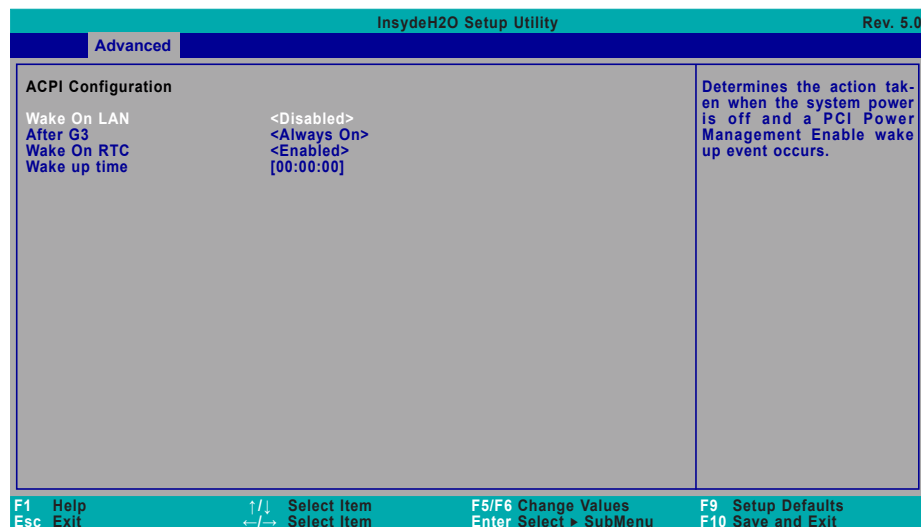

Wake On LAN

Enable or Disable this field to allow LAN signal to power up the system.

After G3

This field is to specify what state the system should be in when power is re-applied after a power failure.

- Always On** The system automatically powers on after power failure.
- Always Off** The system remains power off after power failure. Power-on signal input is required to power up the system.

Wake On RTC

When Enabled, the system will automatically wake up from S4/S5 state at a designated time every day via the Real-time clock (RTC) battery.

[Wake up time]

Configure the time of day the system will wake on RTC – [HH:MM:SS]. This field will only appear when “Wake On RTC” is enabled.

► Advanced

CPU Configuration

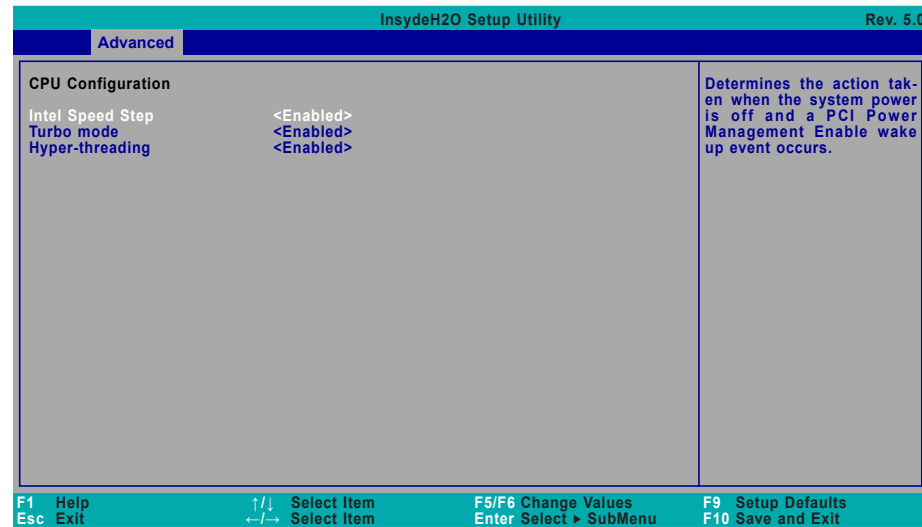

Intel Speed Step

This field is used to enable or disable the Enhanced Intel SpeedStep® Technology (EIST), which helps optimize the balance between system’s power consumption and performance. After it is enabled in the BIOS, EIST features can then be enabled via the operating system’s power management.

Turbo Mode

Enable or disable turbo mode of the processor. This field will only be displayed when “Intel Speed Step” is enabled. This field is not available when the equipped CPU does not support Turbo Mode.

Hyper-threading

Enable or disable Hyper-threading. When it is enabled, a physical core will perform as two logical processors, and the user may experience better computational efficiency of the system. Please make sure that the OS operating on your system is optimized for Hyper-Threading, e.g. Windows and Linux. This field is not available when the equipped CPU does not support Hyper-threading.



Note:
Some of the fields may not be available when the features are not supported by the equipped CPU.

▶ **Advanced**

Video Configuration

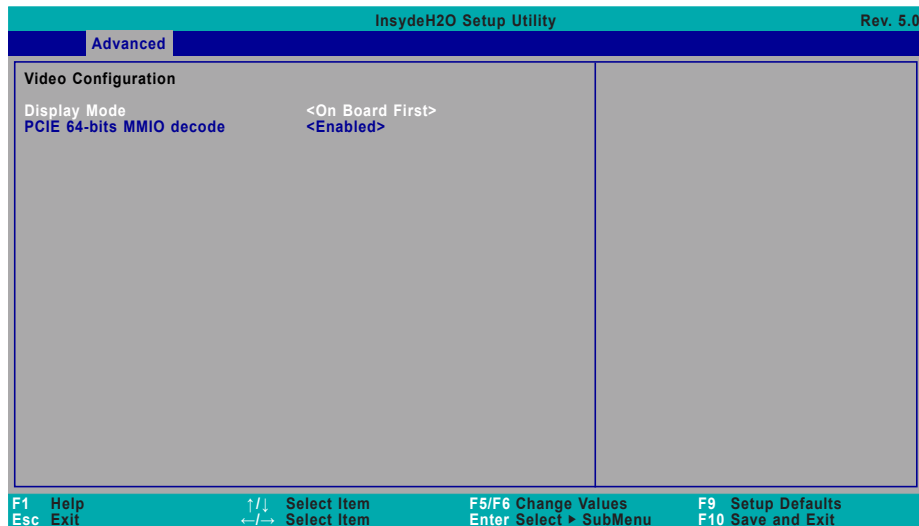

Display Mode

Select among On Board First and Plug In First to specify the display I/O source.

PCIe 64-bits MMIO decode

Select Enabled or Disabled to allocate MMIO resource of PCIe VGA card at 64-bits address. Enable it for specific VGA card that need huge resource. But it may cause VGA card to not display during boot in dual/legacy mode.

▶ **Advanced**

SATA Configuration

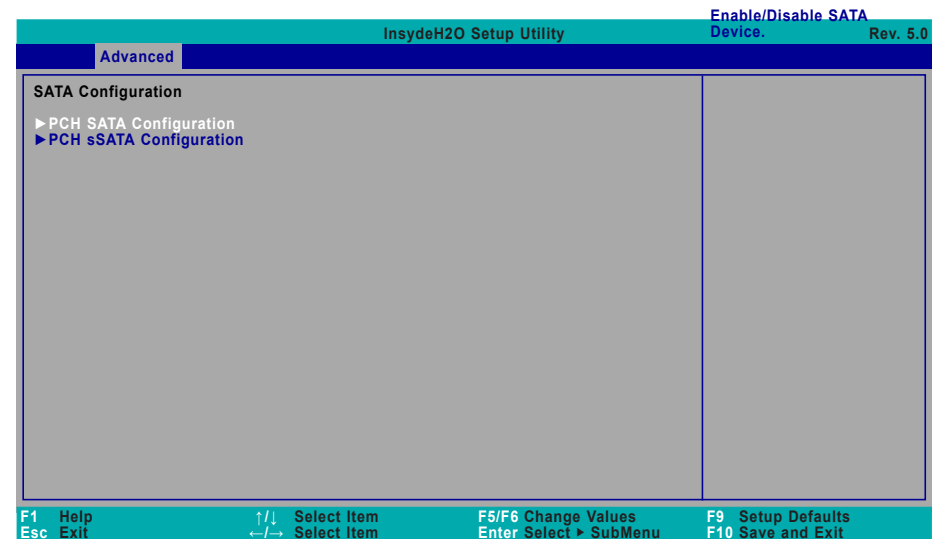

▶ **PCH SATA Configuration**

Press Enter to enter the sub-menu and configure on-board SATA 3.0 controllers.

▶ **PCH sSATA Configuration**

Press Enter to enter the sub-menu and configure the M.2 SATA storage device.

▶ Advanced ▶ SATA Configuration

▶ PCH SATA Configuration

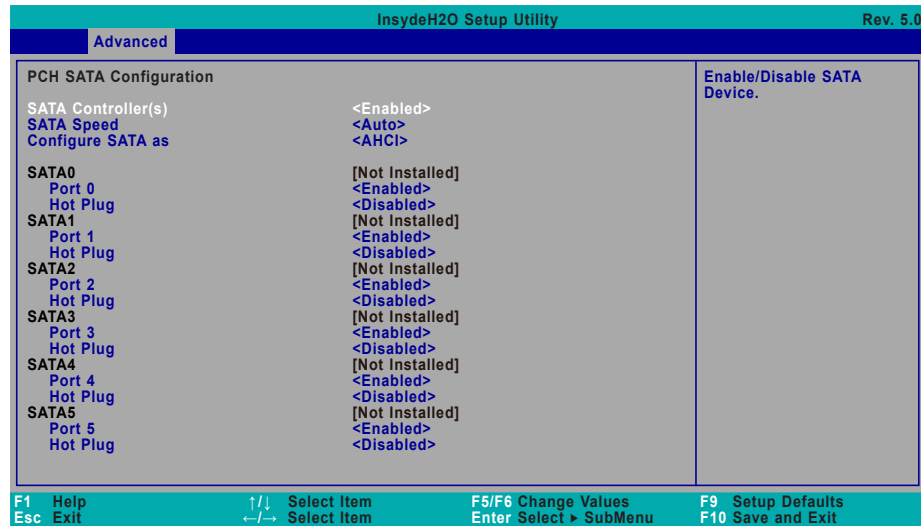

SATA Controller(s)

Enable or disable the Serial ATA controller. This following fields will only be displayed when this field is enabled.

SATA Speed

Select Serial ATA controller(s) speed – Auto, Gen1 (1.5 Gbit/s), Gen2 (3 Gbit/s) or Gen 3 (6 Gbit/s).

SATA Mode Selection

The mode selection determines how the SATA controller(s) operates.

- AHCI** This option allows the Serial ATA controller(s) to use AHCI (Advanced Host Controller Interface).
- RAID** This option allows the Serial ATA controller(s) to use UEFI, RAID, and Intel Rapid Storage Technology.

SATA Port 0-5/Hot Plug

Enable or disable each Serial ATA port and its hot plug function.

▶ Advanced ▶ SATA Configuration

▶ PCH sSATA Configuration

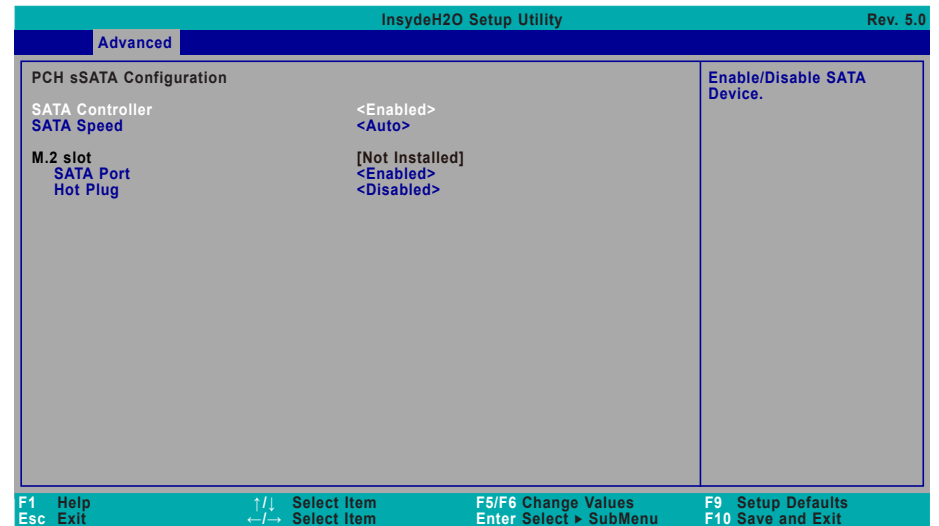

SATA Controller

Enable or disable the Serial ATA controller. This following fields will only be displayed when this field is enabled.

SATA Speed

Select Serial ATA controller(s) speed – Auto, Gen1 (1.5 Gbit/s), Gen2 (3 Gbit/s) or Gen 3 (6 Gbit/s).

SATA Port / Hot Plug

Enable or disable each Serial ATA port and its hot plug function.

▶ Advanced

USB Configuration

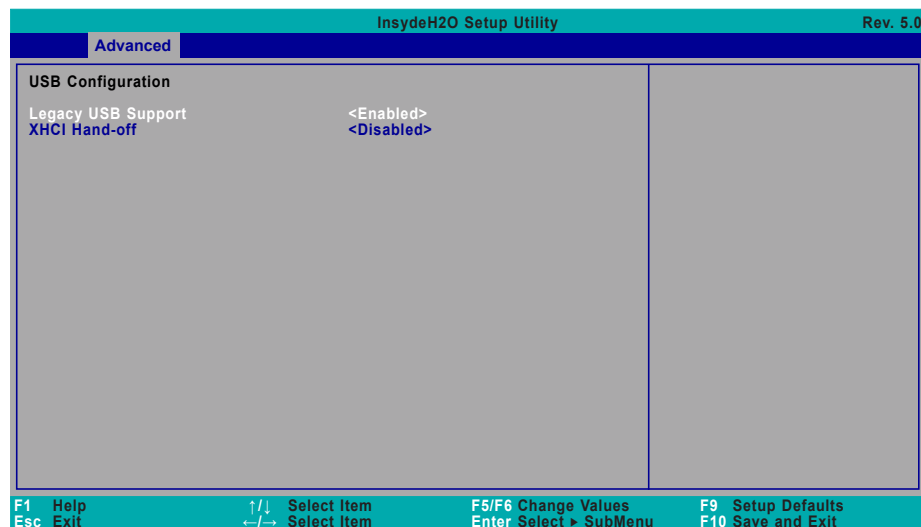

Legacy USB Support

- Enabled** Enable Legacy USB support.
- Disabled** Keep USB devices available only for EFI applications.

XHCI Hand-off

Enable or disable XHCI Hand-off.

▶ Advanced

PCI Express Configuration

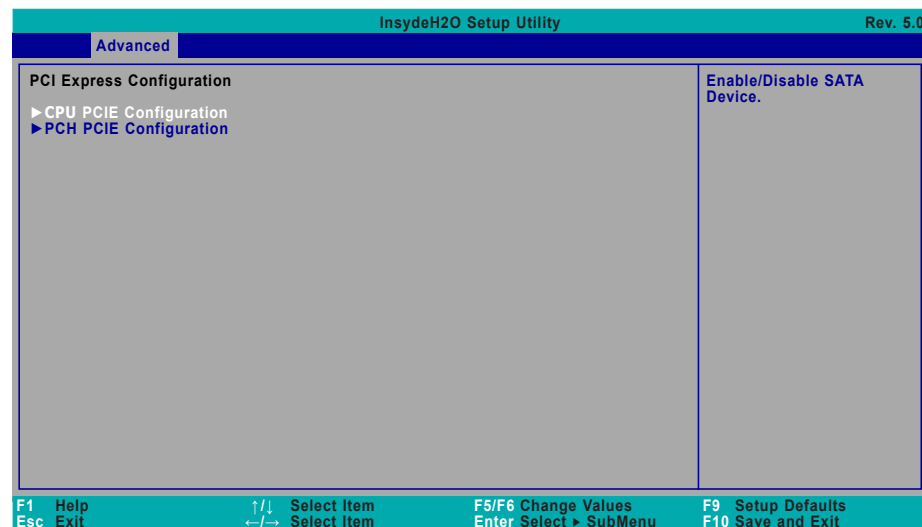

▶ **CPU PCIE Configuration**

Press Enter to enter the sub-menu and configure the PCIE ports — PCIE1, PCIE2, PCIE3, PCIE4.

▶ **PCH PCIE Configuration**

Press Enter to enter the sub-menu and configure the PCIE devices — LAN1, LAN2, and M.2 slot.

▶ **PCIE1/PCIE2/PCIE3/PCIE4/LAN1/LAN2/M.2 slot**

Port Enable

Enable or disable the PCI Express Root Port.

PCIe Speed

Select PCIe Speed of the current port — AUTO, Gen1 (2.5 GT/s), Gen2 (5 GT/s), or Gen3 (8 GT/s). Gen 3 is only available for the PCIE1 port. This field may not appear when the speed of the port is not configurable.

Hot Plug

Enable or disable hot plug function of the port. This field may not appear when the port does not support hot plug.

► Advanced

Debug Configuration

This section configures Debug setting.

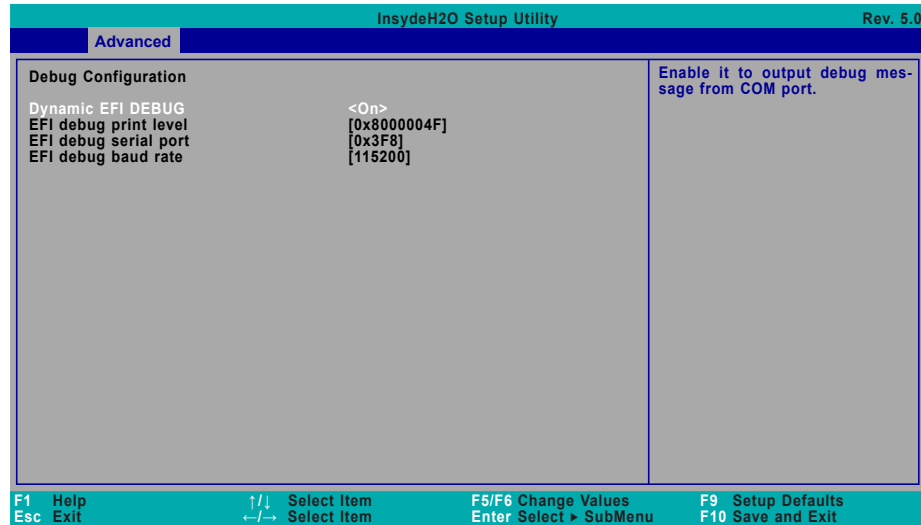

Dynamic EFI DEBUG

This field is used to turn on or off the function to output debug message from COM port. When this field is set to "On", the following EFI debug configurations will be displayed.

EFI debug print level

Default value is 0x8000004F.

EFI debug serial port

Default value is 0x3F8.

EFI debug baud rate

Default value is 115200.

► Advanced

UEFI Device Manager

Configure UEFI device with option ROM, such as LAN card, etc.

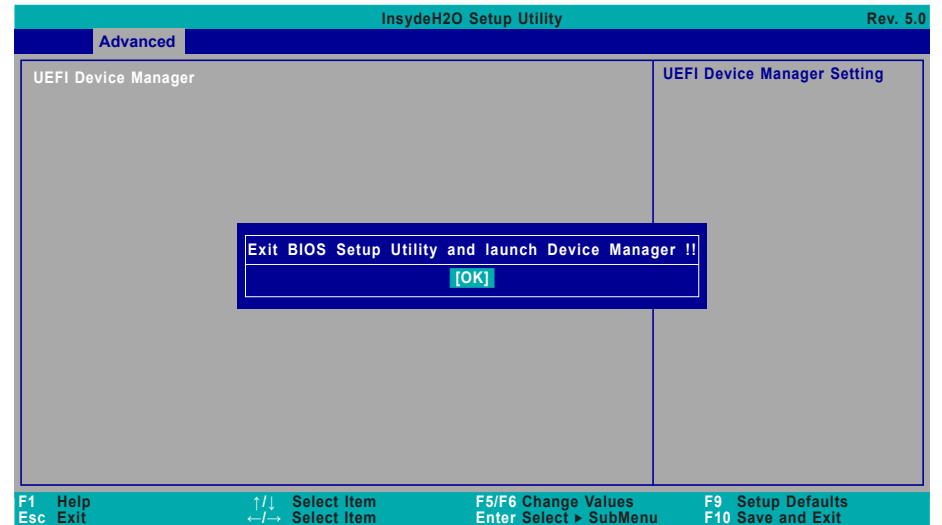

Press "Enter" and "OK" to enter UEFI Device Manager setup page. More device settings can be configured in the UEFI Device Manager, including LAN, Network Stacks, and etc.



Note:

Network Device will not be configurable in Device Manager if "Network Stack" is disabled in the "Boot" menu.

► **Advanced**

USB Power Control

Configure USB power output between 5V and 5V_Dual.

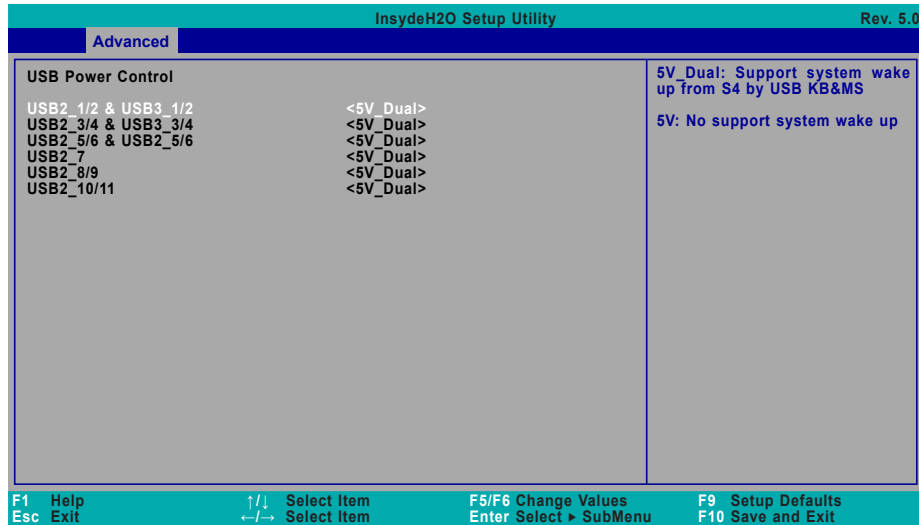

5V_Dual

Support system wake up from S4 by USB keyboard & mouse.

5V

Doesn't support system wake up.

► **Advanced**

SIO NCT6112D

Configure Super I/O settings in this submenu. Scroll by moving the cursor up or down to reveal more options.

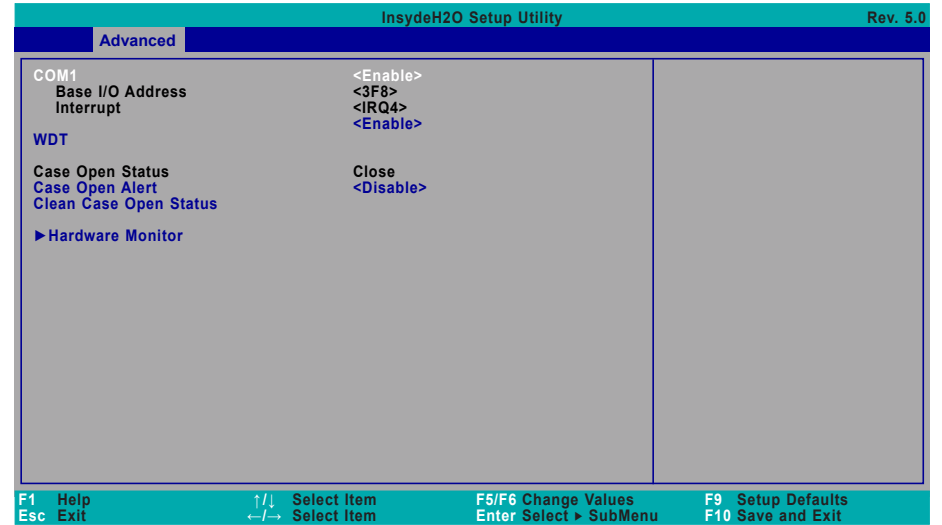

COM1 / COM2

Enables or disables the serial ports (COM). The following bracketed fields will only appear when the port is enabled.

WDT

Enable or disable the Watchdog Timer (WDT) function. A counter will appear if you select to enable WDT. Input any value between 1 to 255 seconds.

▼ **WDT = [Enable]**

Counter

Set the timeout value of the WDT – 1-255 seconds.

Case Open Alert

Enable or disable case open alert.

Clean Case Open Status

Clean current case open status including alert.

▶ Advanced ▶ SIO NCT6112D

▶ **Hardware Monitor**

This section displays the PC health status.

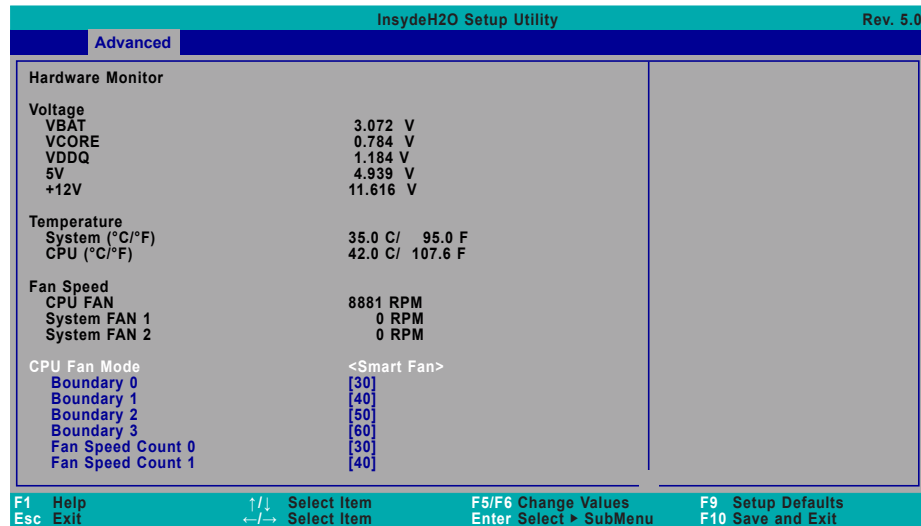

Smart Fan

Smart Fan is a fan speed moderation strategy that depends on the current system temperature. When the system temperature goes higher than the Boundary setting, the fan speed will be turned up to the setting of the Fan Speed Count that bears the same index as the Boundary field.

SYS Smart Fan/CPU Smart Fan Control

Enable or disable the system smart fan. When disabled, fan speed will not be controllable according to different system temperatures. Instead, a Fix Fan Speed Count field will be displayed to configure at which speed the fan will always be fixed regardless of system temperature.

▼ **CPU / Sytem Fan Mode = [Smart Fan]**

Boundary 0 to Boundary 3

Set the boundary temperatures that determine the fan speeds accordingly, the value ranging from 0-127°C. For example, when the system temperature reaches Boundary 1 setting, the fan speed will be turned up to the designated speed of the Fan Speed Count 1 field.

Fan Speed Count 0 to Fan Speed Count 3

Set the fan speed, the value ranging from 1-100%, 100% being full speed. The fans will operate according to the specified boundary temperatures above-mentioned.

▼ **CPU / Sytem Fan Mode = [Manual]**

Fan Speed Count

Set the fan speed, the value ranging from 1-100%, 100% being full speed. The fans will always operate at the specified speed regardless of gauged temperatures.

► Advanced

SIO AST2500/AST2510

View the super I/O settings in this submenu.

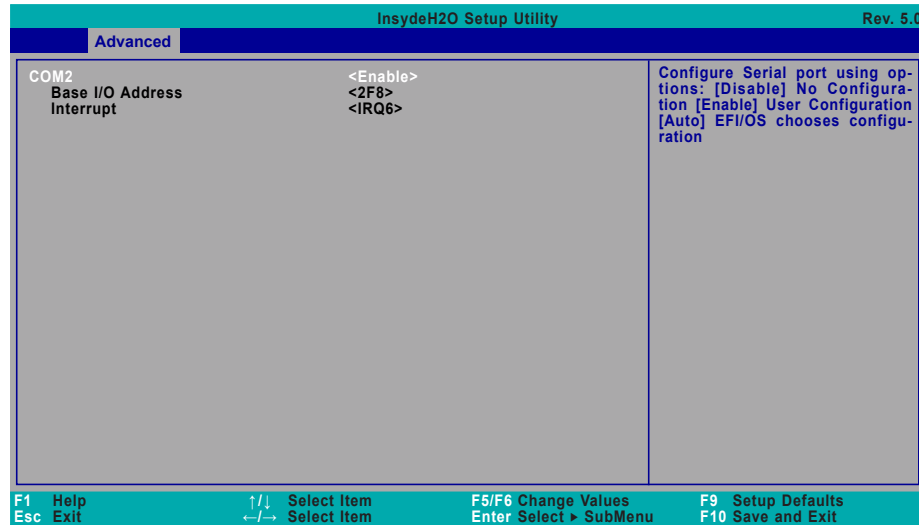

COM2

Enables or disables the serial ports (COM). The following bracketed fields will only appear when the port is enabled.



Note:
SIO AST2500/AST2510 is only present when the board supports the IPMI functions and equipped with SEM2500/SEM2510.

► Advanced

H2O IPMI Configuration

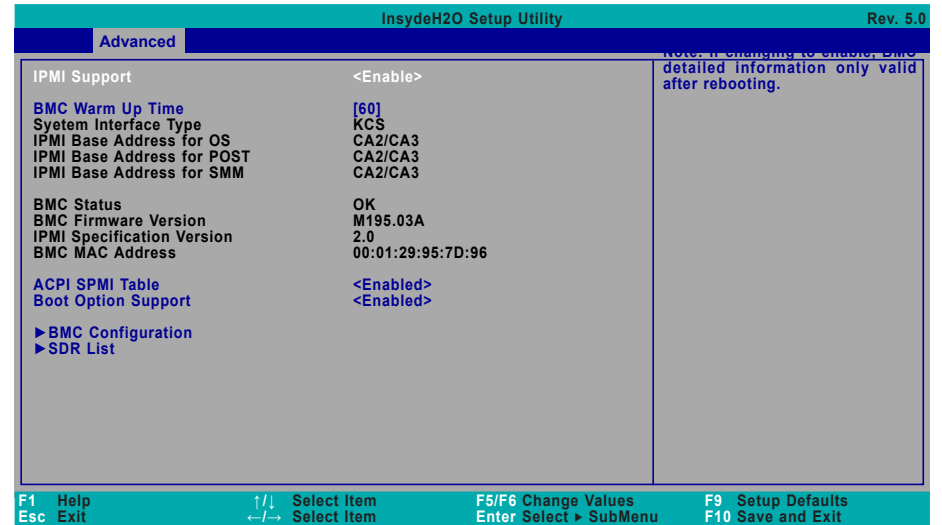

IPMI Support

Enable or disable the IPMI functions. When it is set to "Enable", BMC detailed information will only be valid after reboot.

BMC Warm Up Time

Insert a value from 0 to 240 (seconds) to specify the maximum waiting time from POST to BMC ready.

ACPI SPMI Table

Enable or disable this field for IPMI driver installation.

Boot Option Support

Enable or disable IPMI boot option function.

▶ Advanced ▶ H2O IPMI Configuration

▶ BMC Configuration

Configure the BMC related settings in this sub-menu.

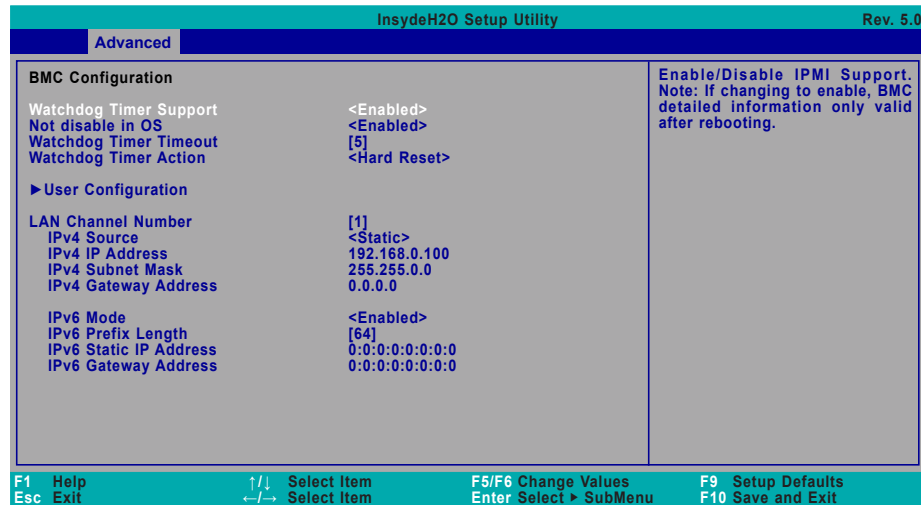

Watchdog Timer Support

Enable or disable the BMC's Watchdog Timer (WDT) function at the start of POST. The following fields will be configurable when this field is enabled.

Not disable in OS

Keep WDT enabled when boot in OS.

Watchdog Timer Timeout

Enter the number of minutes the system firmware has to boot the OS before it takes the Timeout Action. Valid values are from 2 to 8 minutes.

Watchdog Timer Action

Select which timeout action shall be carried out when the WDT is up – No Action, Hard Reset, Power Down, or Power Cycle.

LAN Channel Number

BMC's LAN channel number. There are three channels available – channel number from 1 to 3. To configure a LAN channel, insert a channel number, and the IP settings of the selected channel will be listed in the following.

IPv4 Source

Select how BMC IPv4 settings are configured: automatically (DHCP) or manually (Static).

IPv4 IP Address

Enter the BMC IPv4 IP address. This field is only required when using Static IP.

IPv4 Subnet Mask

Enter the BMC IPv4 Subnet Mask. This field is only required when using Static IP.

IPv4 Gateway Address

Enter the BMC IPv4 Gateway Address. This field is only required when using Static IP.

IPv6 Mode

Enable or disable Internet Protocol v6 (IPv6).

IPv6 Prefix Length

Set IPv6 prefix length.

IPv6 Static IP Address

Enter the BMC IPv6 IP Address.

IPv6 Gateway Address

Enter the BMC IPv6 Gateway Address.

▶ Advanced ▶ H2O IPMI Configuration

▶ BMC Configuration ▶ User Configuration

Configure the BMC's users in this sub-menu. The settings of all the 15 users are listed in the lower part of the sub-menu.

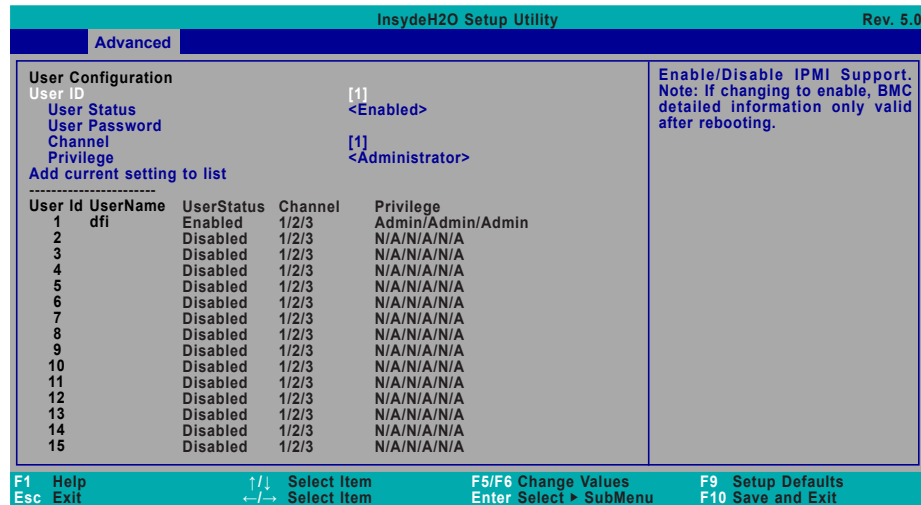

User ID

There are 15 BMC users available per system. Insert a number from 1 to 15 to select which user ID is to be configured.

User Name

Insert an alias for the currently selected user.

User Status

Enable or disable the currently selected user.

User Password

Set up a password for the currently selected user. To clear any previously configured password, press **Enter** and leave the new password empty.

Channel

Select a LAN Channel to configure the privilege of the currently selected user.

Privilege

Select among Reserved, Callback, User, Operator, Administrator, and No Access. The privilege of a user ID can be set differently in different channels.

Add current setting to list

Save the setting of the current user ID's privilege of the current channel.

▶ Advanced ▶ H2O IPMI Configuration

▶ SDR List

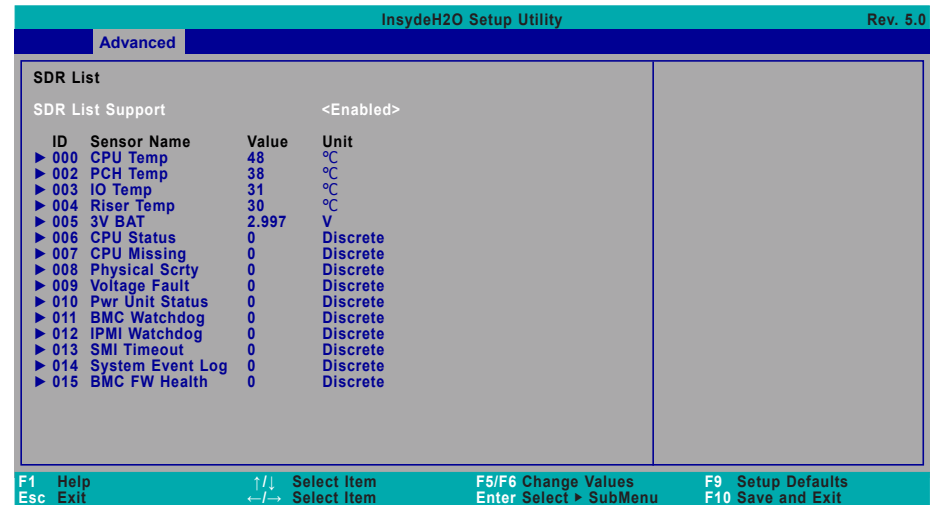

SDR List Support

Enable or disable the Sensor Data Record (SDR). All recorded information is listed in the lower part of the page.

► Advanced

Console Redirection

Configure COM port serial settings in the submenu.

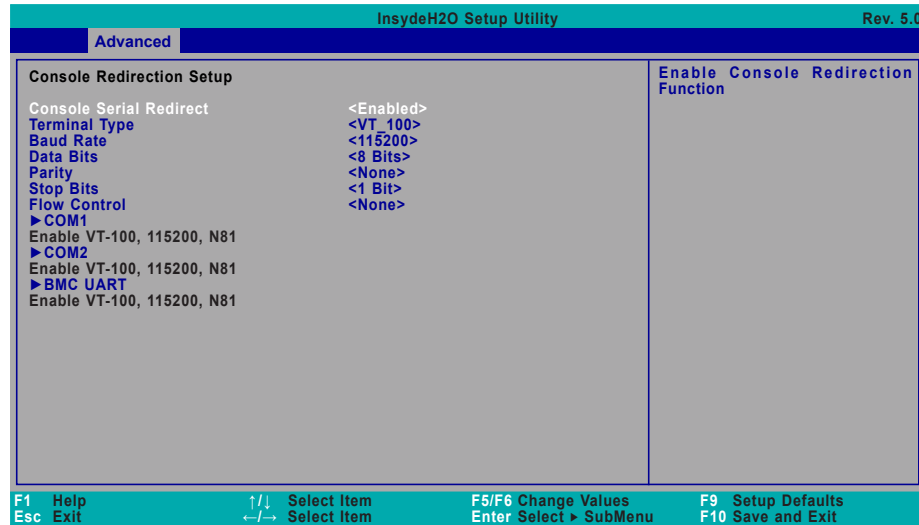

Terminal Type

Select terminal type – VT_100, VT_100+, VT_UTF8 or PC_ANSI.

Baud Rate

Select baud rate – 115200, 57600, 38400, 19200, 9600, 4800, 2400 or 1200.

Data Bits

Select data bits – 7 bits or 8 bits.

Parity

Select parity bits – none, even or odd.

Stop Bits

Select stop bits – 1 bit or 2 bits.

Flow Control

Select flow control type – none, RTS/CTS or XON/XOFF.

► COM1/COM2/BMC UART

Configure individual COM port serial settings in the submenu.

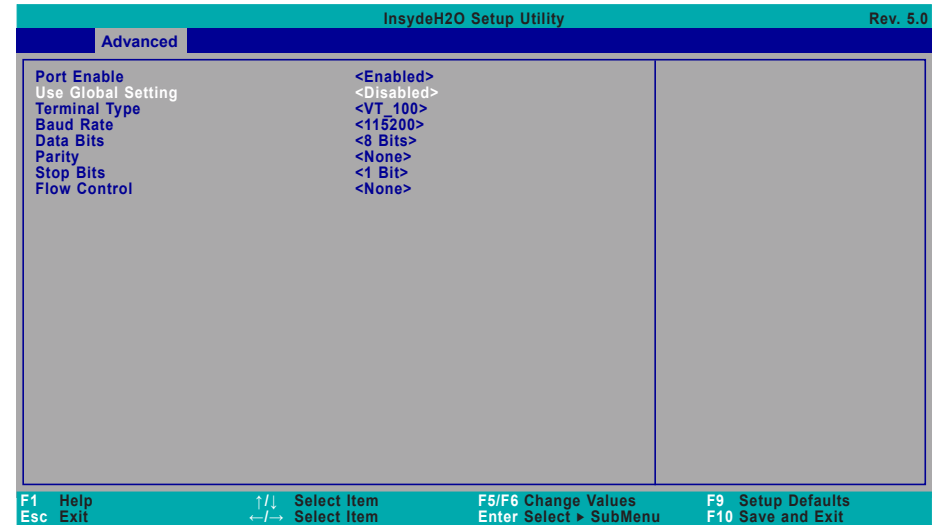

Port Enable

This field is used to enable or disable the COM port to redirect the console.

Use Global Setting

This field is to enable or disable using the global setting. When "Use Global Setting" is enabled, settings of the current port will dependent on Console Redirection settings. When "Use Global Setting" is disabled, settings of the current port can be configured independently in this section.

► Security

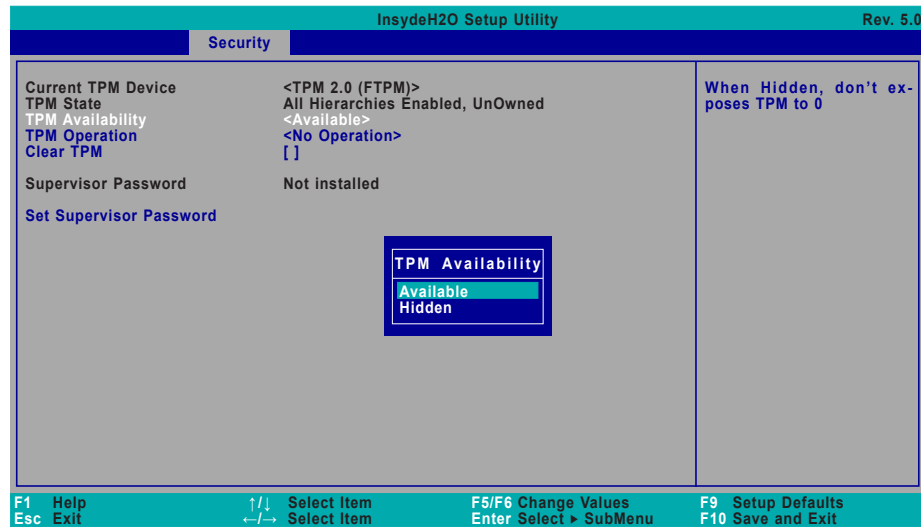

TPM Availability

Show or hide the TPM availability and its configurations.

TPM Operation

Select one of the supported operation to change TPM2 state – No Operation, Enable, or Disable.

Clear TPM

Remove all TPM context associated with a specific Owner.

Set Supervisor Password

Set the supervisor's password. The length of the password must be greater than one character.



Note:
The devices shown here are based on a carrier board that may not resemble your actual carrier board. The actual I/O devices depend entirely on those present on your actual carrier board.

► Boot

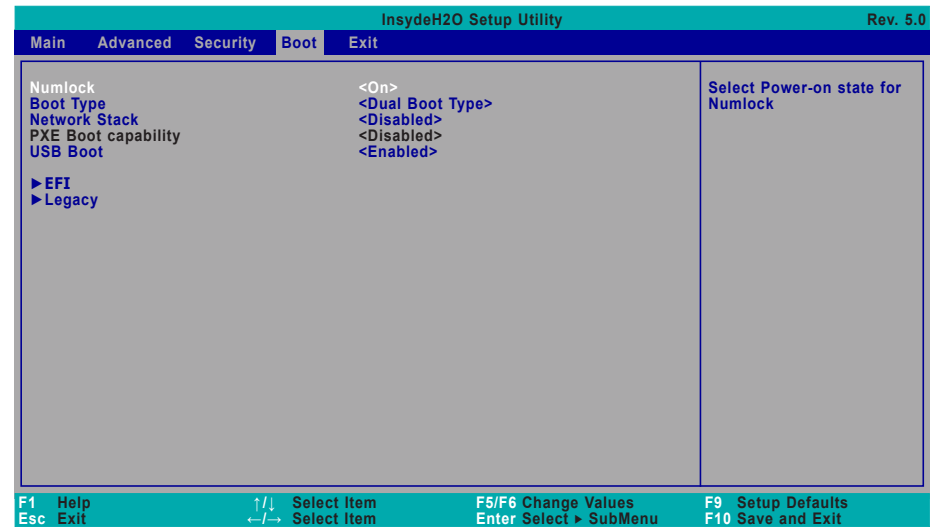

Numlock

Select the power-on state for numlock.

Boot Type

Select the boot type – UEFI Boot Type, Legacy Boot Type or Dual Boot Type. If you select “UEFI Boot Type” or “Dual Boot Type”, the “Network Stack”, “PXE Boot capability”, “USB Boot” and “Quiet Boot” will show up. If you select “Legacy Boot Type”, “PXE Boot to LAN”, “USB Boot” and “Quiet Boot” will show up.



Note:
Please press F10 to save the settings and re-start the system board after changing "Boot Type".

Network Stack

This field is used to enable or disable network stacks, i.e. IPv4 or IPv6 network protocols.

► **Boot**

PXE Boot capability

This field is only available when "Boot Type" is set to "UEFI Boot Type" or "Dual Boot Type", and when "Network Stack" is enabled.

- Disabled** Support Network Stack
- UEFI** IPv4/IPv6
- Legacy** Legacy PXE OPRM only

PXE Boot to LAN

Enable or disable Boot into the Pre-boot Execution Environment (PXE) stored in the LAN. This field is only available when "Boot Type" is set to "Legacy Boot Type" or "Dual Boot Type", and when "Network Stack" is enabled.

USB Boot

Enable or disable booting to USB boot devices.

Quiet Boot

Enable or disable booting in text mode.

► **EFI/Legacy**

Configure boot priorities in this submenu. Re-arrange the order by pressing +/- or F5/F6 to move the highlighted item down/up the priority list. This field is only available when the system detects any boot device.

Normal Boot Menu

Select a priority arranging method.

- Normal** Boot priority is arranged according to the type of the storage devices, and the configured order.
- Advance** Boot priority is arranged according to the configured order regardless of the type of the storage devices.

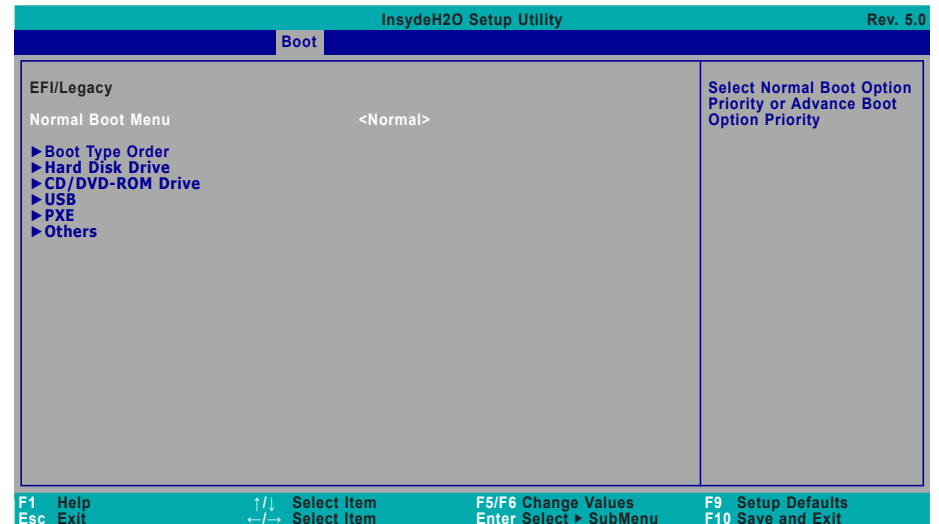

► **Boot Type Order**

Arrange the priority of types of the storage devices.

► **Hard Disk Drive/ ►CD/DVD-ROM Drive / ►USB / ►PXE / ►Others**

Arrange the priority of the storage devices in each category. The submenu will not be displayed when there is no available storage device of the type.



Note:

When a desired LAN port for PXE boot is not listed as a boot device, please confirm that the "PXE Boot to LAN", "PXE boot capability", "Network Stack" and the LAN controller of the said LAN (go to "Advanced" > "PCI Express Configuration") are enabled. Please press F10 to save the settings and re-start the system board for the settings to take effect.

► **Exit**

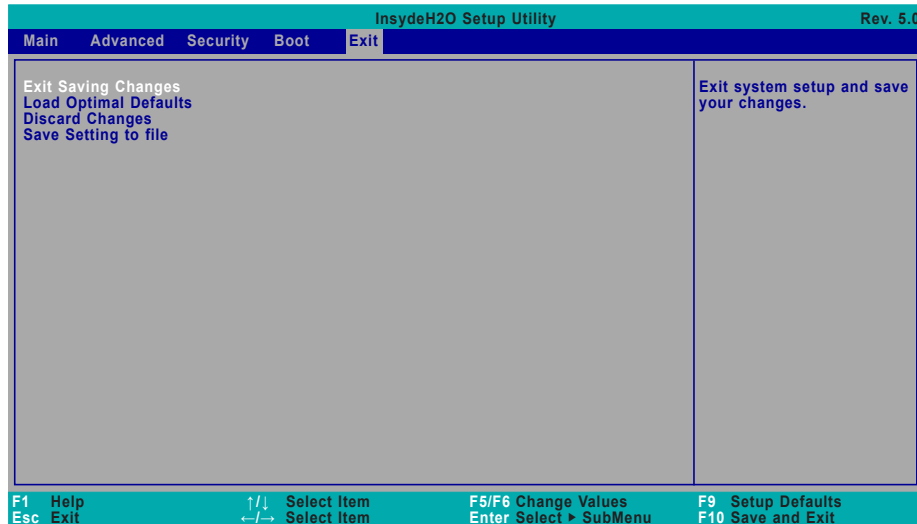

Exit Saving Changes

Select Yes and press <Enter> to exit the system setup and save your changes.

Load Optimal Defaults

Select YES and press <Enter> to load optimal defaults.

Discard Changes

Select YES and press <Enter> to exit the system setup without saving your changes.

Save Setting to file

Select this option to save BIOS configuration settings to a USB flash device.

► **Updating the BIOS**

To update the BIOS, you will need the new BIOS file and a flash utility. Please contact technical support or your sales representative for the files and specific instructions about how to update BIOS with the flash utility. For updating Insyde BIOS in UEFI mode, you may refer to the how-to video at <https://www.dfi.com/tw/knowledge/video/31>.

► **Notice: BIOS SPI ROM**

1. The Intel® Management Engine has already been integrated into this system board. Due to the safety concerns, the BIOS (SPI ROM) chip cannot be removed from this system board and used on another system board of the same model.
2. The BIOS (SPI ROM) on this system board must be the original equipment from the factory and cannot be used to replace one which has been utilized on other system boards.
3. If you do not follow the methods above, the Intel® Management Engine will not be updated and will cease to be effective.



Note:

- a. You can take advantage of flash tools to update the default configuration of the BIOS (SPI ROM) to the latest version anytime.
- b. When the BIOS IC needs to be replaced, you have to populate it properly onto the system board after the EEPROM programmer has been burned and follow the technical person's instructions to confirm that the MAC address should be burned or not.

Chapter 4 - RAID

The system board allows configuring RAID on Serial ATA drives. It supports RAID 0, RAID 1, RAID 5 and RAID 10.

► RAID Levels

RAID 0 (Striped Disk Array without Fault Tolerance)

RAID 0 uses two new identical hard disk drives to read and write data in parallel, interleaved stacks. Data is divided into stripes and each stripe is written alternately between two disk drives. This improves the I/O performance of the drives at different channel; however it is not fault tolerant. A failed disk will result in data loss in the disk array.

RAID 1 (Mirroring Disk Array with Fault Tolerance)

RAID 1 copies and maintains an identical image of the data from one drive to the other drive. If a drive fails to function, the disk array management software directs all applications to the other drive since it contains a complete copy of the drive's data. This enhances data protection and increases fault tolerance to the entire system. Use two new drives or an existing drive and a new drive but the size of the new drive must be the same or larger than the existing drive.

RAID 5

RAID 5 stripes data and parity information across hard drives. It is fault tolerant and provides better hard drive performance and more storage capacity.

RAID 10 (Mirroring and Striping)

RAID 10 is a combination of data striping and data mirroring providing the benefits of both RAID 0 and RAID 1. Use four new drives or an existing drive and three new drives for this configuration.

RAID Level	Min. Drives	Protection	Description
RAID 0	2	None	Data striping without redundancy
RAID 1	2	Single Drive Failure	Disk mirroring
RAID 5	3	Single Drive Failure	Block-level data striping with distributed parity
RAID 10	4	1 Disk Per Mirrored Stripe (not same mirror)	Combination of RAID 0 (data striping) and RAID 1 (mirroring)

► Setup Procedure

To enable the RAID function, the following settings are required.

1. Install SATA drives.
2. Enable RAID in the Insyde BIOS.
3. Create a RAID volume.
- 3-1. Create a RAID volume if the boot type is UEFI.
4. Install the Intel Rapid Storage Technology Utility.

Step 1: Install SATA Drives

Refer to chapter 2 for details on connecting the Serial ATA drives.



Important:

1. Please make sure the SATA drives that you are to create a RAID volume with are connected and powered, and are able to be detected by the system. Otherwise, the RAID BIOS utility would not be accessible.
2. While creating a RAID volume, please make sure the system, drives, and cables are perfectly steady and mounted correctly. Disturbance during creating a RAID volume will result in irreversible data corruption stored on the drive.

Step 2: Enable RAID in the Insyde BIOS

1. Power-on the system then press to enter the main menu of the Insyde BIOS.
2. Go to "Advanced" menu and select the "SATA Configuration" menu.
3. Change the "Configure SATA as" to "RAID".
4. Save the changes in the "Exit" menu and reboot the system, or press "F10" and "yes".

► Setup Procedure

Step 3: Create a RAID Volume

1. When the Intel® RST option ROM status screen displays during POST, press <Ctrl> and <I> simultaneously to enter the option ROM user interface.
2. Select 1: Create RAID Volume and press <Enter>.
3. Create a volume name and press <Enter>.
4. Use the up or down arrow keys to select the RAID level and press <Enter>.
5. Use the up or down arrow keys to select the strip size and press <Enter>.
6. Select the capacity and press <Enter>. You must select less than one hundred percent of the available volume space to leave space for the second volume.
7. Press <Enter> to create the volume.
8. At the prompt, press <Y> to confirm volume creation.
9. Select 4: Exit and press <Enter>.
10. Press <Y> to confirm exit.

► Setup Procedure

Step 3-1: Create a RAID Volume in UEFI Mode

If the boot type is set to UEFI, RAID volume creation will be different. Please use the following steps to create RAID volumes. To set the boot type, enter the Insyde BIOS and go to "Boot" > "Boot Type".

1. Go to the "Advanced" menu in the Insyde BIOS and select "UEFI Device Manager".

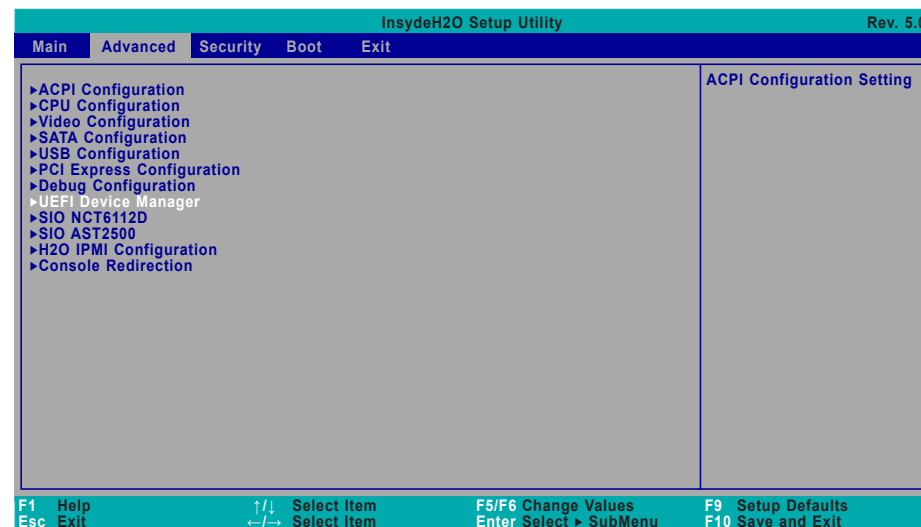

2. The screen displays all available drives. Select "Create RAID volume" to create a RAID volume.
3. Use the up or down arrow keys to select the RAID level and press <Enter>.
4. Use the up or down arrow keys to scroll through the list of hard drives and press <Enter> to select the drive.
5. Press <Enter>.
6. Use the up or down arrow keys to select the strip size and press <Enter>.
7. Enter the volume size and press <Enter>.
8. At the prompt, press <Y> to confirm volume creation.

► Setup Procedure

Step 4: Install Intel Rapid Storage Technology

The Intel Rapid Storage Technology can be installed from within Windows. It allows you to display, manage (create, delete, migrate), and monitor SATA and RAID volume via user-friendly and icon-driven UI, and enables enhanced performance and power management for your storage subsystems.