



ADS101_ADS103

Thin Mini-ITX Industrial Motherboard
User's Manual

Copyright

This publication contains information that is protected by copyright. No part of it may be reproduced in any form or by any means or used to make any transformation/adaptation without the prior written permission from the copyright holders.

This publication is provided for informational purposes only. The manufacturer makes no representations or warranties with respect to the contents or use of this manual and specifically disclaims any express or implied warranties of merchantability or fitness for any particular purpose. The user will assume the entire risk of the use or the results of the use of this document. Further, the manufacturer reserves the right to revise this publication and make changes to its contents at any time, without obligation to notify any person or entity of such revisions or changes.

Changes after the publication's first release will be based on the product's revision. The website will always provide the most updated information.

© 2024. All Rights Reserved.

Trademarks

Product names or trademarks appearing in this manual are for identification purpose only and are the properties of the respective owners.

FCC and DOC Statement on Class B

This equipment has been tested and found to comply with the limits for a Class B digital device, pursuant to Part 15 of the FCC rules. These limits are designed to provide reasonable protection against harmful interference when the equipment is operated in a residential installation. This equipment generates, uses and can radiate radio frequency energy and, if not installed and used in accordance with the instruction manual, may cause harmful interference to radio communications. However, there is no guarantee that interference will not occur in a particular installation. If this equipment does cause harmful interference to radio or television reception, which can be determined by turning the equipment off and on, the user is encouraged to try to correct the interference by one or more of the following measures:

- Reorient or relocate the receiving antenna.
- Increase the separation between the equipment and the receiver.
- Connect the equipment into an outlet on a circuit different from that to which the receiver is connected.
- Consult the dealer or an experienced radio TV technician for help.

Notice:

1. The changes or modifications not expressly approved by the party responsible for compliance could void the user's authority to operate the equipment.
2. Shielded interface cables must be used in order to comply with the emission limits.

Table of Contents

- Chapter 1 - Introduction..... 6
 - Specifications 6
 - Block Diagram 9
 - Dimension 9
- Chapter 2 - Hardware Installation..... 10
 - Board Layout..... 10
 - Jumper Settings 12
 - Clear CMOS Data (JP5) 12
 - LVDS LCD Panel Power Supply (DPJP601) 12
 - Power Level of LVDS LCD Inverter Connector (DPJP602) 13
 - LCD Panel Power Supply (DPJP603) 13
 - USB Wake Up Select (DPJP604) 14
 - Pin Assignment 15
 - Front Audio (AUJ2)..... 15
 - USB 2.0 5-6 (UBJ7)/8-9 Headers (UBJ8)..... 15
 - CPU Fan (J10)..... 16
 - Front Panel (J11)..... 16
 - Digital I/O Power (J35) 17
 - Digital I/O (J13) 17
 - SATA Power (CN1) 18
 - LCD/Inverter Power (DPJ601) 18
 - LVDS LCD Panel (DPCN601)..... 19
 - eDP (CN23) 20
 - COM1 & COM2 (J15 & J16)..... 21
 - SOJ1 (SOJ1) 21
 - Expansion Slots..... 22
 - Installing the M.2 Module 22
 - Installing the SO-DIMM Module 24
- Chapter 3 - BIOS Settings..... 25
 - Overview 25
 - Main..... 26
 - Advanced 26
 - CPU Configuration..... 27
 - Power & Performance 27
 - Power & Performance ▶ CPU- Power Management Control 28
 - Power & Performance ▶ GT- Power Management Control 28
 - PCH-FW Configuration 29
 - Trusted Computing..... 29
 - PTN3460 Configuration 30
 - NCT6126D Super IO Configuration 30
 - NCT6126D HW Monitor 31
 - NCT6126D HW Monitor ▶ Smart FAN Function 31
 - Serial Port Console Redirection 32
 - Serial Port Console Redirection ▶ Console Redirection Settings..... 32
 - ACPI Settings..... 33
 - Network Stack Configuration..... 34
 - NVMe Configuration..... 35
 - DFI WDT Configuration..... 35
 - USB Power Control 36
 - Tls Auth Configuration 36
 - Chipset 37
 - PEG Bifurcation..... 37
 - System Agent (SA) Configuration 38
 - System Agent (SA) Configuration ▶ Graphics Configuration 38

- PCH-IO Configuration 39
 - PCH-IO Configuration ▶ PCI Express Configuration 39
 - PCH-IO Configuration ▶ SATA Configuration 40
 - PCH-IO Configuration ▶ HD Audio Configuration 40
- Security 41
 - Secure Boot..... 41
- Boot 42
 - Save & Exit 42
- Chapter 4 - RAID Settings..... 43
 - RAID Levels 43
 - Setup Procedure 43

About this Manual

This manual can be downloaded from the website.

The manual is subject to change and update without notice, and may be based on editions that do not resemble your actual products. Please visit our website or contact our sales representatives for the latest editions.

Warranty

1. Warranty does not cover damages or failures that occur from misuse of the product, inability to use the product, unauthorized replacement or alteration of components and product specifications.
2. The warranty is void if the product has been subjected to physical abuse, improper installation, modification, accidents or unauthorized repair of the product.
3. Unless otherwise instructed in this user's manual, the user may not, under any circumstances, attempt to perform service, adjustments or repairs on the product, whether in or out of warranty. It must be returned to the purchase point, factory or authorized service agency for all such work.
4. We will not be liable for any indirect, special, incidental or consequential damages to the product that has been modified or altered.

Static Electricity Precautions

It is quite easy to inadvertently damage your PC, system board, components or devices even before installing them in your system unit. Static electrical discharge can damage computer components without causing any signs of physical damage. You must take extra care in handling them to ensure against electrostatic build-up.

1. To prevent electrostatic build-up, leave the system board in its anti-static bag until you are ready to install it.
2. Wear an antistatic wrist strap.
3. Do all preparation work on a static-free surface.
4. Hold the device only by its edges. Be careful not to touch any of the components, contacts or connections.
5. Avoid touching the pins or contacts on all modules and connectors. Hold modules or connectors by their ends.



Important:

Electrostatic discharge (ESD) can damage your processor, disk drive and other components. Perform the upgrade instruction procedures described at an ESD workstation only. If such a station is not available, you can provide some ESD protection by wearing an antistatic wrist strap and attaching it to a metal part of the system chassis. If a wrist strap is unavailable, establish and maintain contact with the system chassis throughout any procedures requiring ESD protection.

Safety Measures

- To avoid damage to the system, use the correct AC input voltage range.
- To reduce the risk of electric shock, unplug the power cord before removing the system chassis cover for installation or servicing. After installation or servicing, cover the system chassis before plugging the power cord.

About the Package

The package contains the following items. If any of these items are missing or damaged, please contact your dealer or sales representative for assistance.

- 1 ANS101/ADS103 Motherboard
- 1 Serial ATA data & power cable w/lock (Length: 300mm)
- 1 COM port cable (Length: 250mm, 1 x COM port)
- 1 I/O shield (w/ icon (3LAN/4USB) & w/ icon (2LAN/6USB))

The board and accessories in the package may not come similar to the information listed above. This may differ in accordance with the sales region or models in which it was sold. For more information about the standard package in your region, please contact your dealer or sales representative.

Before Using the System Board

When installing the system board in a new system, you will need at least the following internal components.

- Memory module
- Storage device such as a hard disk drive.
- Power supply

External system peripherals may also be required for navigation and display, including at least a keyboard, a mouse and a video display monitor.

Chapter 1 - Introduction

► Specifications

SYSTEM	Processor	
		14th Generation Intel® LGA 1700 Socket Processors, TDP support up to 65W Intel® Core™ i9-14900 (24 Cores, 36M Cache, up to 5.8 GHz); 65W Intel® Core™ i9-14900T (24 Cores, 36M Cache, up to 5.5 GHz); 35W Intel® Core™ i7-14700 (20 Cores, 33M Cache, up to 5.4 GHz); 65W Intel® Core™ i7-14700T (20 Cores, 33M Cache, up to 5.2 GHz); 35W Intel® Core™ i5-14500 (14 Cores, 24M Cache, up to 5.0 GHz); 65W Intel® Core™ i5-14500T (14 Cores, 24M Cache, up to 4.8 GHz); 35W Intel® Core™ i5-14400 (10 Cores, 20M Cache, up to 4.7 GHz); 65W Intel® Core™ i5-14400T (10 Cores, 20M Cache, up to 4.5 GHz); 35W Intel® Core™ i3-14100 (4 Cores, 12M Cache, up to 4.7 GHz); 60W Intel® Core™ i3-14100T (4 Cores, 12M Cache, up to 4.4 GHz); 35W Intel® 300 (2 Cores, 6M Cache, 3.9 GHz); 46W
		13th Generation Intel® LGA 1700 Socket Processors, TDP support up to 65W Intel® Core™ i9-13900E (24 Cores, 36M Cache, up to 5.2 GHz); 65W Intel® Core™ i9-13900TE (24 Cores, 36M Cache, up to 5.0 GHz); 35W Intel® Core™ i7-13700E (16 Cores, 30M Cache, up to 5.1 GHz); 65W Intel® Core™ i7-13700TE (16 Cores, 30M Cache, up to 4.8 GHz); 35W Intel® Core™ i7-13700T (16 Cores, 30M Cache, up to 4.9 GHz); 35W Intel® Core™ i5-13500E (14 Cores, 24M Cache, up to 4.6 GHz); 65W Intel® Core™ i5-13500TE (14 Cores, 24M Cache, up to 4.5 GHz); 35W Intel® Core™ i5-13500T (14 Cores, 24M Cache, up to 4.6 GHz); 35W Intel® Core™ i5-13400E (10 Cores, 20M Cache, up to 4.6 GHz); 65W Intel® Core™ i3-13100E (4 Cores, 12M Cache, up to 4.4 GHz); 65W Intel® Core™ i3-13100TE (4 Cores, 12M Cache, up to 4.1 GHz); 35W Intel® Core™ i3-13100T (4 Cores, 12M Cache, up to 4.2 GHz); 35W
		12th Generation Intel® LGA 1700 Socket Processors, TDP support up to 65W Intel® Core™ i9-12900E (16 Cores, 30M Cache, up to 5.0 GHz); 65W Intel® Core™ i9-12900TE (16 Cores, 30M Cache, up to 4.8 GHz); 35W Intel® Core™ i7-12700E (12 Cores, 25M Cache, up to 4.8 GHz); 65W Intel® Core™ i7-12700TE (12 Cores, 25M Cache, up to 4.6 GHz); 35W Intel® Core™ i5-12500E (6 Cores, 18M Cache, up to 4.5 GHz); 65W Intel® Core™ i5-12500TE (6 Cores, 18M Cache, up to 4.3 GHz); 35W Intel® Core™ i3-12100E (4 Cores, 12M Cache, up to 4.2 GHz); 60W Intel® Core™ i3-12100TE (4 Cores, 12M Cache, up to 4.0 GHz); 35W Intel® Pentium® G7400E (2 Cores, 6M Cache, 3.6 GHz); 46W Intel® Pentium® G7400TE (2 Cores, 6M Cache, 3.0 GHz); 35W Intel® Celeron® G6900E (2 Cores, 4M Cache, 3.0 GHz); 46W Intel® Celeron® G6900TE (2 Cores, 4M Cache, 2.4 GHz); 35W
	Chipset	Intel® R680E/Q670E/H610E Chipset

	Memory	Two 260-pin SODIMM up to 64GB Dual Channel DDR4 3200 MHz (ECC support: R680E only)		
	BIOS	AMI SPI 256Mbit		
GRAPHICS	Controller	Intel® UHD Graphics 700 series		
	Feature	OpenGL 4.5, DirectX 12, OpenCL 2.1 HW Decode: AVC/H.264, MPEG2, VC1/WMV9, JPEG/MJPEG, HEVC/H265, VP8, VP9 HW Encode: MPEG2, AVC/H264, JPEG, HEVC/H265, VP8, VP9		
	Display	1 x DP++ 1 x DP++/HDMI 1 x LVDS/eDP 1 x DFI display extension port (DP/HDMI/VGA available) DP++: resolution up to 4096x2304 @60Hz LVDS: resolution up to 1920x1200 @ 60Hz eDP: resolution up to 4096x2160 @ 60Hz		
	Quad Displays	DP++ + DP++/HDMI + LVDS/eDP + DFI display extension port (DP/HDMI/VGA available)		
EXPANSION	Interface	1 x PCIe x16 (Gen 5) (Max. 75W)		
		1 x M.2 2230 E Key (USB/PCIe x1)		
		R680E/Q670E: 1 x M.2 2280 M Key (PCIe Gen4 x4/SATA)		
		H610E: 1 x M.2 2280 M Key (PCIe Gen3 x1/SATA)		
		R680E/Q670E: 1 x M.2 2242/3042/3052 B Key (PCIe Gen3 x1/SATA/USB 3.2 Gen2/USB 2.0) H610E: 1 x M.2 2242/3042/3052 B Key (SATA/USB 3.2 Gen1/USB 2.0)		
AUDIO	Audio Codec	Realtek ALC888		
ETHERNET	Controller	R680E:	Q670E:	H610E:
		LAN1: 1 x Intel® I226V PCIe (10/100/1000/2.5G speeds)	LAN1: 1 x Intel® I226V PCIe (10/100/1000/2.5G speeds)	LAN1: 1 x Intel® I226V PCIe (10/100/1000/2.5G speeds)
		LAN2: 1 x Intel® I210AT PCIe (10/100/1000 speeds)(Opt.)	LAN2: 1 x Intel® I210AT PCIe (10/100/1000 speeds)(Opt.)	LAN2: 1 x Intel® I210AT PCIe (10/100/1000 speeds)(Opt.)
		LAN3: 1 x Intel® I219LM PHY (10/100/1000 speeds) (support vPro/AMT)	LAN3: 1 x Intel® I219LM PHY (10/100/1000 speeds) (support vPro/AMT)	LAN3: 1 x Intel® I219V PHY (10/100/1000 speeds)
REAR I/O	Ethernet	1 x 2.5GbE (RJ-45) 1 x GbE (RJ-45) (2x by Opt.)		
	USB	R680E/Q670E: 4 x USB 3.2 Gen2 (Opt.: up to 6 x USB 3.2 Gen2) H610E: 2 x USB 3.2 Gen2 +1 x USB 3.2 Gen1+ 1 x USB 2.0		
	Display	1 x DP++ 1 x DP++/HDMI 1 x DFI display extension for (DP/HDMI/VGA) (Opt.)		

INTERNAL I/O	Serial	2 x RS-232/422/485 (without power) (2.0mm pitch)
	USB	4 x USB 2.0 (2.0mm pitch) 2 x USB 3.2 Gen1 (R680E/Q670E only)
	Display	1 x LVDS header 1 x eDP connector
	Audio	1 x Front Audio Header
	SATA	2 x SATA 3.0 (up to 6Gb/s) 1 x SATA Power R680E/Q670E: RAID 0/1/5/10 (w/ M.2 Key-M/B slot + 2 SATA Conn.)
	DIO	1 x 8-bit DIO
WATCHDOG TIMER	Output & Interval	System Reset, Programmable via Software from 1 to 255 Seconds
SECURITY	TPM	dTPM2.0
POWER	Type	Single 12V +/-10% DC (ADS101) Wide Range 15~36V (ADS103)
	Connector	DC-in Jack Right Angle Connector (4-pin) (available upon request) Straight Type Connector (4-pin) (available upon request)
	Consumption	Idle: i9-13900E 65W: 24V @ 3.14A (75.36W), 12V @ 5.52A (66.24W) Max: i9-13900E 65W: 24V @ 4.82A (115.68W), 12V @ 9.38A (112.56W)
	RTC Battery	CR2032 Coin Cell
OS SUPPORT	Microsoft	Windows 10 IoT Enterprise 64-bit
	Linux	Linux
ENVIRONMENT	Temperature	Operating: -5 to 65°C Storage: -40 to 85°C
	Humidity	Operating: 5 to 90% RH Storage: 5 to 90% RH
	MTBF	ADS101-R680DB 547,831 hrs @ 25°C; 320,230 hrs @ 45°C; 204,129 hrs @ 60°C; Calculation model: Telcordia Issue 4 Environment: GB, GC – Ground Benign, Controlled
MECHANISM	Dimensions	Mini-ITX Form Factor: 170mm (6.7") x 170mm (6.7")
	Height	PCB: 1.6mm Top Side: 33.3mm, Bottom Side: 4mm
STANDARDS AND CERTIFICATIONS	Certifications	CE, FCC Class B, RoHS, UKCA

► Block Diagram

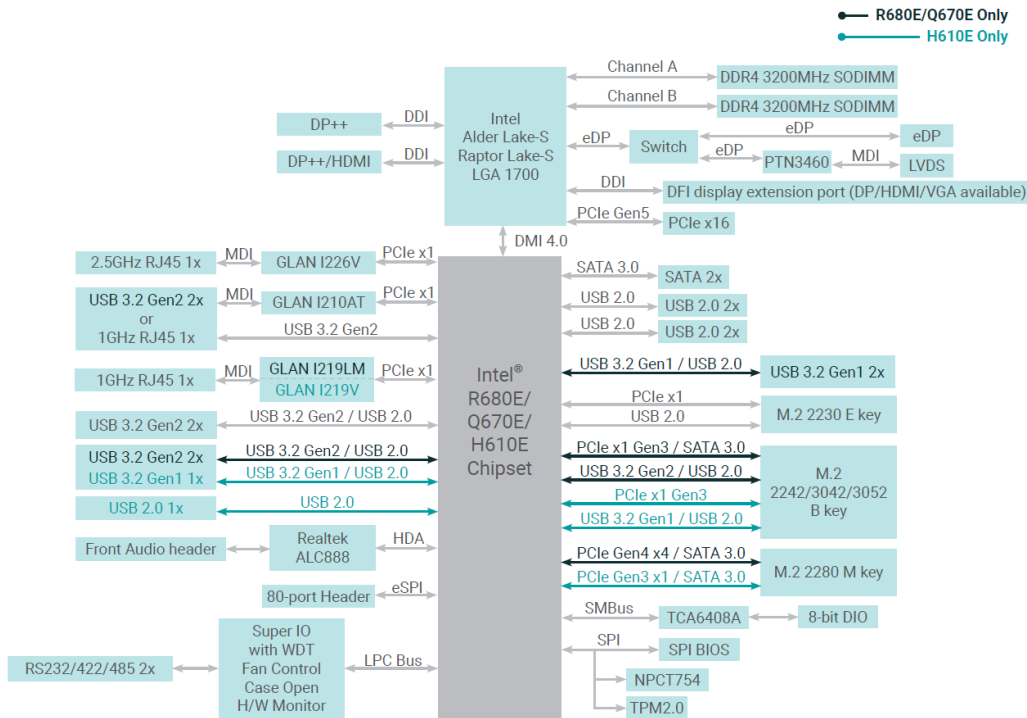

► Dimension

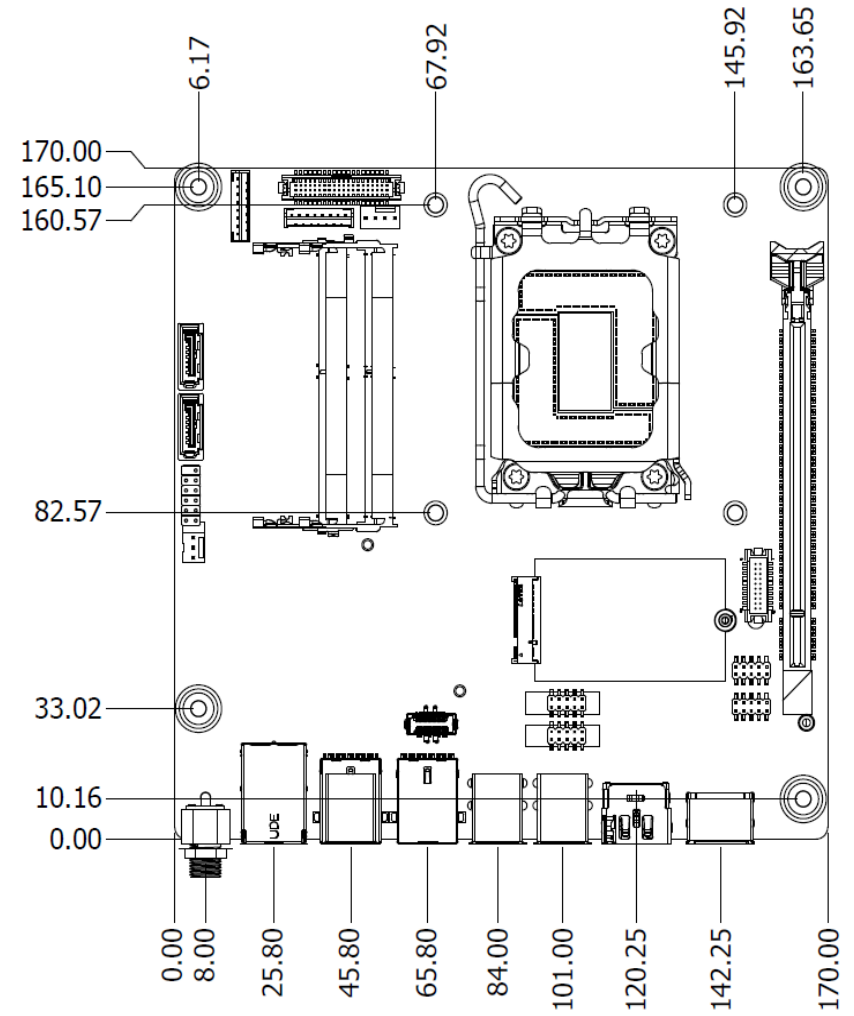

Chapter 2 - Hardware Installation

► Board Layout

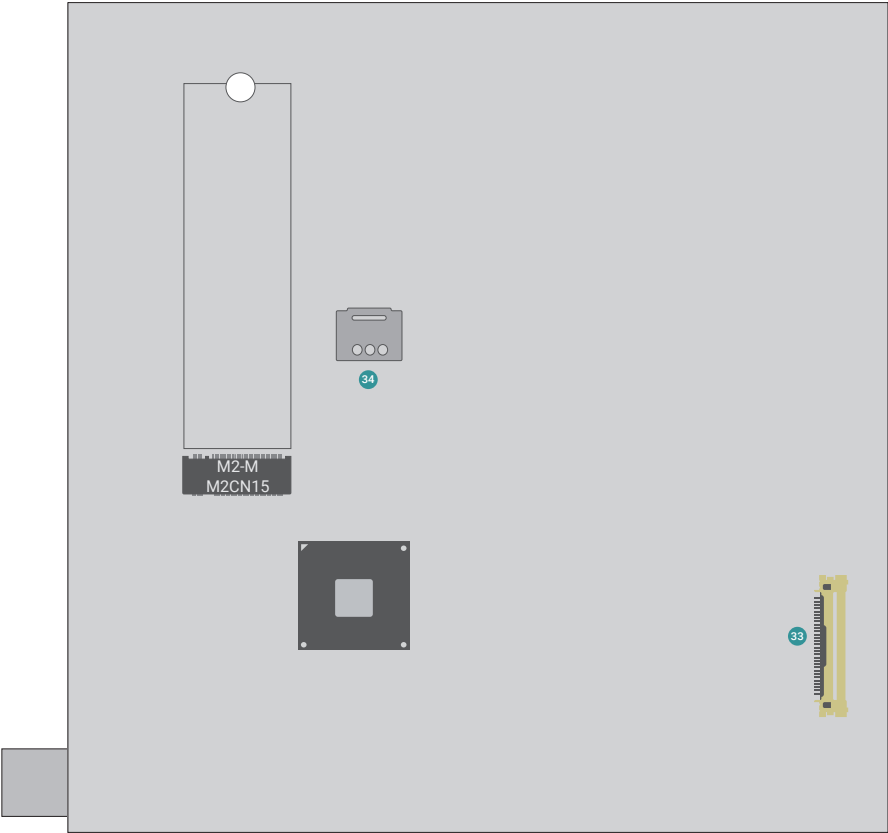
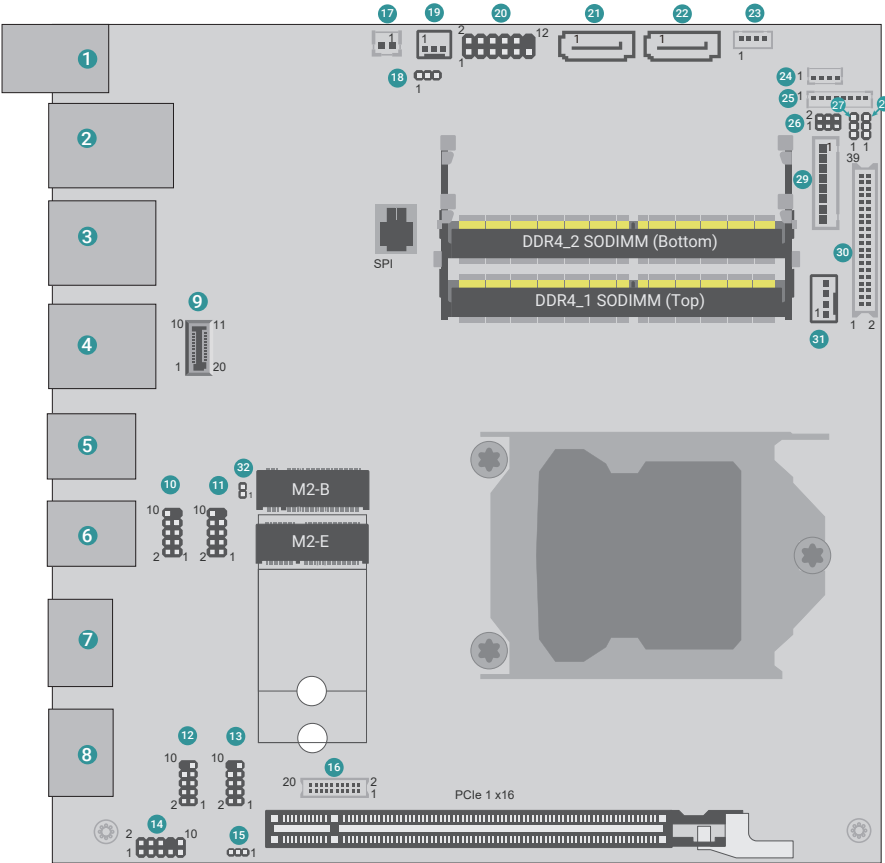

- | | |
|--------------------------|---|
| 1 DC-in | 21 SATA0 |
| 2 LAN1 | 22 SATA1 |
| 3 LAN2 / USB3.2 Gen2 | 23 SATA Power |
| 4 LAN3 | 24 DIO Power |
| 5 USB3.2 Gen2 | 25 DIO |
| 6 USB3.2 Gen2 | 26 LCD Panel Power Supply |
| 7 DP++ / HDMI | 27 Power Level of LVDS LCD Inverter Connector |
| 8 DP++ | 28 LVDS LCD Panel Power Supply |
| 9 USB3_5/6
USB2_12/13 | 29 LVDS Power |
| 10 USB2_8/9 | 30 LVDS |
| 11 USB2_5/6 | 31 CPU Fan |
| 12 COM1 | 32 SOJ1 |
| 13 COM2 | 33 eDP |
| 14 Front Audio | 34 SIM Card Slot |
| 15 USB Wake Up Select | |
| 16 DDI | |
| 17 Battery | |
| 18 Clear CMOS Data | |
| 19 System Fan | |
| 20 Front Panel | |

► Jumper Settings

Clear CMOS Data (JP5)

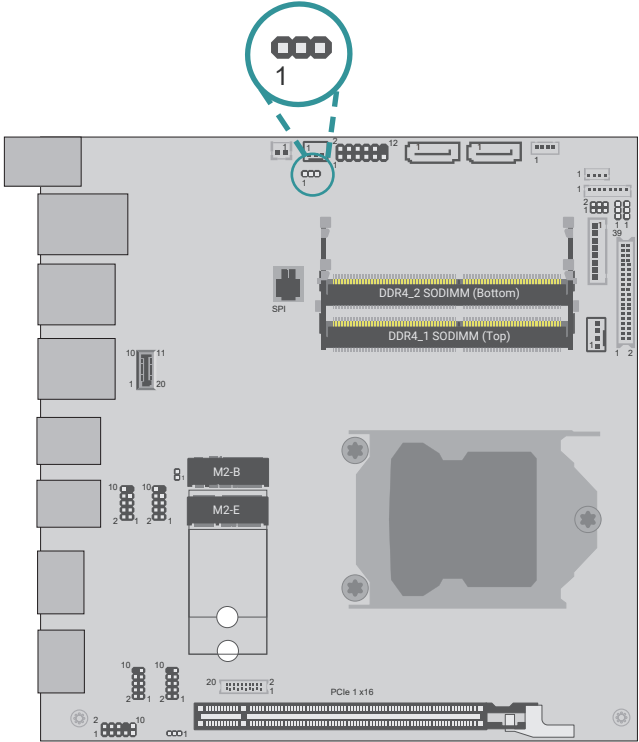

■ 1-2 On: Normal (Default)



■ 2-3 On: Clear CMOS Data

LVDS LCD Panel Power Supply (DPJP601)

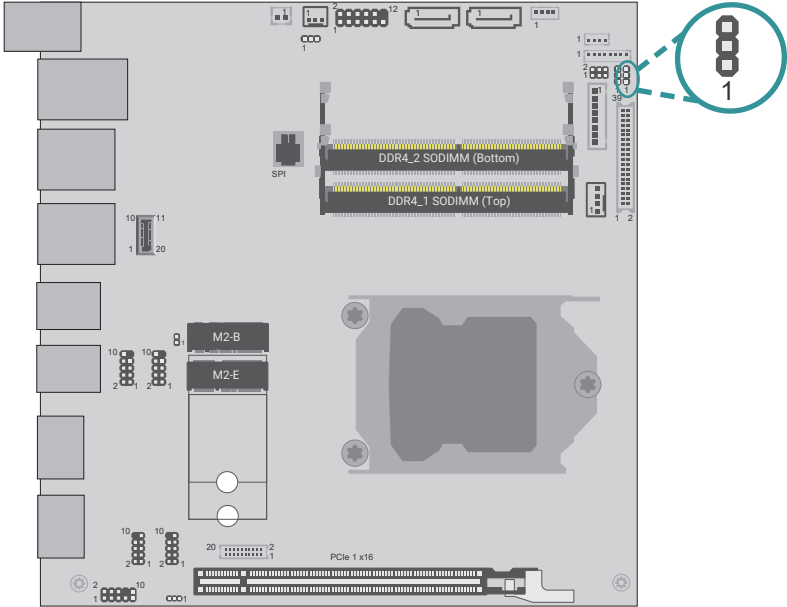

■ 1-2 On: 3V3 (Default)



■ 2-3 On: 5V

Power Level of LVDS LCD Inverter Connector (DPJP602)

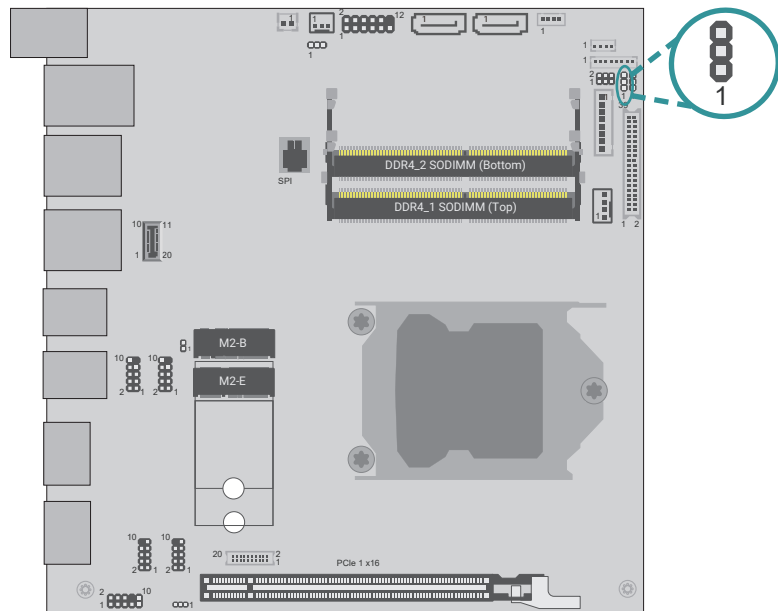

■ 1-2 On: +12V (Default)



■ 2-3 On: +5V

LCD Panel Power Supply (DPJP603)

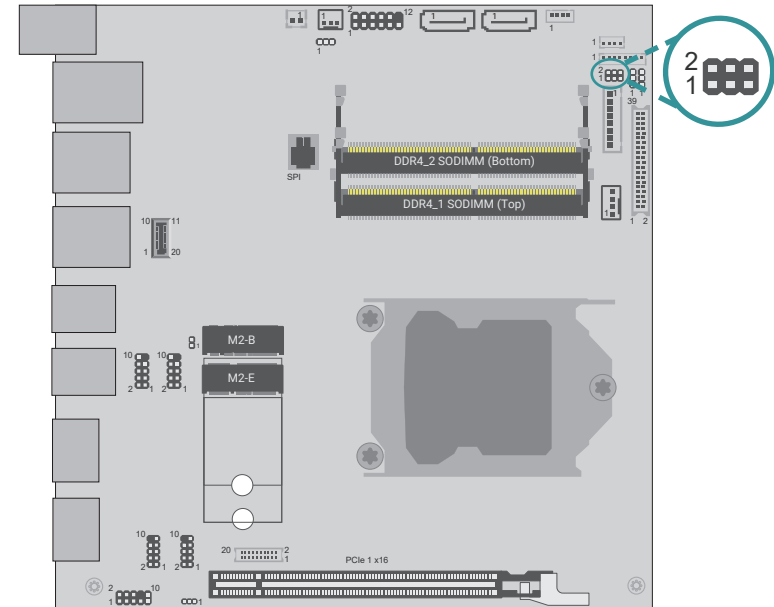

■ 1-2 On: +12V

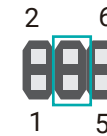

■ 3-4 On: +5V



■ 5-6 On: +3.3V (Default)

USB Wake Up Select (DPJP604)

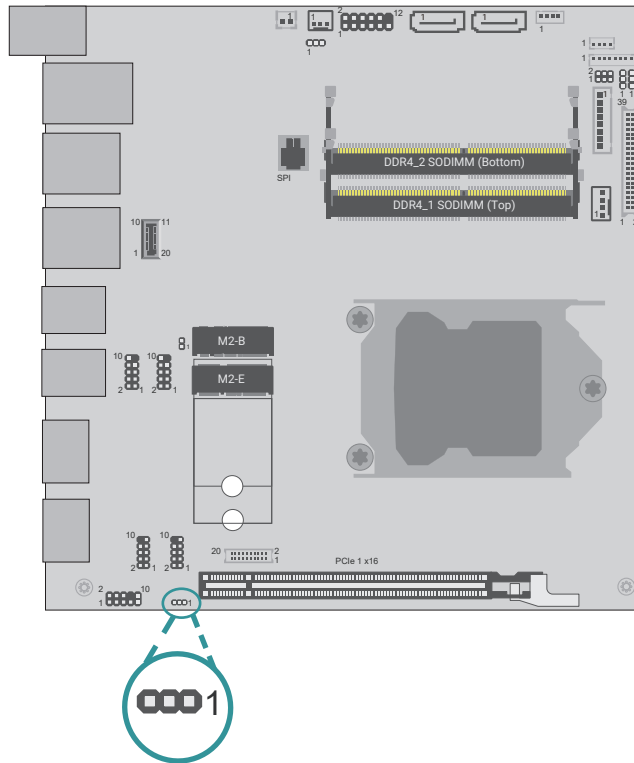

■ 1-2 On: 5VSB (Default)



■ 2-3 On: 5V

► **Pin Assignment**

Front Audio (AUJ2)

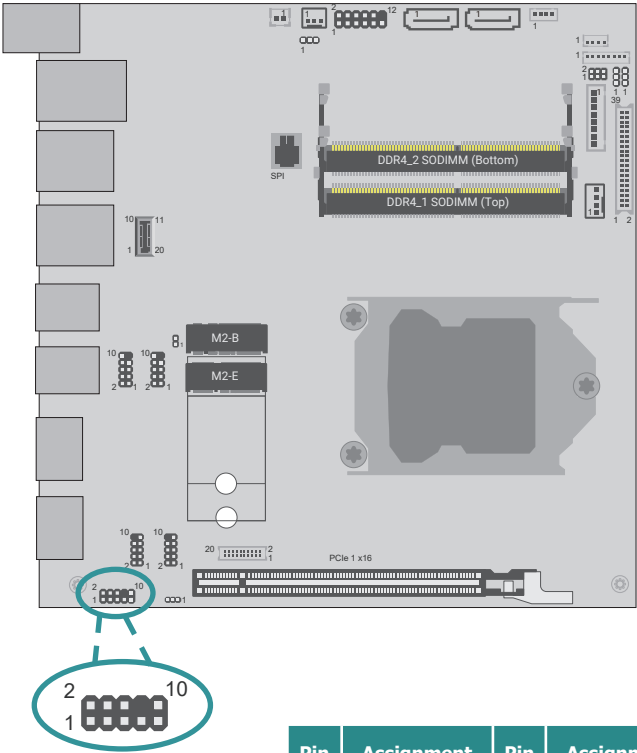

Pin	Assignment	Pin	Assignment
1	Mic-L	2	GND
3	Mic-R	4	NC
5	Line-Out-R	6	Mic-JD (sense)
7	GND	8	KEY
9	Line-Out-L	10	Line-JD (sense)

USB 2.0 5-6 (UBJ7)/8-9 Headers (UBJ8)

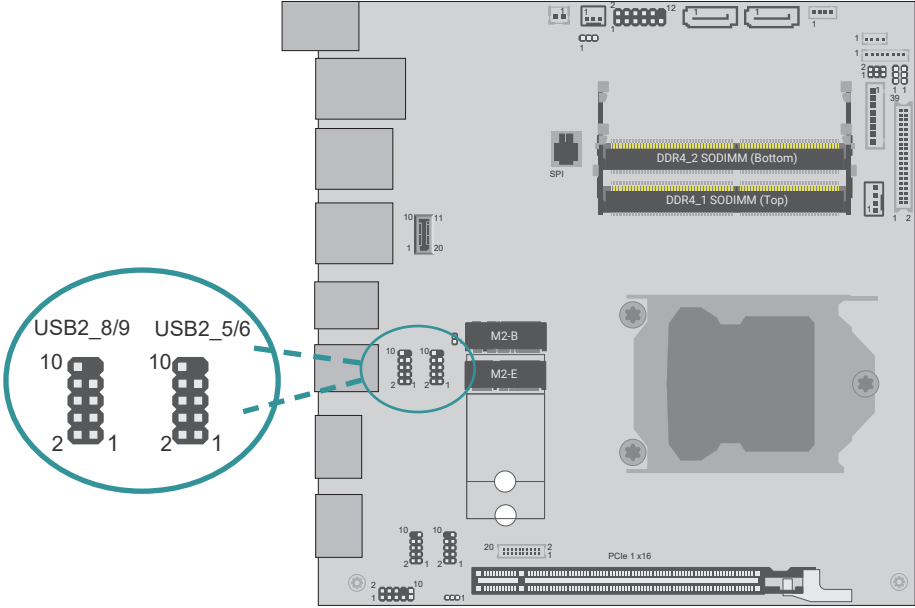

Pin	Assignment	Pin	Assignment
1	PWR	2	PWR
3	DATA-	4	DATA-
5	DATA+	6	DATA+
7	GND	8	GND
9	---	10	NC

CPU Fan (J10)

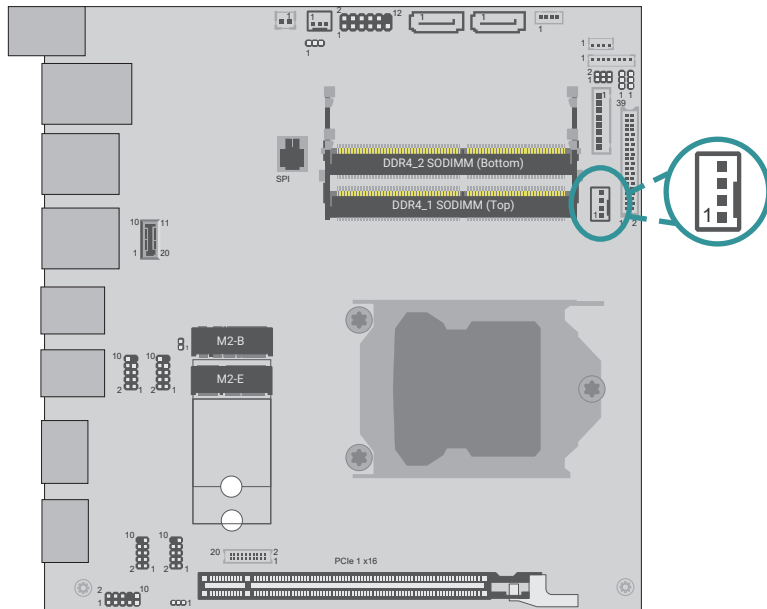

Pin	Assignment
1	GND
2	Power
3	Sense
4	Speed Control

Front Panel (J11)

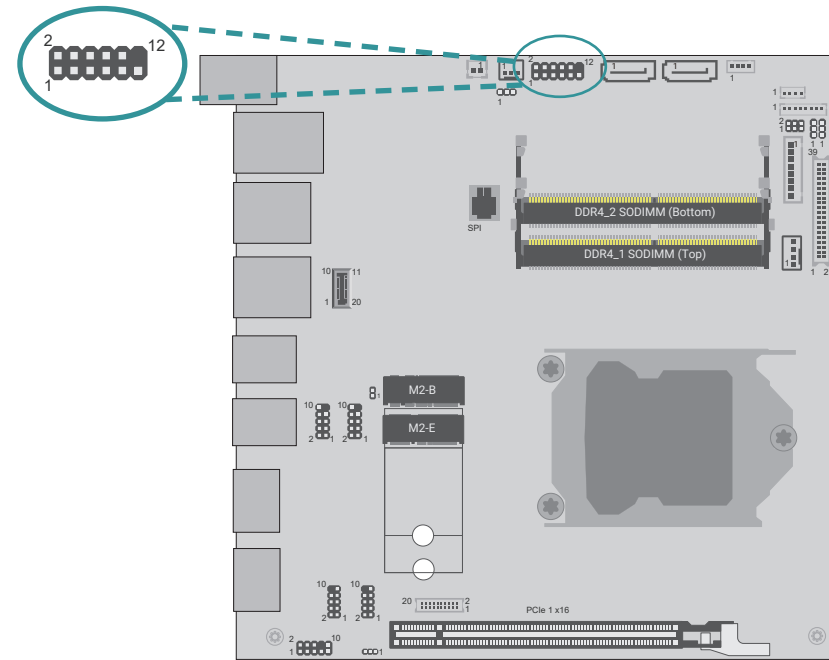

	Pin	Assignment		Pin	Assignment
	1	NC		2	LED Power
HD-LED	3	HDD Power	PWR-LED	4	LED Power
	5	Signal		6	Signal
RESET	7	GND	ATX-SW	8	GND
	9	Signal		10	Signal
	11	NC		12	---

Digital I/O Power (J12)

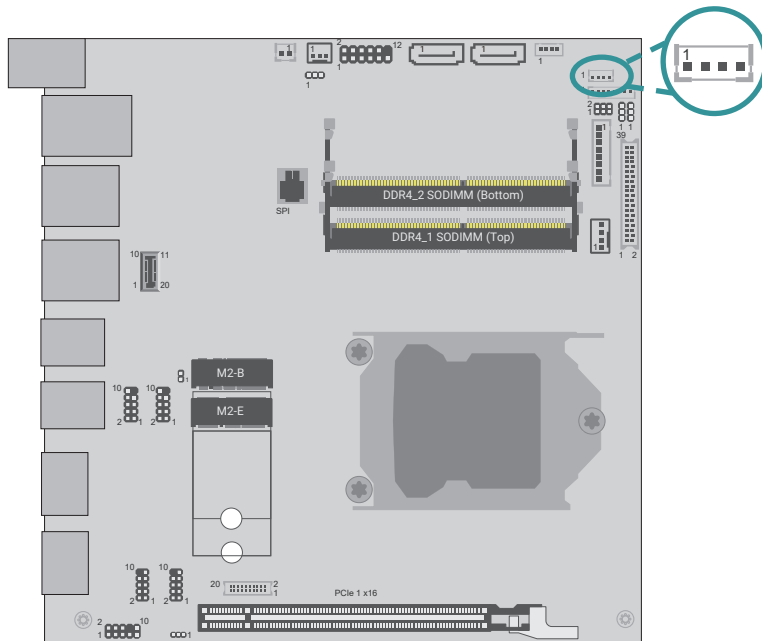

Pin	Assignment
1	+12V
2	GND
3	5VSB
4	+5V

Digital I/O (J13)

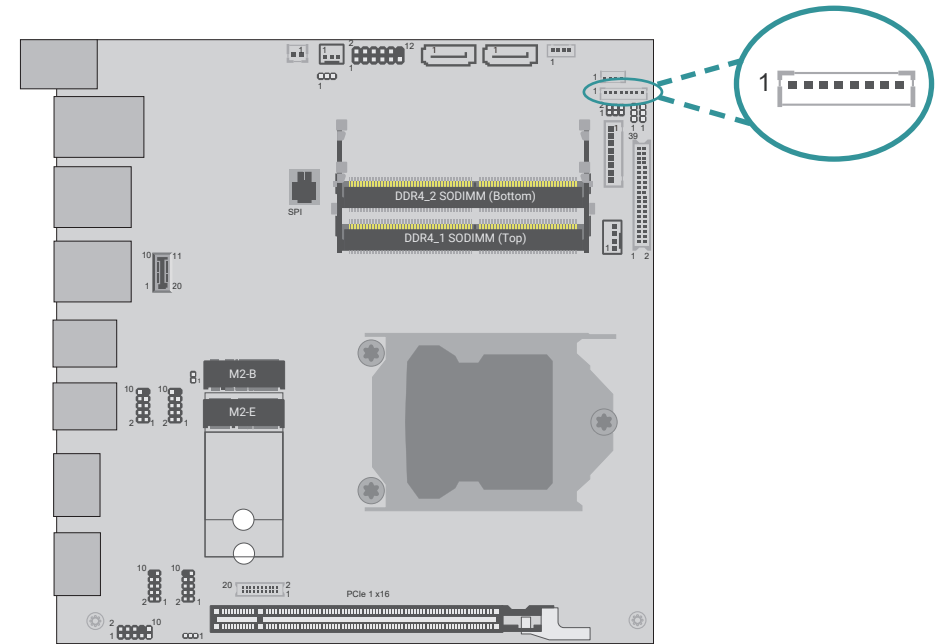

Pin	Assignment
1	DI00
2	DI01
3	DI02
4	DI03
5	DI04
6	DI05
7	DI06
8	DI07

SATA Power (CN1)

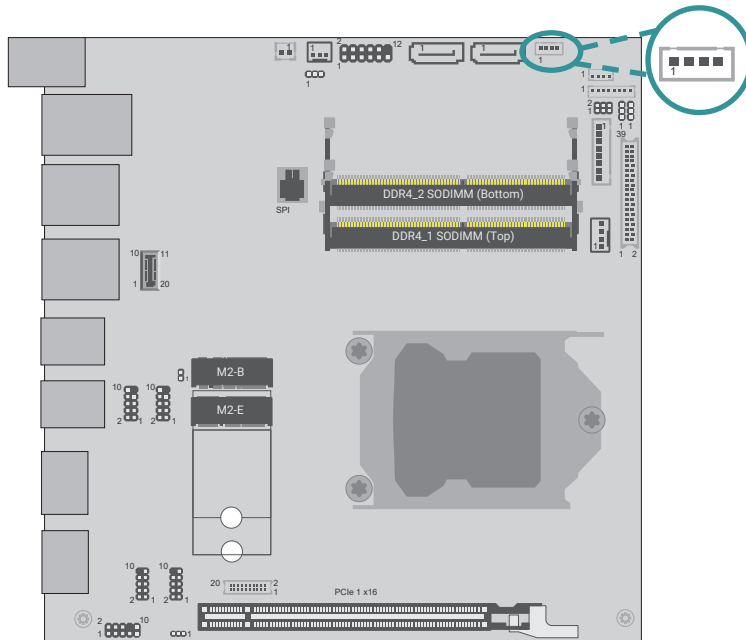

Pin	Assignment
1	+12V
2	GND
3	GND
4	5V

LCD/Inverter Power (DPJ601)

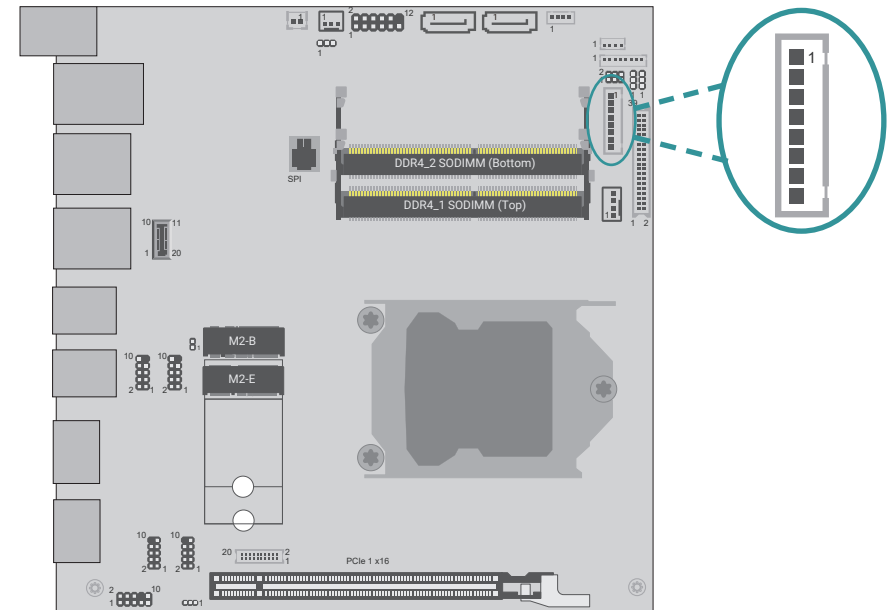

Pin	Assignment
1	GND
2	GND
3	Panel Inverter Brightness Voltage Control
4	Panel Power
5	+3.3V
6	Panel Backlight On/Off Control
7	LCD/Inverter Power
8	LCD/Inverter Power

LVDS LCD Panel (DPCN601)

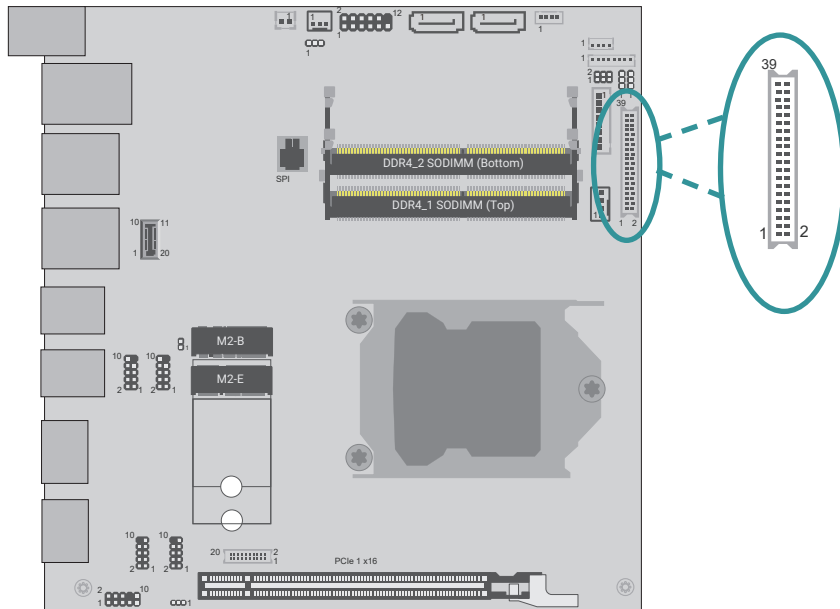

Pin	Assignment	Pin	Assignment
1	GND	2	GND
3	LVDSA_3+	4	LVDSB_3+
5	LVDSA_3-	6	LVDSB_3-
7	GND	8	GND
9	LVDSA_2+	10	LVDSB_2+
11	LVDSA_2-	12	LVDSB_2-
13	GND	14	GND
15	LVDSA_1+	16	LVDSB_1+
17	LVDSA_1-	18	LVDSB_1-
19	GND	20	GND
21	LVDSA_0+	22	LVDSB_0+
23	LVDSA_0-	24	LVDSB_0-
25	GND	26	GND
27	LVDSA_CLK+	28	LVDSB_CLK+
29	LVDSA_CLK-	30	LVDSB_CLK-
31	GND	32	GND
33	DDC_CLK	34	NC
35	DDC_DATA	36	+3.3V
37	Panel Power	38	Panel Power
39	Panel Power	40	Panel Power

eDP (CN23)

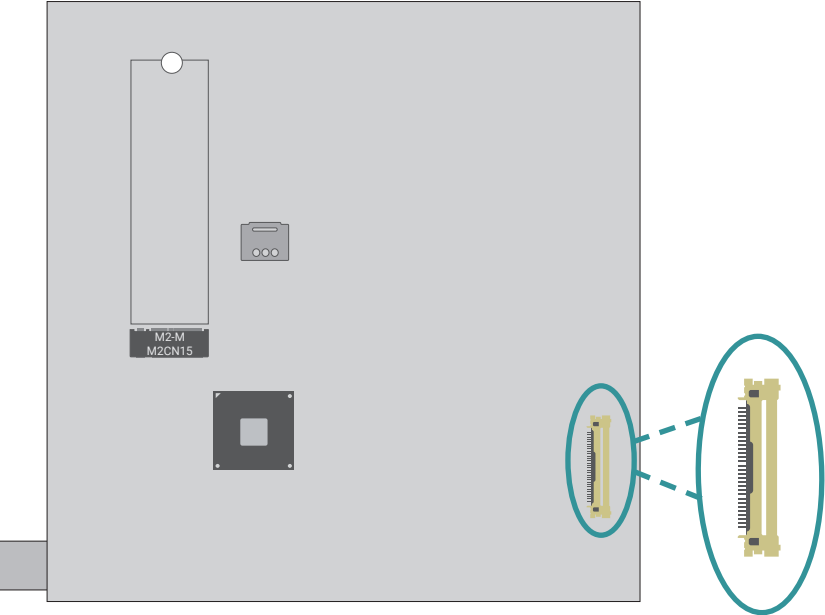

Pin	Assignment	Pin	Assignment
1	NC	21	eDP_PANEL_PWR
2	VCC_INV_PWR	22	eDP_PANEL_PWR
3	VCC_INV_PWR	23	eDP_PANEL_PWR
4	VCC_INV_PWR	24	GND
5	VCC_INV_PWR	25	eDP_AUXN_C
6	NC	26	eDP_AUXP_C
7	NC	27	GND
8	DIMMING	28	eDP_LANE0_P
9	BLONOFF	29	eDP_LANE0_N
10	GND	30	GND
11	GND	31	eDP_LANE1_P
12	GND	32	eDP_LANE1_N
13	GND	33	GND
14	eDP_HDP_C	34	eDP_LANE2_P
15	GND	35	eDP_LANE2_N
16	GND	36	GND
17	GND	37	eDP_LANE3_P
18	GND	38	eDP_LANE3_N
19	NC	39	GND
20	eDP_PANEL_PWR	40	NC

COM1 & COM2 (J15 & J16)

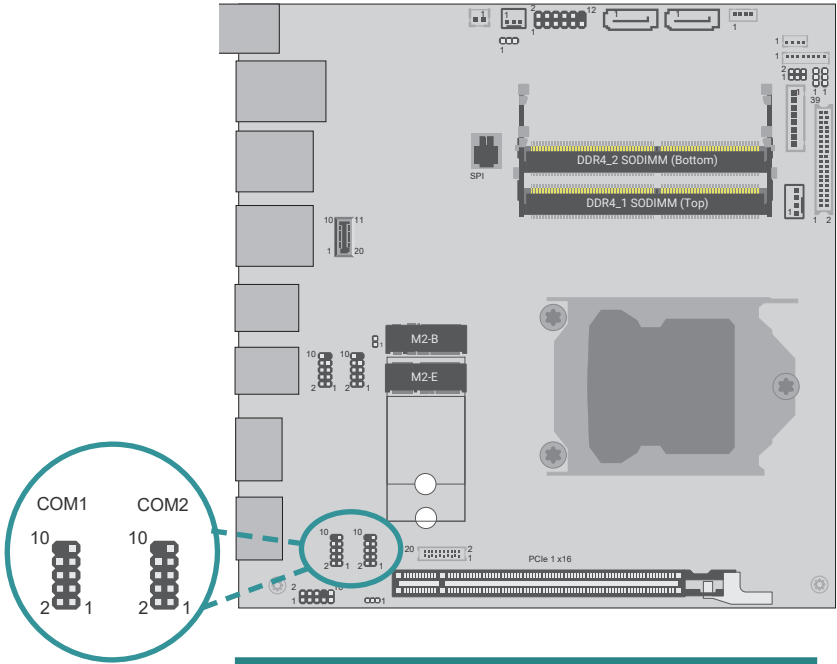

Pin	RS232	RS422 Full Duplex	RS485
1	DCD-	TXD-	DATA-
2	RD	TXD+	DATA+
3	TD	RXD+	N.C.
4	DTR-	RXD-	N.C.
5	GND	GND	GND
6	DSR-	N.C.	N.C.
7	RTS-	N.C.	N.C.
8	CTS-	N.C.	N.C.
9	RI-	N.C.	N.C.

SOJ1 (SOJ1)

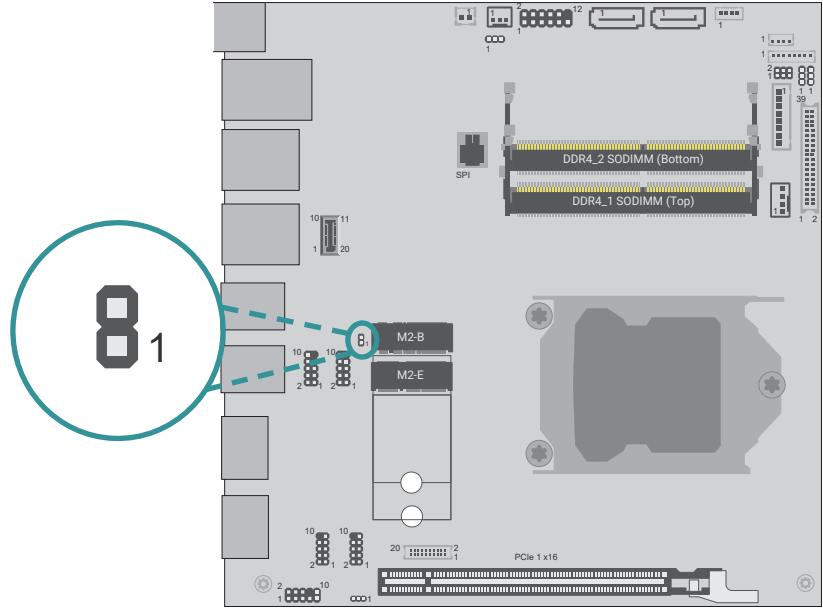

Pin	Assignment
1	Signal
2	GND

System Fan (J9)

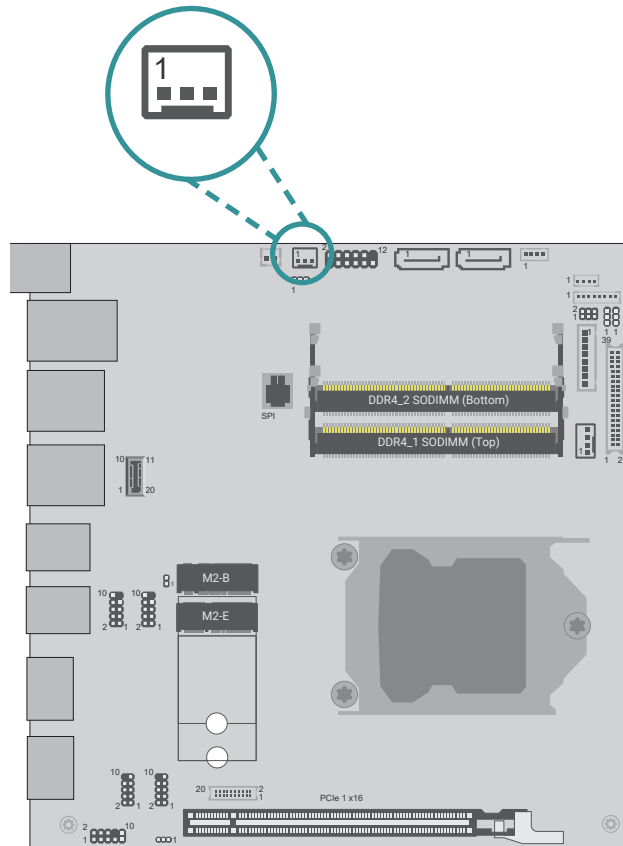

Pin	Assignment
1	GND
2	PWM
3	TACH

► **Expansion Slots**

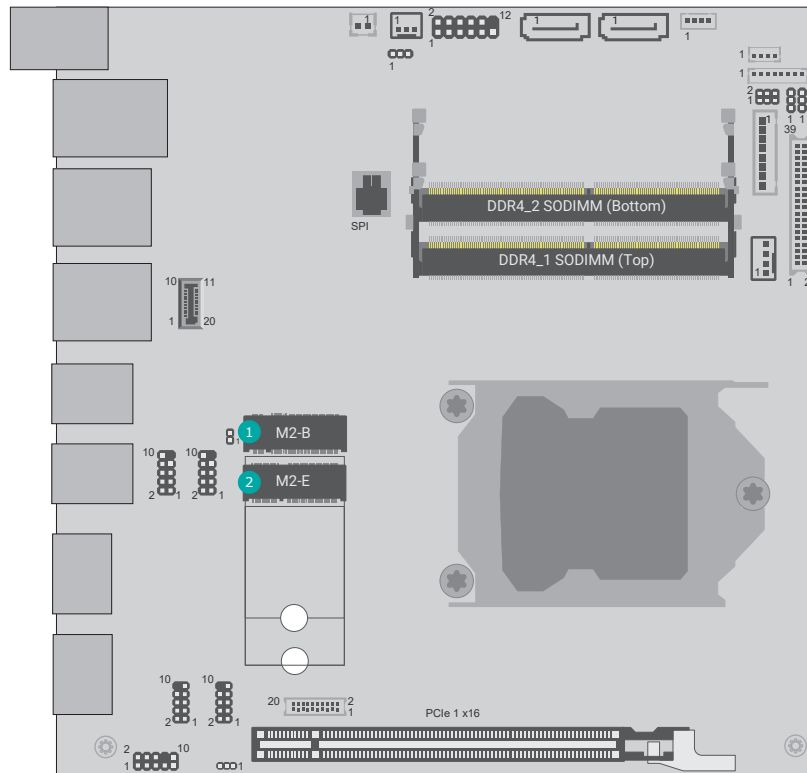

1 M.2 B-Key

2 M.2 E-Key

Installing the M.2 Module

Before installing the M.2 module into the M.2 socket, please make sure that the following safety cautions are well-attended.

1. Make sure the PC and all other peripheral devices connected to it has been powered down.
2. Disconnect all power cords and cables.
3. Locate the M.2 socket on the system board
4. Make sure the notch on card is aligned to the key on the socket.
5. Make sure the standoff screw is removed from the standoff.

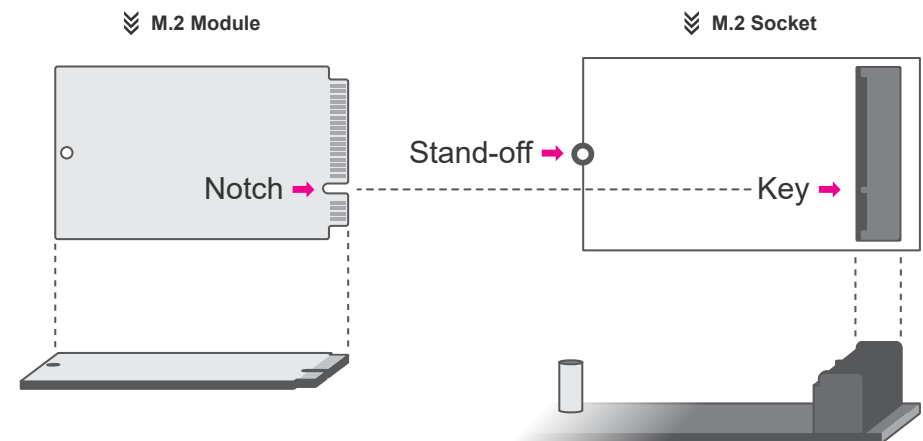

Please follow the steps below to install the card into the socket.

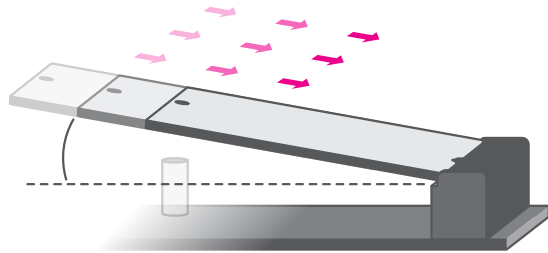

Step 1:
Insert the card into the socket at an angle while making sure the notch and key are perfectly aligned.

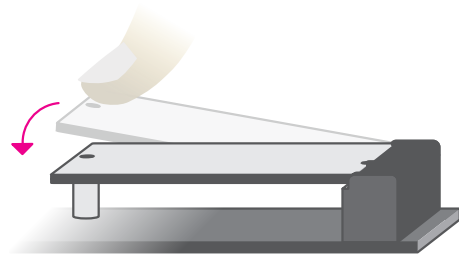

Step 2:
Press the end of the card far from the socket down until against the stand-off.

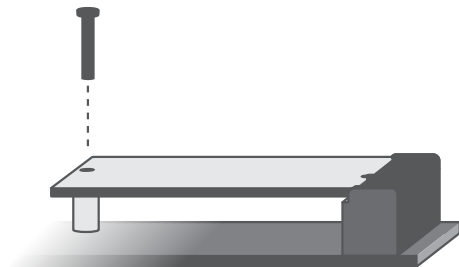

Step 3:
Screw tight the card onto the stand-off with a screw driver and a stand-off screw until the gap between the card and the stand-off closes up. The card should be lying parallel to the board when it's correctly mounted.

Installing the SO-DIMM Module

Before installing the memory module, please make sure that the following safety cautions are well-attended.

1. Make sure the PC and all other peripheral devices connected to it has been powered down.
2. Disconnect all power cords and cables.
3. Locate the SO-DIMM socket on the system board
4. Make sure the notch on memory card is aligned to the key on the socket.

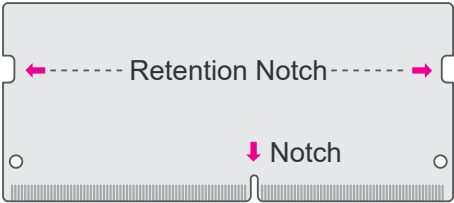

«« DDR4 SO-DIMM

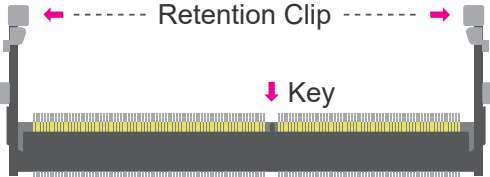

«« Socket Top View

Please follow the steps below to install the memory card into the socket.

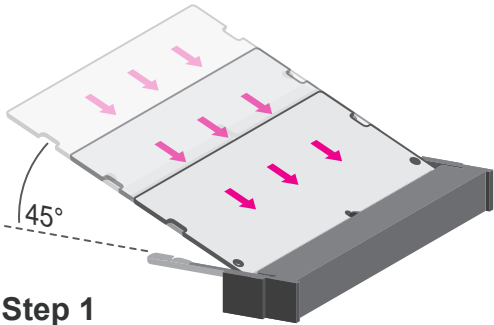

Step 1

Step 1:
 Insert the memory card into the slot while making sure 1) the notch and the key are aligned, and 2) the non-connector end rises approximately 45 degrees horizontally. Press the card firmly into the socket while applying and maintaining even pressure on both ends.

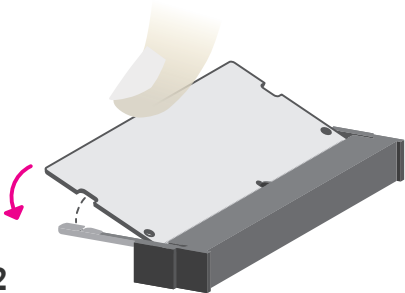

Step 2

Step 2:
 Press the end of the card far from the socket down while making sure the retention notch and the clip align as indicated by the dotted line in the illustration. If the retention notch and the clip do not align, please remove the card and re-insert it. Press the card all the way down.

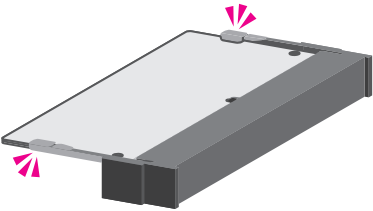

Step 3

Step 3:
 The clips snap automatically and abruptly to the retention notches of the card sounding a distinctive click, and lock the card in place. Inspect that the clip sits in the notch. If not, please pull the clips outward, release and remove the card, and mount it again.

Chapter 3 - BIOS Settings

► Overview

The BIOS is a program that takes care of the basic level of communication between the CPU and peripherals. It contains codes for various advanced features found in this system board.

The BIOS allows you to configure the system and save the configuration in a battery-backed CMOS so that the data retains even when the power is off. In general, the information stored in the CMOS RAM of the EEPROM will stay unchanged unless a configuration change has been made such as a hard drive replaced or a device added.

It is possible that the CMOS battery will fail causing CMOS data loss. If this happens, you need to install a new CMOS battery and reconfigure the BIOS settings.



Note:

The BIOS is constantly updated to improve the performance of the system board; therefore the BIOS screens in this chapter may not appear the same as the actual one. These screens are for reference purpose only.

Default Configuration

Most of the configuration settings are either predefined according to the Load Optimal Defaults settings which are stored in the BIOS or are automatically detected and configured without requiring any actions. There are a few settings that you may need to change depending on your system configuration.

Entering the BIOS Setup Utility

The BIOS Setup Utility can only be operated from the keyboard and all commands are keyboard commands. The commands are available at the right side of each setup screen.

The BIOS Setup Utility does not require an operating system to run. After you power up the system, the BIOS message appears on the screen and the memory count begins. After the memory test, the message "Press DEL to run setup" will appear on the screen. If the message disappears before you respond, restart the system or press the "Reset" button. You may also restart the system by pressing the <Ctrl> <Alt> and keys simultaneously.

Legends

Keys	Function
Right / Left arrow	Move the highlight left or right to select a menu
Up / Down arrow	Move the highlight up or down between submenus or fields
<Enter>	Enter the highlighted submenu
+ (plus key)/F6	Scroll forward through the values or options of the highlighted field
- (minus key)/F5	Scroll backward through the values or options of the highlighted field
<F1>	Display general help
<F2>	Display previous values
<F9>	Optimized defaults
<F10>	Save and Exit
<Esc>	Return to previous menu

Scroll Bar

When a scroll bar appears to the right of the setup screen, it indicates that there are more available fields not shown on the screen. Use the up and down arrow keys to scroll through all the available fields.

Submenu

When "►" appears on the left of a particular field, it indicates that a submenu which contains additional options are available for that field. To display the submenu, move the highlight to that field and press <Enter>.

► **Main**

The Main menu is the first screen that you will see when you enter the BIOS Setup Utility.

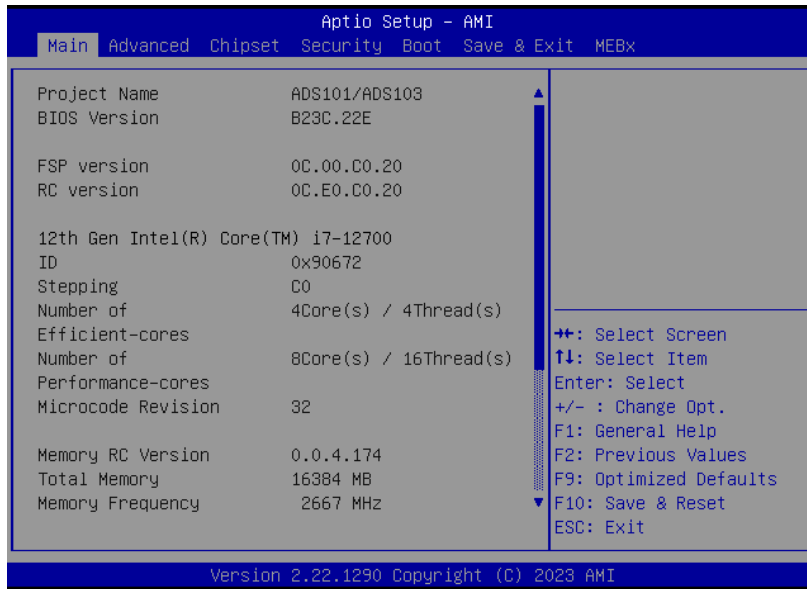

System Date

The date format is <month>, <date>, <year>. Press "Tab" to switch to the next field and press "-" or "+" to modify the value.

System Time

The time format is <hour>, <minute>, <second>. The time is based on the 24-hour military-time clock. For example, 1 p.m. is 13:00:00. Hour displays hours from 00 to 23. Minute displays minutes from 00 to 59. Second displays seconds from 00 to 59.

► **Advanced**

The Advanced menu allows you to configure your system for basic operation. Some entries are defaults required by the system board, while others, if enabled, will improve the performance of your system or let you set some features according to your preference.



Important:
 Setting incorrect field values may cause the system to malfunction.

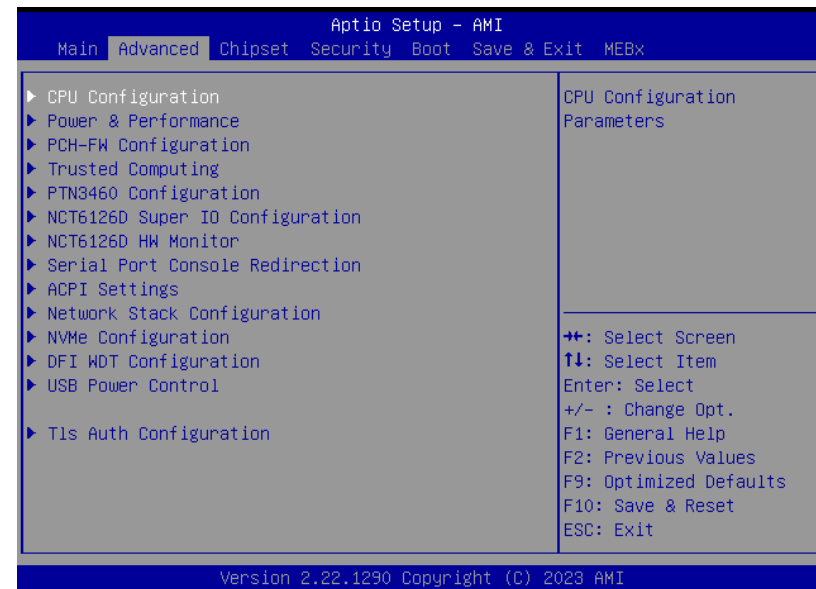

► Advanced

CPU Configuration



Intel (VMX) Virtualization Technology

When this field is set to **Enabled**, the VMM can utilize the additional hardware capabilities provided by Vanderpool Technology.

Hyper-threading

Enables this field for Windows XP and Linux which are optimized for Hyper-Threading technology. Select disabled for other OSes not optimized for Hyper-Threading technology. When disabled, only one thread per enabled core is enabled.

AES

Enable / Disable AES (Advanced Encryption Standard)

► Advanced

Power & Performance

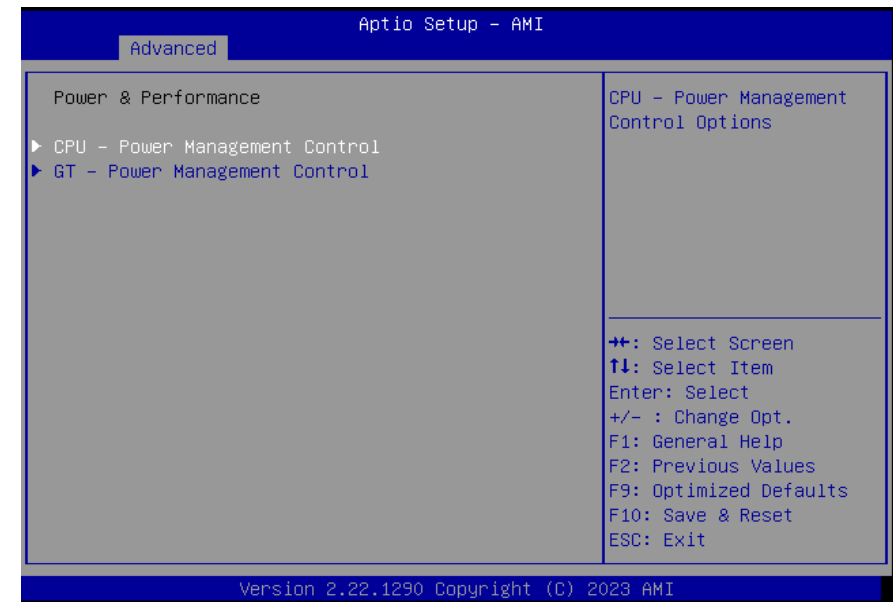

► **Advanced**

Power & Performance ► CPU- Power Management Control

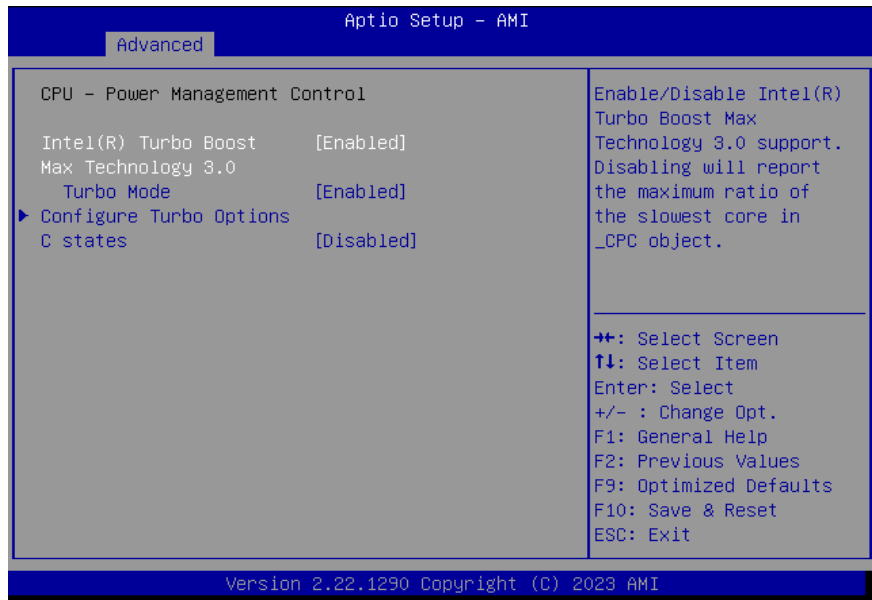

Intel (R) SpeedStep(tm)

This field is used to enable or disable the Intel SpeedStep® Technology, which helps optimize the balance between system's power consumption and performance. After it is enabled in the BIOS, EIST features can then be enabled via the operating system's power management.

Turbo Mode

Enable or disable turbo mode of the processor. This field will only be displayed when EIST is enabled.

C states

Enable or disable CPU Power Management. It allows CPU to enter "C states" when it's idle and nothing is executing.

► **Advanced**

Power & Performance ► GT- Power Management Control

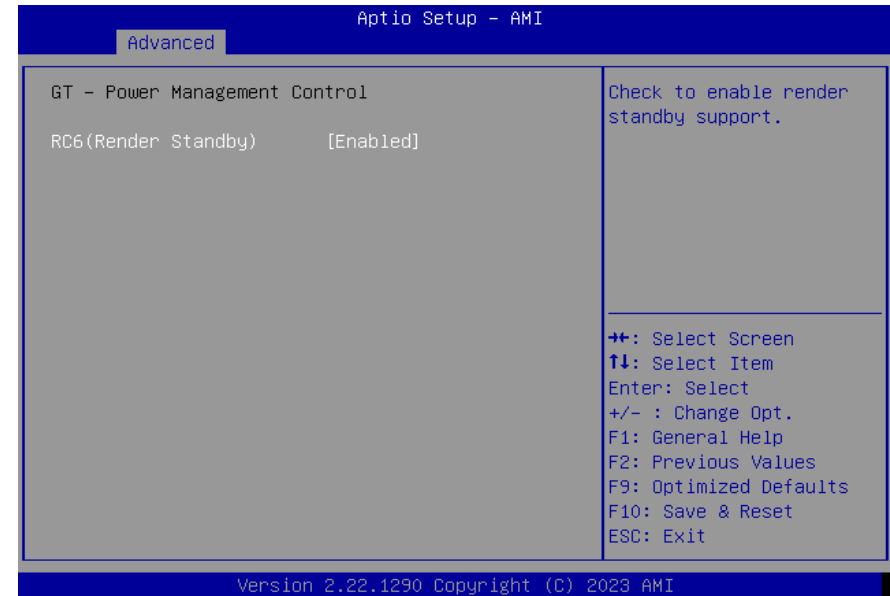

RC6 (Render Standby)

Check to enable render standby support.

► Advanced

PCH-FW Configuration

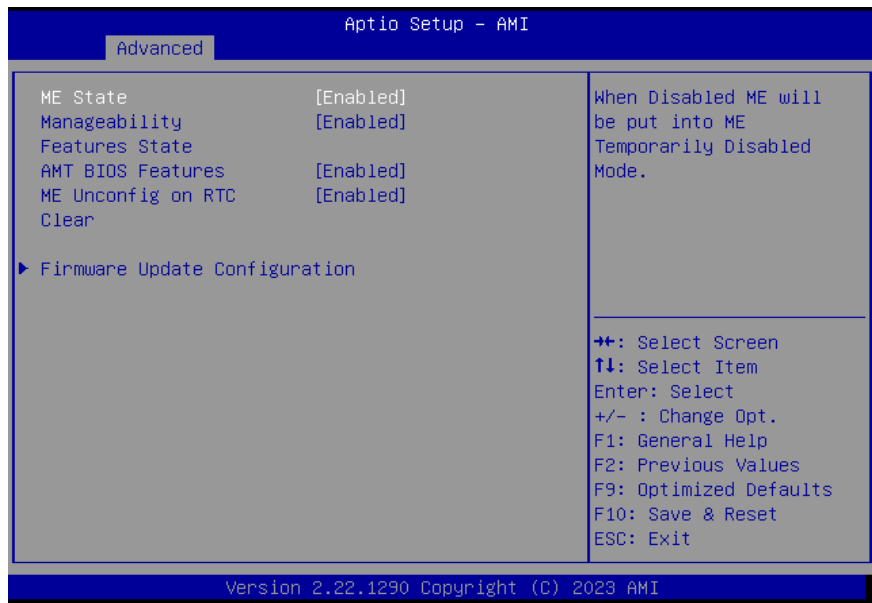

ME State

When this field is set to Disabled, ME will be put into ME Temporarily Disabled Mode.

Manageability Features State

Enable or disable Intel(R) Manageability features. This option disables/enables Manageability Features support in FW. To disable, support platform must be in an unprovisioned state first.

AMT BIOS Features

When disabled, AMT BIOS features are no longer supported and user is no longer able to access MEBx Setup. This option does not disable manageability features in FW.

ME Unconfig on RTC Clear

When Disabled ME will not be unconfigured on RTC Clear.

Firmware Update Configuration

Configure Management Engine Technology Parameters.

► Advanced

Trusted Computing



Security Device Support

This field is used to enable or disable BIOS support for the security device such as an TPM 2.0 to achieve hardware-level security via cryptographic keys.

Pending operation

To clear the existing TPM encryption, select "TPM Clear" and restart the system. This field is not available when "Security Device Support" is disabled.

► Advanced

PTN3460 Configuration

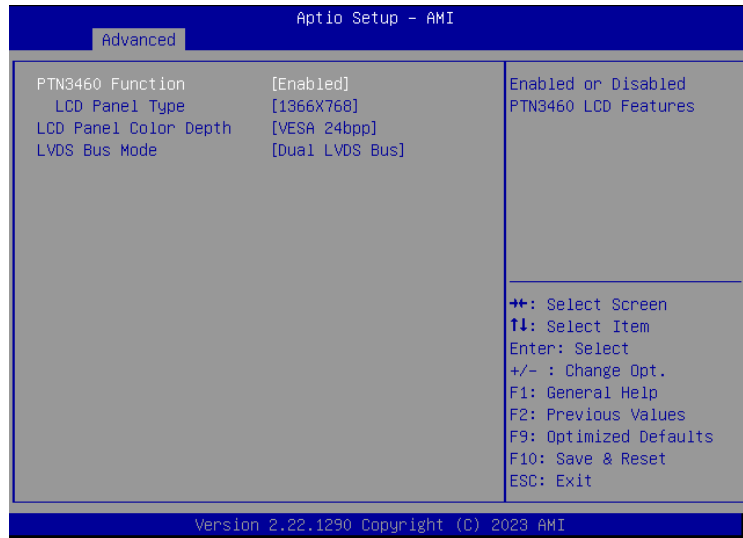

PTN3460 Function

Enable or Disable PTN3460 LCD Features. When this field is disabled, the following fields will remain hidden.

LCD Panel Type

Select the resolution of the LCD Panel – 800X480, 800X600, 1024X768, 1366X768, 1280X1024, 1920X1080, or 1920X1200.

LCD Panel Color Depth

Select the color depth of the LCD Panel – VESA 24bpp, JEIDA 24bpp, VESA and JEIDA 18 bpp.

LVDS Bus Mode

Select PTN3460 LVDS BUS Mode : Single LVDS Bus /Dual LVDS Bus

 **Note:**
The configuration must match the specifications of your LCD Panel in order for the LCD Panel to display properly.

► Advanced

NCT6126D Super IO Configuration

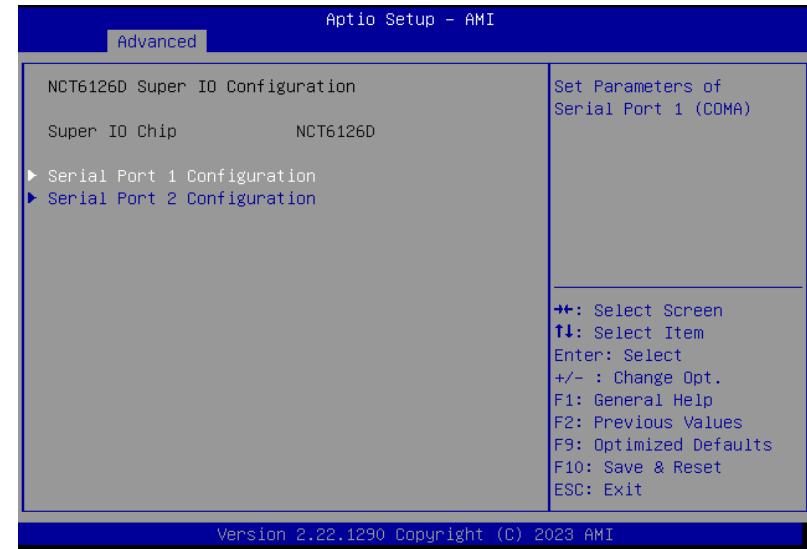

► Advanced

NCT6126D HW Monitor

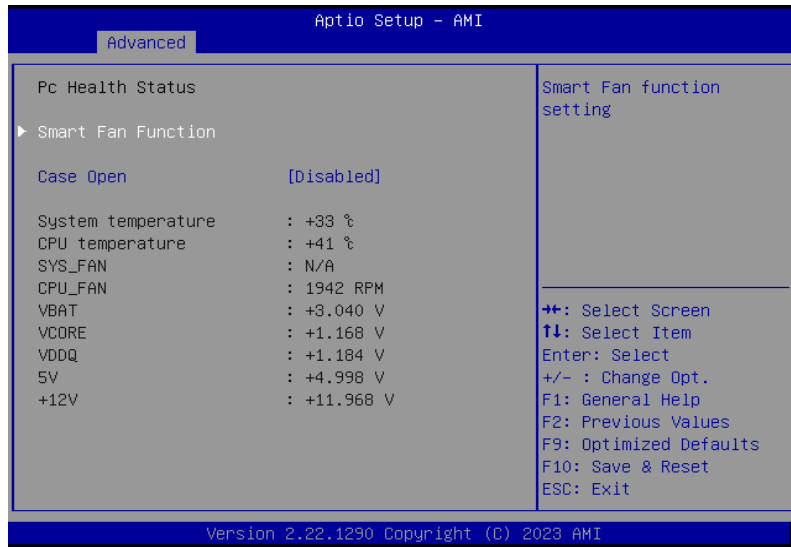

Smart Fan Function

Smart Fan Function Setting.

Case Open

Enable or disable the case open detection function.

► Advanced

NCT6126D HW Monitor ► Smart FAN Function

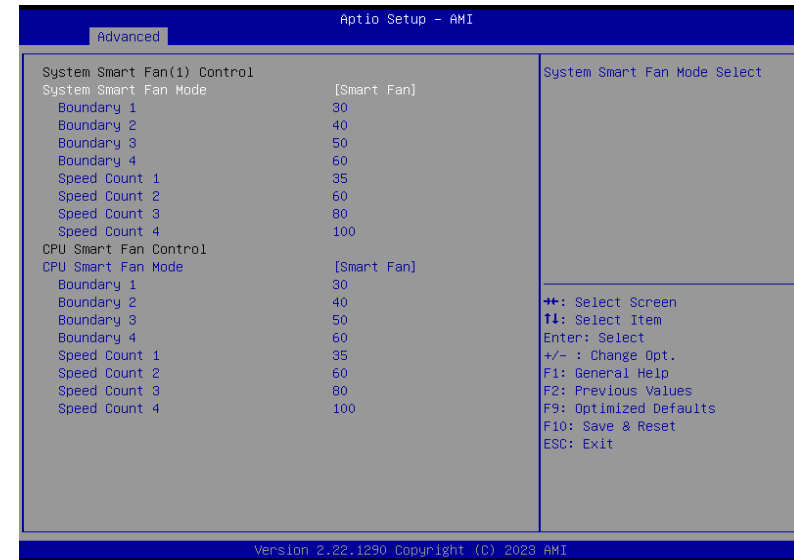

▼ CPU/SYS Smart Fan Mode = [Smart Fan]

Boundary 1 to Boundary 4

Set the boundary temperatures that determine the fan speeds accordingly, the value ranging from 0-127°C. For example, when the system temperature reaches Boundary 1 setting, the fan speed will be turned up to the designated speed of the Fan Speed Count 1 field.

Fan Speed Count 1 to Fan Speed Count 4

Set the fan speed, the value ranging from 1-100%, 100% being full speed. The fans will operate according to the specified boundary temperatures above-mentioned.

▼ CPU/SYS Smart Fan Mode = [Manual Mode]

Fix Fan Speed Count

Set the fan speed, the value ranging from 1-100%, 100% being full speed. The fans will always operate at the specified speed regardless of gauged temperatures.

► Advanced

Serial Port Console Redirection

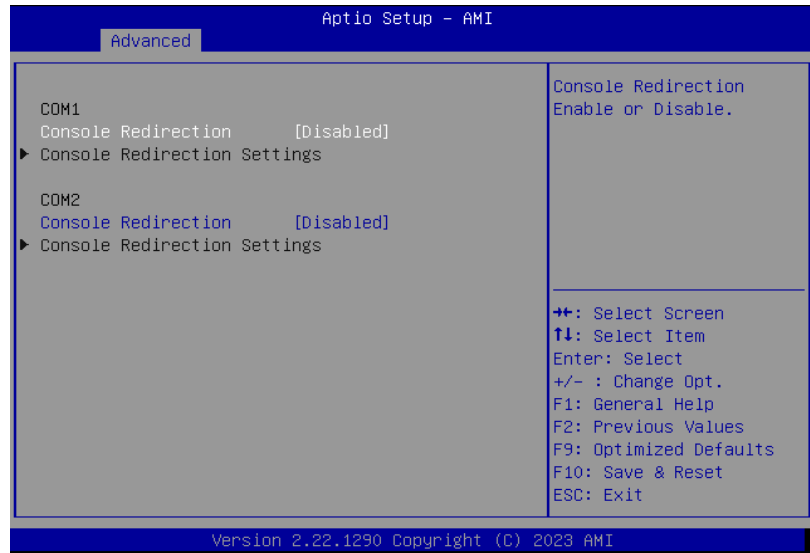

► Advanced

Serial Port Console Redirection ► Console Redirection Settings

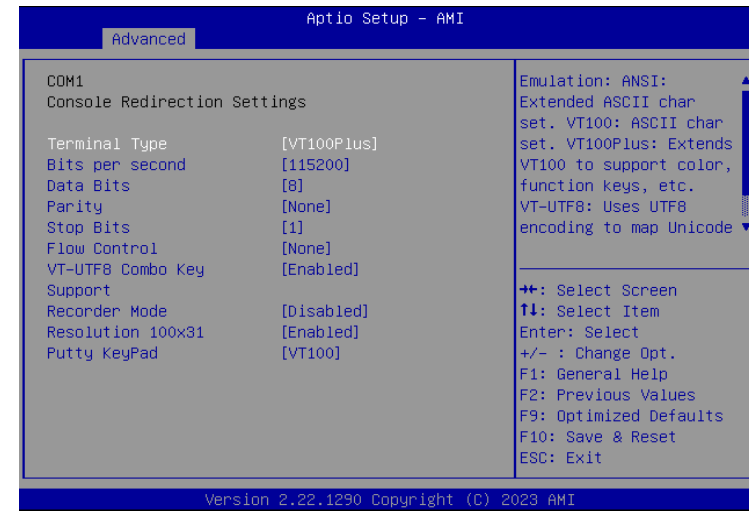

Console Redirection

By enabling Console Redirection of a COM port, the sub-menu of console redirection settings will become available for configuration as detailed in the following.

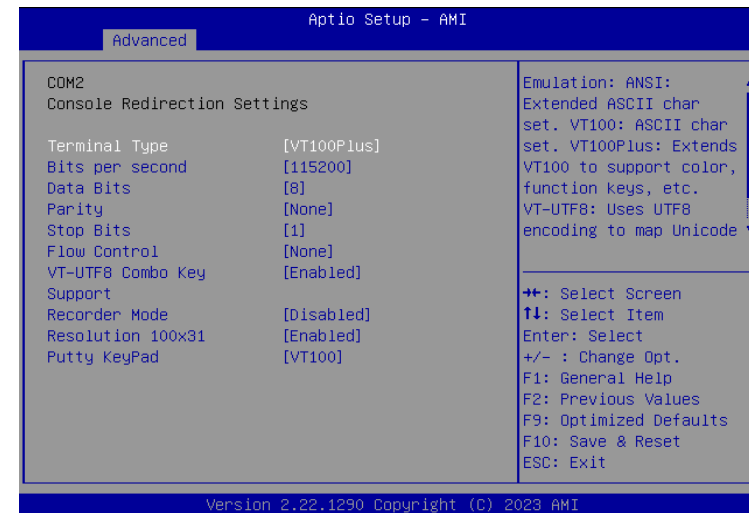

► **Advanced**

Terminal Type

Select terminal type: VT100, VT100+, VT-UTF8 or ANSI.

Bits per second

Select serial port transmission speed: 9600, 19200, 38400, 57600 or 115200.

Data Bits

Select data bits: 7 bits or 8 bits.

Parity

Select parity bits: None, Even, Odd, Mark or Space.

Stop Bits

Select stop bits: 1 bit or 2 bits.

Flow Control

Select flow control type: None or Hardware RTS/CTS. Flow Control is for RS485 mode.

VT-UTF8 Combo Key Support

Enable VT-UTF8 Combination Key Support for ANSI/VT100 terminals.

Recorder Mode

With this mode enabled only text will be sent. This is to capture Terminal data.

Resolution 100x31

Enables or disables extended terminal resolution

Putty KeyPad

Select FunctionKey and KeyPad on Putty.

► **Advanced**

ACPI Settings

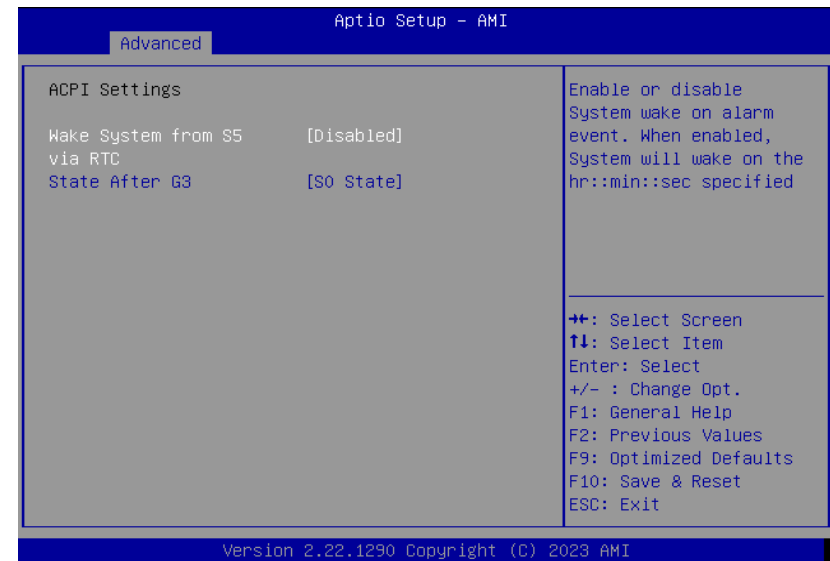

Wake system from S5 via RTC

When Enabled, the system will automatically power up at a designated time every day. Once it's switched to [Enabled], please set up the time of day – hour, minute, and second – for the system to wake up.

State After G3

Select between S0 State, and S5 State. This field is used to specify what state the system is set to return to when power is re-applied after a power failure (G3 state).

- **S0 State** The system automatically powers on after power failure.
- **S5 State** The system enter soft-off state after power failure. Power-on signal input is required to power up the system.
- **Last State** The system returns to the last state right before power failure.

► **Advanced**

Network Stack Configuration

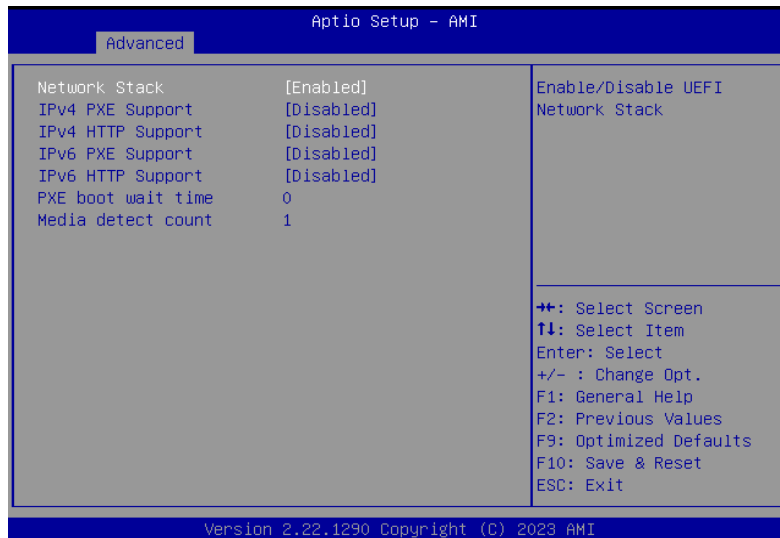

► **Advanced**

Network Stack

Enable or disable UEFI network stack. The following fields will appear when this field is enabled.

IPv4 PXE Support

Enable or disable IPv4 PXE boot support. If disabled, IPv4 PXE boot support will not be available.

IPv4 HTTP Support

Enable or disable IPv4 HTTP boot support. If disabled, IPv4 HTTP boot support will not be available.

IPv6 PXE Support

Enable or disable IPv6 PXE boot support. If disabled, IPv6 PXE boot support will not be available.

IPv6 HTTP Support

Enable or disable IPv6 HTTP boot support. If disabled, IPv6 HTTP boot support will not be available.

PXE boot wait time

Set the wait time in seconds to press ESC key to abort the PXE boot. Use either +/- or numeric keys to set the value.

Media detect count

Set the number of times the presence of media will be checked. Use either +/- or numeric keys to set the value.

▶ **Advanced**

NVMe Configuration



▶ **Advanced**

DFI WDT Configuration

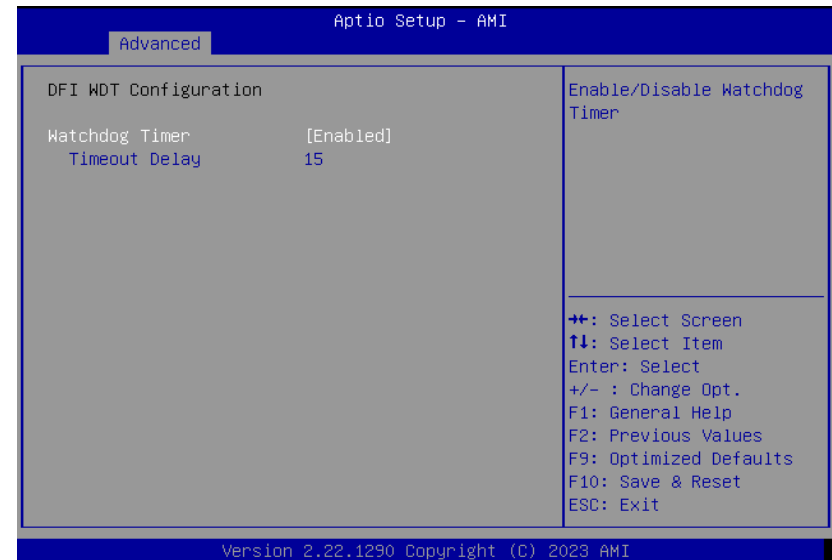

Watchdog Timer

Enable or disable Watchdog Timer.

▶ Advanced

USB Power Control

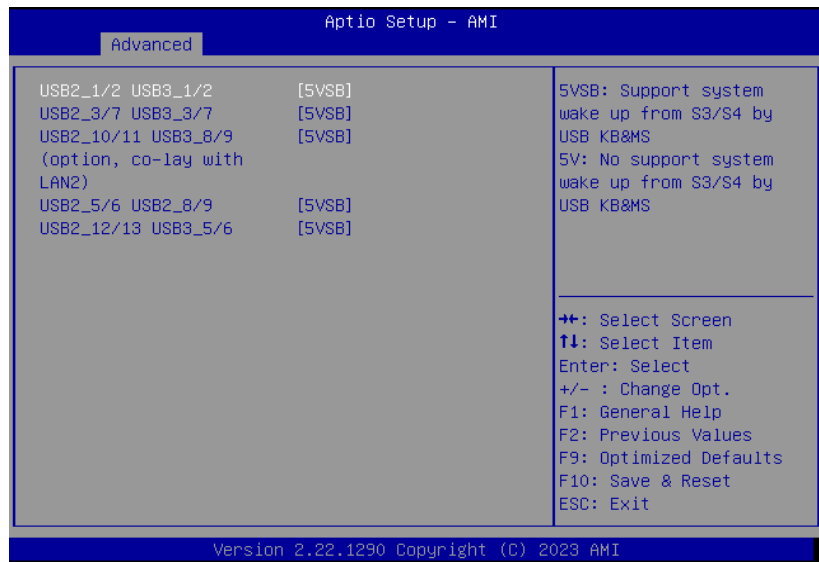

Server CA Configuration

5VSB: Support system wake up from S3/S4 by USB KB&MS
5V: No support system wake up from S3/S4 by USB KB&MS

▶ Advanced

Tls Auth Configuration

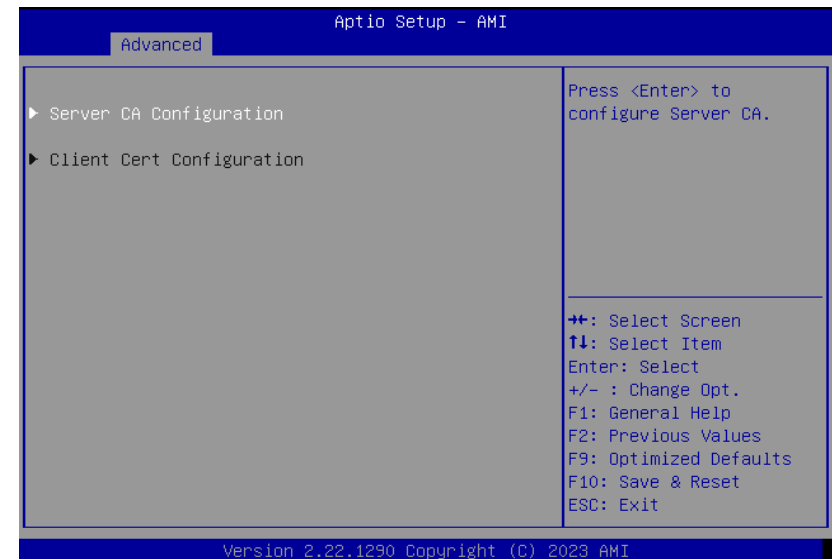

Server CA Configuration

Press <Enter> to configure Server CA.

► **Chipset**

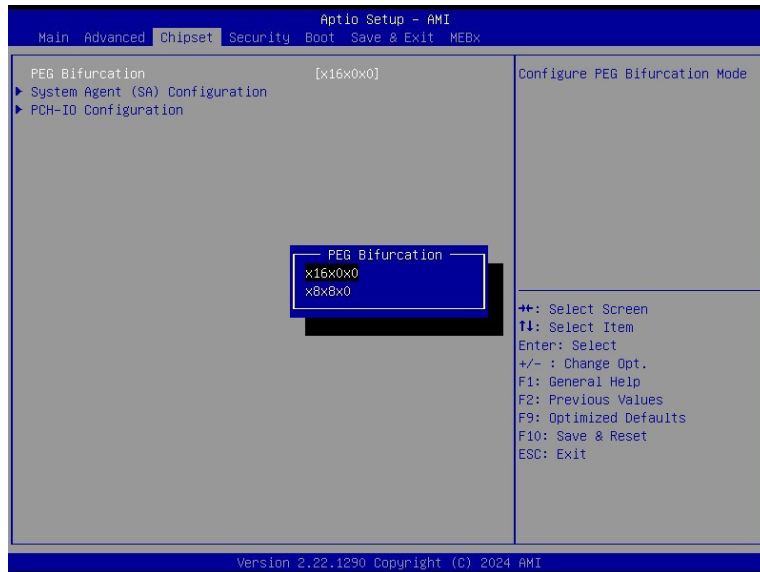

Please select a submenu and press Enter. The submenus are detailed in the following pages.

► **Chipset**

PEG Bifurcation

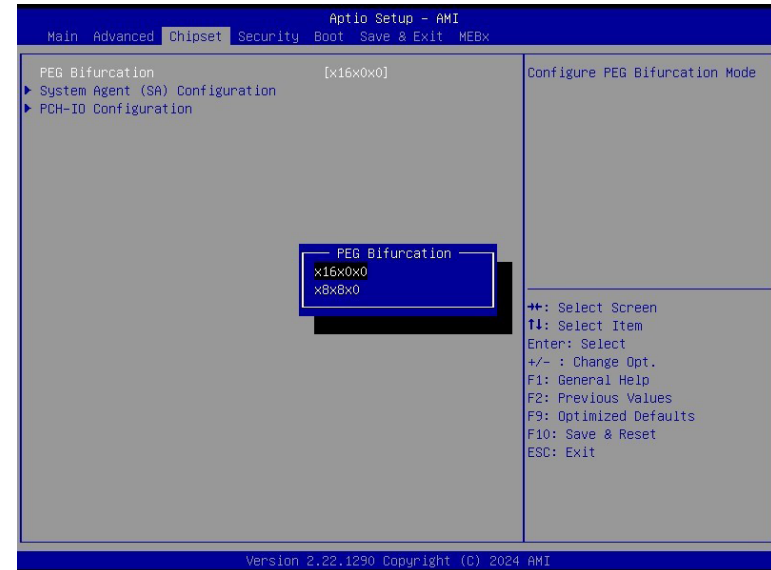

PEG Bifurcation

Configure PEG Bifurcation Mode.

▶ Chipset

System Agent (SA) Configuration

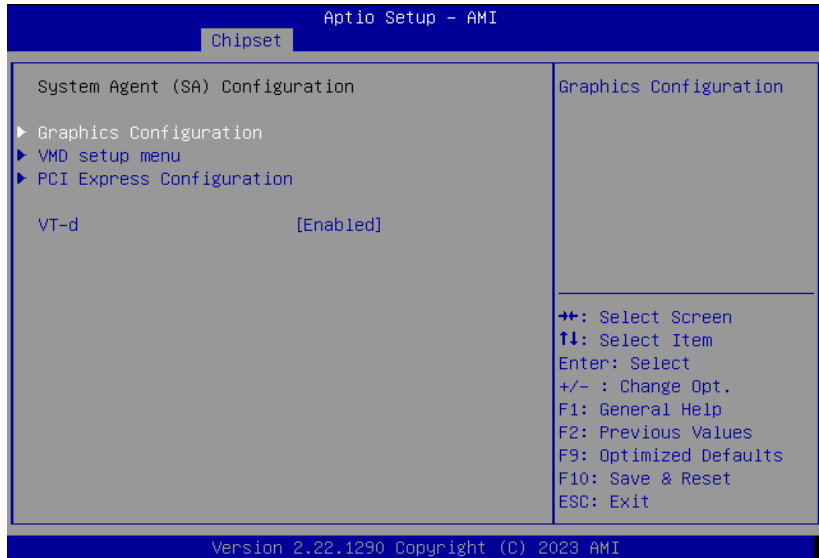

Graphics Configuration

Settings about graphic.

VMD setup menu

VMD Configuration Settings

PCI Express Configuration :

VT-d

VT-d capability.

X2APIC Opt Out

Enable/Disable X2APIC_OPT_OUT bit

DMA Control Guarantee

Enable/Disable DMA_Control_Guarantee bit

▶ Chipset

System Agent (SA) Configuration ▶ Graphics Configuration

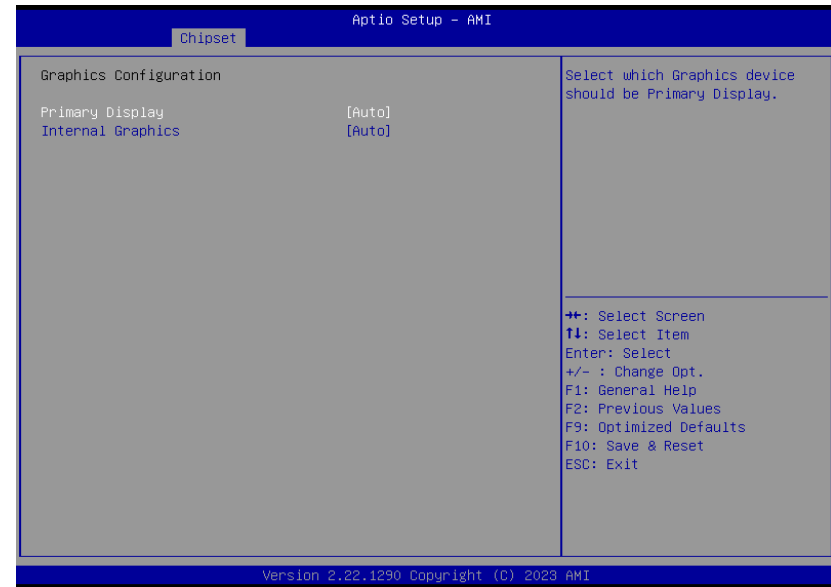

Primary Display

Select which of IGFX/PEG/PCI Graphics device to be the primary display.

Internal Graphics

Keep IGFX "Enabled" or "Disabled" based on the setup options, or select "Auto" for auto-detection.

► Chipset

PCH-IO Configuration

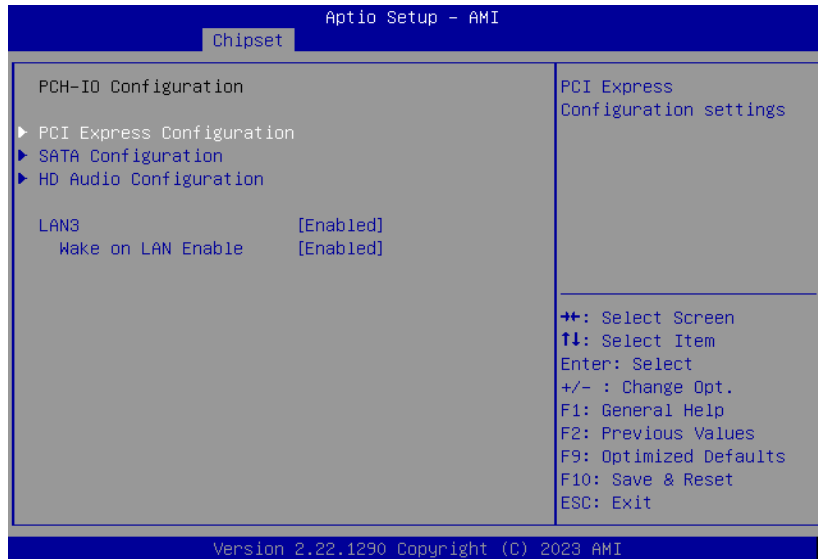

PCI Express Configuration

PCI Express Configuration Settings

SATA And RST Configuration

SATA Device Options Settings

HD Audio Configuration

HD Audio Subsystem Configuration Settings

► Chipset

PCH-IO Configuration ► PCI Express Configuration

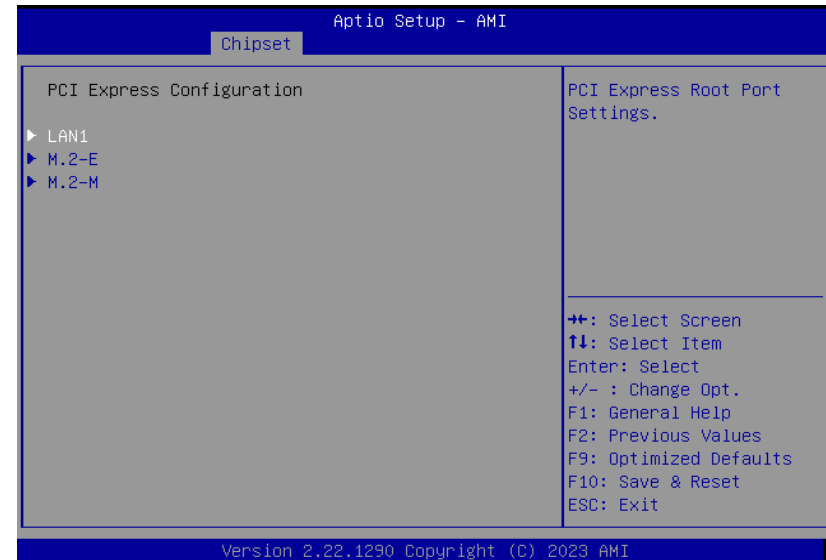

LAN1, M.2-E, M.2-M

Control the PCI Express Root Port.

► Chipset

PCH-IO Configuration ► SATA Configuration

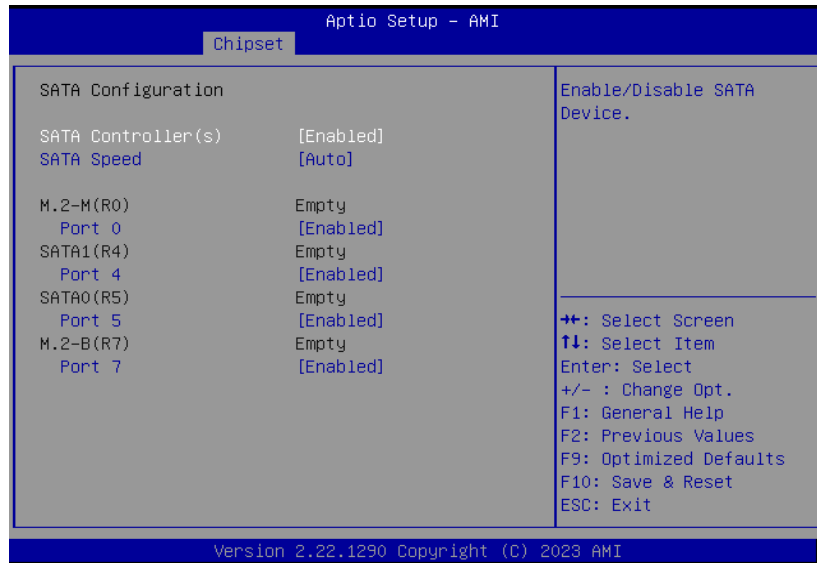

SATA Controller(s)

This field is used to enable or disable the Serial ATA controller.

SATA Speed

This field is used to select SATA speed generation limit: Auto, Gen1, Gen2 or Gen3.

Ports and Hot Plug

Enable or disable the Serial ATA port and its hot plug function.

► Chipset

PCH-IO Configuration ► HD Audio Configuration

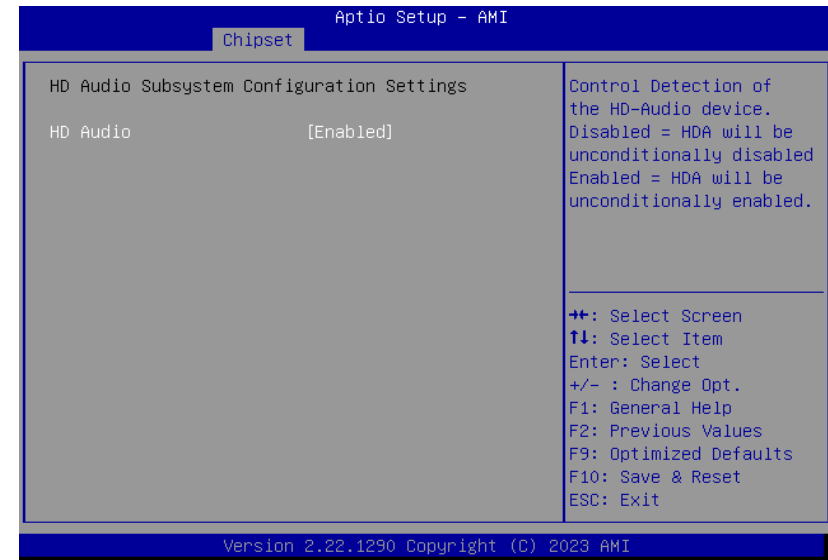

HD Audio

Control the detection of the HD Audio device.

- **Disabled** HDA will be unconditionally disabled.
- **Enabled** HDA will be unconditionally enabled.

► Security

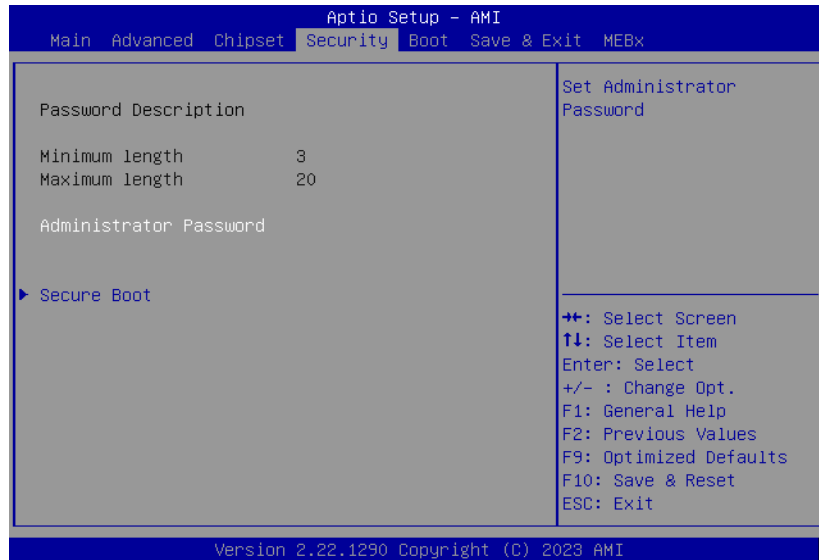

Administrator Password

Set the administrator password. To clear the password, input nothing and press enter when a new password is asked. Administrator Password will be required when entering the BIOS.

► Security

Secure Boot

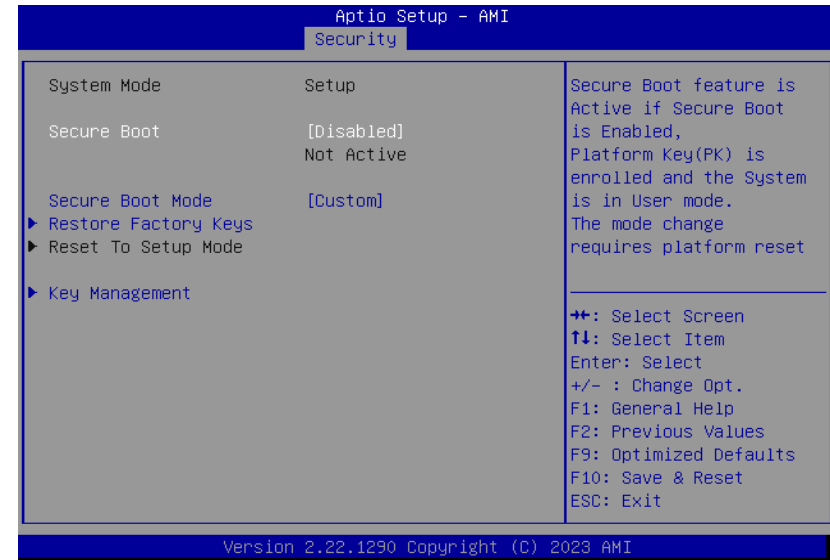

Secure Boot

The Secure Boot store a database of certificates in the firmware and only allows the OSes with authorized signatures to boot on the system. To activate Secure Boot, please make sure that “Secure Boot” is “[Enabled]”, Platform Key (PK) is enrolled, “System Mode” is “User”, and CSM is disabled. After enabling/disabling Secure Boot, please save the configuration and restart the system. When configured and activated correctly, the Secure Boot status will be “Active”.

Secure Boot Mode

Select the secure boot mode — Standard or Custom. When set to Custom, the following fields will be configurable for the user to manually modify the key database.

Restore Factory Keys

Force system to User Mode. Load OEM-defined factory defaults of keys and databases onto the Secure Boot. Press Enter and a prompt will show up for you to confirm.

Reset To Setup Mode

Clear the database from the NVRAM, including all the keys and signatures installed in the Key Management menu. Press Enter and a prompt will show up for you to confirm.

Key Management

Enables expert users to modify Secure Boot Policy variables without full authentication.

► Boot

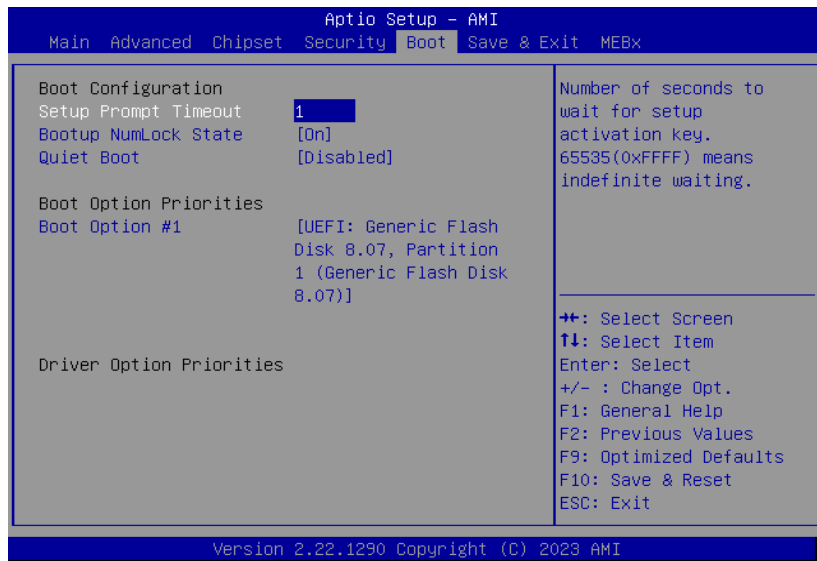

Setup Prompt Timeout

Set the number of seconds to wait for the setup activation key. 65535 (0xFFFF) denotes indefinite waiting.

Bootup NumLock State

Select the keyboard NumLock state: On or Off.

Quiet Boot

This section is used to enable or disable quiet boot option.

Boot Option Priorities

Rearrange the system boot order of available boot devices.

Fast Boot

Enables or disables boot with initialization of a minimal set of devices required to launch active boot option. Has no effect for BBS boot options.

Note:
If "Boot option filter" of "CSM Configuration" is set to "UEFI and Legacy" or "UEFI only", and "Quiet Boot" is set to enabled, "BGRT Logo" will show up for configuration. Refer to the Advanced > CSM Configuration submenu for more information.

► Save & Exit

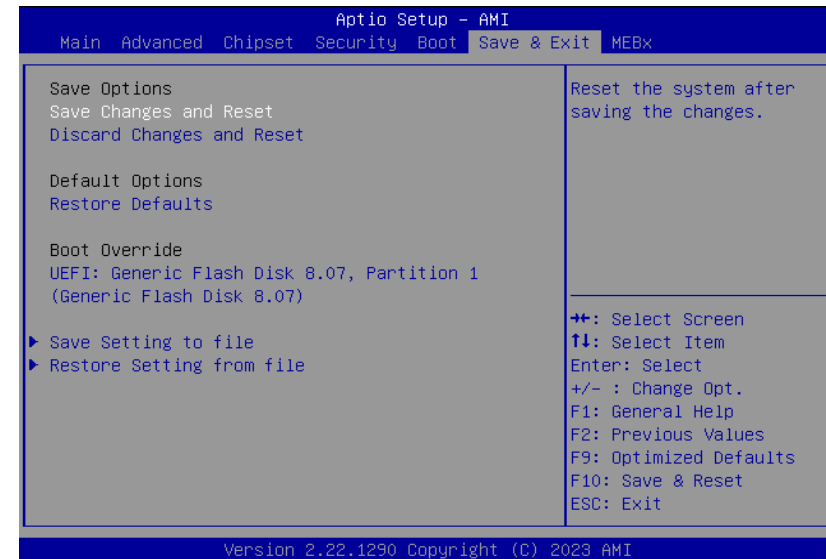

Save Changes and Reset

To save the changes, select this field and then press <Enter>. A dialog box will appear. Select Yes to reset the system after saving all changes made.

Discard Changes and Reset

To discard the changes, select this field and then press <Enter>. A dialog box will appear. Select Yes to reset the system setup without saving any changes.

Restore Defaults

To restore and load the optimized default values, select this field and then press <Enter>. A dialog box will appear. Select Yes to restore the default values of all the setup options.

Boot Override

Move the cursor to an available boot device and press Enter, and then the system will immediately boot from the selected boot device. The Boot Override function will only be effective for the current boot. The "Boot Option Priorities" configured in the Boot menu will not be changed.

• **Save Setting to file** Select this option to save BIOS configuration settings to a USB flash device.

• **Restore Setting from file** This field will appear only when a USB flash device is detected. Select this field to restore setting from the USB flash device.

Chapter 4 - RAID Settings

The system board allows configuring RAID on Serial ATA drives. It supports RAID 0, RAID 1, RAID 5 and RAID 10.

► RAID Levels

RAID 0 (Striped Disk Array without Fault Tolerance)

RAID 0 uses two new identical hard disk drives to read and write data in parallel, interleaved-stacks. Data is divided into stripes and each stripe is written alternately between two disk drives. This improves the I/O performance of the drives at different channel; however it is not fault tolerant. A failed disk will result in data loss in the disk array.

RAID 1 (Mirroring Disk Array with Fault Tolerance)

RAID 1 copies and maintains an identical image of the data from one drive to the other drive. If a drive fails to function, the disk array management software directs all applications to the other drive since it contains a complete copy of the drive's data. This enhances data protection and increases fault tolerance to the entire system. Use two new drives or an existing drive and a new drive but the size of the new drive must be the same or larger than the existing drive.

RAID 5

RAID 5 stripes data and parity information across hard drives. It is fault tolerant and provides better hard drive performance and more storage capacity.

RAID 10 (Mirroring and Striping)

RAID 10 is a combination of data striping and data mirroring providing the benefits of both RAID 0 and RAID 1. Use four new drives or an existing drive and three new drives for this configuration.

RAID Level	Min. Drives	Protection	Description
RAID 0	2	None	Data striping without redundancy
RAID 1	2	Single Drive Failure	Disk mirroring
RAID 5	3	Single Drive Failure	Block-level data striping with distributed parity
RAID 10	4	1 Disk Per Mirrored Stripe (not same mirror)	Combination of RAID 0 (data striping) and RAID 1 (mirroring)



Note:

M.2 PCIe SSD cannot be used to set up a RAID set either with an M.2 SATA SSD or a SATA hard drive.

► Setup Procedure

To enable the RAID function, the following settings are required.

1. Install SATA drives.
2. Enable RAID in the Insyde BIOS.
3. Create a RAID volume.
4. Install the Intel Rapid Storage Technology Utility.

Step 1: Install SATA Drives

Refer to chapter 2 for details on connecting the Serial ATA drives.



Important:

1. Please make sure the SATA drives that you are to create a RAID volume with are connected and powered, and are able to be detected by the system. Otherwise, the RAID BIOS utility would not be accessible.
2. While creating a RAID volume, please make sure the system, drives, and cables are perfectly steady and mounted correctly. Disturbance during creating a RAID volume will result in irreversible data corruption stored on the drive.

Step 2: Enable RAID in the AMI BIOS

1. Power-on the system then press to enter the main menu of the AMI BIOS.
2. Go to "Chipset" menu and select the "PCH-IO Configuration" menu then "SATA And RST Configuration" menu.
3. Change the "SATA Mode Selection" to "Intel RST Premium With Intel Optane System Acceleration" mode.
4. Press F10 to save the changes.
5. Reboot the system.

Step 3: Create a RAID Volume

1. Go to the "Advanced" menu of the AMI BIOS and select "Intel(R) Rapid Storage Technology".
2. The screen displays all available drives. Select "Create RAID volume" to create a RAID volume".
3. Use the up or down arrow keys to select the RAID level and press <Enter>.
4. Use the up or down arrow keys to scroll through the list of hard drives and press <Enter> to select the drive.
5. Press <Enter>.
6. Use the up or down arrow keys to select the strip size and press <Enter>.
7. Enter the volume size and press <Enter>.
8. At the prompt, press <Y> to confirm volume creation.

Step 4: Install the Intel Rapid Storage Technology Utility

The Intel Rapid Storage Technology Utility can be installed from within Windows. It allows RAID volume management (create, delete, migrate) from within the operating system. It will also display useful SATA device and RAID volume information. The user interface, tray icon service and monitor service allow you to monitor the current status of the RAID volume and/or SATA drives. It enables enhanced performance and power management for the storage sub-system.