



CS181

Mini-ITX Industrial Motherboard User's Manual

Copyright

This publication contains information that is protected by copyright. No part of it may be reproduced in any form or by any means or used to make any transformation/adaptation without the prior written permission from the copyright holders.

This publication is provided for informational purposes only. The manufacturer makes no representations or warranties with respect to the contents or use of this manual and specifically disclaims any express or implied warranties of merchantability or fitness for any particular purpose. The user will assume the entire risk of the use or the results of the use of this document. Further, the manufacturer reserves the right to revise this publication and make changes to its contents at any time, without obligation to notify any person or entity of such revisions or changes.

Changes after the publication's first release will be based on the product's revision. The website will always provide the most updated information.

© 2022. All Rights Reserved.

Trademarks

Product names or trademarks appearing in this manual are for identification purpose only and are the properties of the respective owners.

FCC and DOC Statement on Class B

This equipment has been tested and found to comply with the limits for a Class B digital device, pursuant to Part 15 of the FCC rules. These limits are designed to provide reasonable protection against harmful interference when the equipment is operated in a residential installation. This equipment generates, uses and can radiate radio frequency energy and, if not installed and used in accordance with the instruction manual, may cause harmful interference to radio communications. However, there is no guarantee that interference will not occur in a particular installation. If this equipment does cause harmful interference to radio or television reception, which can be determined by turning the equipment off and on, the user is encouraged to try to correct the interference by one or more of the following measures:

- Reorient or relocate the receiving antenna.
- Increase the separation between the equipment and the receiver.
- Connect the equipment into an outlet on a circuit different from that to which the receiver is connected.
- Consult the dealer or an experienced radio TV technician for help.

Notice:

1. The changes or modifications not expressly approved by the party responsible for compliance could void the user's authority to operate the equipment.
2. Shielded interface cables must be used in order to comply with the emission limits.

Table of Contents

Chapter 1 - Introduction	6
Specifications	6
Features	8
DDR4	8
Chapter 2 - Hardware Installation	9
Board Layout.....	9
System Memory	10
Installing the SO-DIMM Module	10
CPU.....	12
Installing the CPU	12
Jumper Settings	14
Clear CMOS Data (JP1)	14
M.2 Power (M2JP204)	15
LCD Panel Power (DPJP201).....	16
Panel Backlight Selection (DPJP202).....	17
eDP Panel Inverter Power Selection (DPJP203).....	18
Rear I/O Ports.....	19
Graphics Display.....	19
USB Ports	20
RJ45 LAN Ports.....	20
12V DC-In	21
Internal I/O Ports.....	22
CPU Fan.....	22
Battery	22
eDP	23
USB2_5/6.....	24
COM (Serial) Port	25
SATA (Serial ATA) and SATA Power	26
Front Panel.....	27
LPC	28
Digital I/O	28
DIO Power	29
Front Audio.....	29
Installing the M.2 Module	30
Installing the Mini PCIe Module	31
Chapter 3 - BIOS Settings	32
Overview	32
Main.....	33
Advanced	33
RC ACPI Configuration.....	34
CPU Configuration.....	34
Power & Performance	35
PCH-FW Configuration	35
Trusted Computing.....	38
NCT5525D Super IO Configuration	39
NCT5525D HW Monitor	40
Serial Port Console Redirection	41
USB Configuration	42
Network Stack Configuration.....	43

CSM Configuration	43
USB Power Control.....	44
Chipset	45
Graphics Configuration	45
PEG Port Configuration.....	46
PCH-IO Configuration	47
PCI Express Configuration	47
SATA And RST Configuration	48
HD Audio Configuration	49
Security	50
Secure Boot.....	50
Boot	52
Save & Exit	52
Updating the BIOS.....	53
Notice: BIOS SPI ROM.....	53

About this Manual

This manual can be downloaded from the website. The manual is subject to change and update without notice, and may be based on editions that do not resemble your actual products. Please visit our website or contact our sales representatives for the latest editions.

Warranty

1. Warranty does not cover damages or failures that arised from misuse of the product, inability to use the product, unauthorized replacement or alteration of components and product specifications.
2. The warranty is void if the product has been subjected to physical abuse, improper installation, modification, accidents or unauthorized repair of the product.
3. Unless otherwise instructed in this user's manual, the user may not, under any circumstances, attempt to perform service, adjustments or repairs on the product, whether in or out of warranty. It must be returned to the purchase point, factory or authorized service agency for all such work.
4. We will not be liable for any indirect, special, incidental or consequential damages to the product that has been modified or altered.

Static Electricity Precautions

It is quite easy to inadvertently damage your PC, system board, components or devices even before installing them in your system unit. Static electrical discharge can damage computer components without causing any signs of physical damage. You must take extra care in handling them to ensure against electrostatic build-up.

1. To prevent electrostatic build-up, leave the system board in its anti-static bag until you are ready to install it.
2. Wear an antistatic wrist strap.
3. Do all preparation work on a static-free surface.
4. Hold the device only by its edges. Be careful not to touch any of the components, contacts or connections.
5. Avoid touching the pins or contacts on all modules and connectors. Hold modules or connectors by their ends.



Important:

Electrostatic discharge (ESD) can damage your processor, disk drive and other components. Perform the upgrade instruction procedures described at an ESD workstation only. If such a station is not available, you can provide some ESD protection by wearing an antistatic wrist strap and attaching it to a metal part of the system chassis. If a wrist strap is unavailable, establish and maintain contact with the system chassis throughout any procedures requiring ESD protection.

Safety Measures

- To avoid damage to the system, use the correct AC input voltage range.
- To reduce the risk of electric shock, unplug the power cord before removing the system chassis cover for installation or servicing. After installation or servicing, cover the system chassis before plugging the power cord.

About the Package

The package contains the following items. If any of these items are missing or damaged, please contact your dealer or sales representative for assistance.

- 1 CS181 motherboard
- 1 Serial ATA data with power cable (Length: 300mm) A81-002013-000G
- 1 COM port cable (Length: 250mm, 1 COM port) A81-015011-001G
- 1 USB port cable (Length: 200mm) A81-001032-016G

The board and accessories in the package may not come similar to the information listed above. This may differ in accordance with the sales region or models in which it was sold. For more information about the standard package in your region, please contact your dealer or sales representative.

Optional Items

Item Name	Part Number	Description
I/O shield	TBD	
COM port cable	A81-015011-001G	Length: 250mm, 1 COM port
Serial ATA data cable	332-553001-005G	Length: 500mm
Serial ATA power cable	A81-002044-016G	Length: 300mm
Thermal solution	A71-103004-000G A71-103005-000G	For 35W, Height: 37.3mm For 65W, Height: 45.3mm
MXM Quadro P2000	612-EGXMXM-100G	58W, 0~55°C
MXM Quadro RTX 3000	612-M3T300-000G	80W, 0~55°C
Fan PWR Y-cable for MXM(RTX3000)	A81-009614-016G	1*3P/2.5mm to 1*3P/2.54mm to 1*4P/1.25mm, L=50mm
RTX3000 MXM COOLER	A71-110100-000G	87x106.35x34mm

The board and accessories in the package may not come similar to the information listed above. This may differ in accordance with the sales region or models in which it was sold. For more information about the standard package in your region, please contact your dealer or sales representative.

Before Using the System Board

When installing the system board in a new system, you will need at least the following internal components.

- CPU
- Memory module
- Storage device such as hard disk drive .
- Power adaptor

External system peripherals may also be required for navigation and display, including at least a keyboard, a mouse and a video display monitor.

Chapter 1 - Introduction

► Specifications

System	Processor	9th Generation Intel® Core™ Processors, LGA 1151 Socket, TDP up to 65W Intel® Core i7-9700E Processor (Core 8; Max speed 4.4 GHz; TDP 65W) Intel® Core i7-9700TE Processor (Core 8; Max speed 3.8 GHz; TDP 35W) Intel® Core i5-9500E Processor (Core 6; Max speed 4.2 GHz; TDP 65W) Intel® Core i5-9500TE Processor (Core 6; Max speed 3.6 GHz; TDP 35W) Intel® Core i3-9100E Processor (Core 4; Max speed 3.7 GHz; TDP 65W) Intel® Core i3-9100TE Processor (Core 4; Max speed 3.2 GHz; TDP 35W) 8th Generation Intel® Core™ Processors, LGA 1151 Socket, TDP up to 65W Intel® Core™ i7-8700 Processor (Core 6; Max speed 4.6 GHz; TDP 65W) Intel® Core™ i7-8700T Processor (Core 6; Max speed 4.0 GHz; TDP 35W) Intel® Core™ i5-8500 Processor (Core 6; Max speed 4.1 GHz; TDP 65W) Intel® Core™ i5-8500T Processor (Core 6; Max speed 3.5 GHz; TDP 35W) Intel® Core™ i3-8100 Processor (Core 4; Max speed 3.6 GHz; TDP 65W) Intel® Core™ i3-8100T Processor (Core 4; Max speed 3.1 GHz; TDP 35W) Intel® Pentium G5400 Processor (Core 2; Max speed 3.7 GHz; TDP 58W) Intel® Celeron G4900 Processor (Core 2; Max speed 3.1 GHz; TDP 54W)
	Chipset	Intel® Q370 Chipset
	Memory	Two 260-pin SODIMM up to 64GB Dual Channel DDR4 2400/2666MHz
	BIOS	AMI SPI 128Mbit
Graphics	Controller	Intel® UHD Graphics 630 (Pentium G5400 and Celeron G4900 support Intel® UHD Graphics 610)
	Feature	OpenGL 4.5, DirectX 12, OpenCL 2.1 HW Decode: AVC/H.264, MPEG2, VC1/WMV9, JPEG/MJPEG, HEVC/H265, VP8, VP9 HW Encode: AVC/H.264, MPEG2, JPEG, HEVC/H265, VP8, VP9
	Display	1 x eDP
		1 x DP++/HDMI (auto-detection)
		4 x DP (support by MXM Type-A/B module)
		eDP: resolution up to 4096x2304 @ 60Hz DP: resolution up to 4096x2304 @ 60Hz HDMI: resolution up to 4096x2160 @ 30Hz
Multiple Displays	Onboard: eDP + DP++/HDMI Onboard+MXM module: eDP + DP++/HDMI + DP + DP + DP + DP	
Expansion	Interface	1 x MXM Type-A/B/B+/C (support MXM module) (provide 4 x independent DP at rear side) 1 x M.2 2280 M Key (PCIe Gen3 x4/SATA 3.0)(support NVMe and Intel® Optane memory) 1 x M.2 3042/3052 B Key (PCIe Gen3 x1 / USB 3.2 Gen1) (support 5G or storage module) 1 x M.2 2230 E Key (USB2.0/PCIe Gen3 x1) (support BT/Wi-Fi module)
	Audio	Audio Codec Realtek ALC888S-VD2-GR
	Ethernet	Controller 1 x Intel® I219LM PHY (10/100/1000Mbps)

Rear I/O	Ethernet	4 x GbE (RJ-45)
	USB	4 x USB 3.2 Gen2 (dual type-A connector)
	Power	1 x DC Jack (mini-DIN)
	Display	1 x DP++/HDMI (auto-detection)
Internal I/O	Serial	2 x RS232/RS422/RS485, Select by BIOS
	Display	1 x eDP
		1 x LCD/Inverter Power
	Audio	1 x Front Audio (2 x 5 10-pin 2.00mm pitch header)
	USB	2 x USB 2.0 (2 x 5 10-pin 2.00mm pitch header)
	SATA	2 x SATA 3.0 (up to 6Gb/s)
		RAID 0/1/5
	DIO	1 x 8-bit DIO (1 x 8 8-pin 2.00mm pitch header)
1 x DIO Power (1x 4 4-pin 2.00mm pitch header)		
LPC	1 x LPC (2 x 7 14-pin 2.00mm pitch female header)	
SMBus	1 x SMBus	
Watchdog Timer	Output & Interval	System Reset, Programmable via Software from 1 to 255 Seconds
Security	TPM	dTPM2.0 (default)
Power	Type	Single 19V +/-5% DC
	Connector	DC-in Jack (mini-DIN)
	Consumption	Idle: i7-8700 65W: 19V @ 0.91A (17.29W)
		Max: i7-8700 65W: 19V @ 7.34A (139.46W)
RTC Battery	CR2032 Coin Cell	
OS Support	Microsoft	Windows 10 IoT Enterprise 64-bit
Environment	Temperature	Operating: -5 to 65°C
		Storage: -40 to 85°C
	Humidity	Operating: 5 to 90% RH
Storage: 5 to 90% RH		
MTBF	538,449 hrs @ 25°C; 324,118 hrs @ 45°C; 213,302 hrs @ 60°C; Calculation model: Telcordia Issue 4 Environment: GB, GC – Ground Benign, Controlled	
Mechanism	Dimensions	195mm (7.7") x 170mm (6.7")
	Height	PCB: 1.6mm
		Top Side: 26mm, Bottom Side: 10mm
STANDARD AND CERTIFICATIONS	Certification	CE, FCC, RoHS

► Features

Watchdog Timer

The Watchdog Timer function allows your application to regularly “clear” the system at the set time interval. If the system hangs or fails to function, it will reset at the set time interval so that your system will continue to operate.

DDR4

DDR4 delivers increased system bandwidth and improves performance. The advantages of DDR4 provide an extended battery life and improve the performance at a lower power than DDR3/DDR2.

Graphics

The integrated Intel® UHD graphics engine delivers an excellent blend of graphics performance and features to meet business needs. It provides excellent video and 3D graphics with outstanding graphics responsiveness. These enhancements deliver the performance and compatibility needed for today's and tomorrow's business applications.

Serial ATA

Serial ATA is a storage interface that is compliant with SATA 1.0a specification. With speed of up to 6Gb/s (SATA 3.0), it improves hard drive performance faster than the standard parallel ATA whose data transfer rate is 100MB/s.

Gigabit LAN

The Intel® I219V and Intel® I210AT Gigabit Ethernet Controllers support data transmission at 1Gbps.

Audio

The Realtek ALC888-S audio codec provides 7.1 channel High Definition audio output.

Wake-On-LAN

This feature allows the network to remotely wake up a Soft Power Down (Soft-Off) PC. It is supported via the onboard LAN port or via a PCI LAN card that uses the PCI PME (Power Management Event) signal. However, if your system is in the Suspend mode, you can power-on the system only through an IRQ or DMA interrupt.

Wake-On-USB

This function allows you to use a USB keyboard or USB mouse to wake up a system from the S3 (STR - Suspend To RAM) state.

ACPI STR

The system board is designed to meet the ACPI (Advanced Configuration and Power Interface) specification. ACPI has energy saving features that enables PCs to implement Power Management and Plug-and-Play with operating systems that support OS Direct Power Management. ACPI when enabled in the Power Management Setup will allow you to use the Suspend to RAM function.

With the Suspend to RAM function enabled, you can power-off the system at once by pressing the power button or selecting “Standby” when you shut down Windows® without having to go through the sometimes tiresome process of closing files, applications and operating system.

This is because the system is capable of storing all programs and data files during the entire operating session into RAM (Random Access Memory) when it powers-off. The operating session will resume exactly where you left off the next time you power-on the system.

Power Failure Recovery

When power returns after an AC power failure, you may choose to either power-on the system manually or let the system power-on automatically.

RTC Timer

The Real Time Clock (RTC) installed on the system board allows your system to automatically power-on on the set date and time.

Chapter 2 - Hardware Installation

► Board Layout

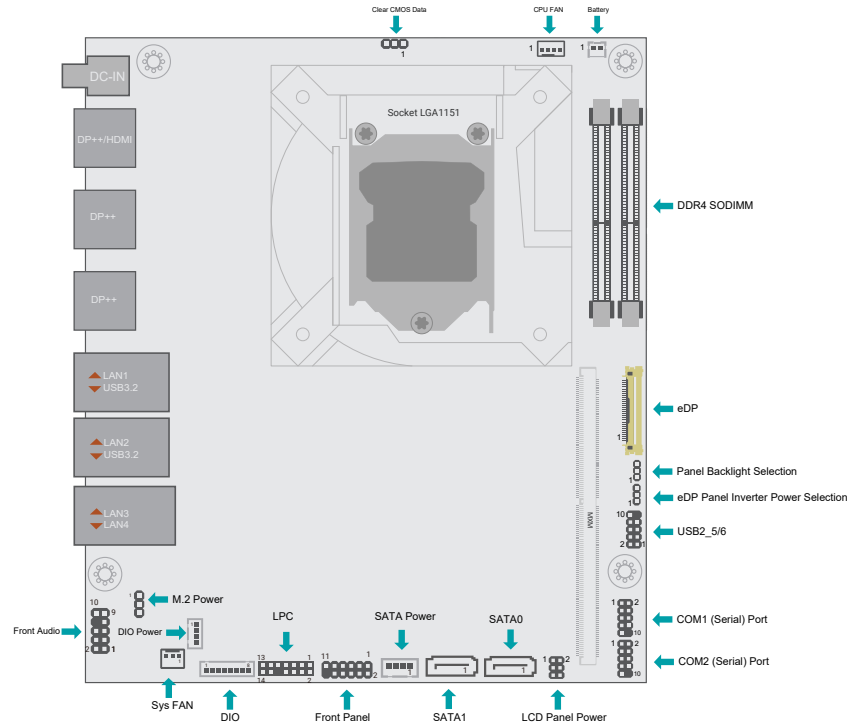

Note:

Specifications of these components are model-specific. Please refer to the specifications for detail.



Important:

Electrostatic discharge (ESD) can damage your board, processor, disk drives, add-in boards, and other components. Perform installation procedures at an ESD workstation only. If such a station is not available, you can provide some ESD protection by wearing an antistatic wrist strap and attaching it to a metal part of the system chassis. If a wrist strap is unavailable, establish and maintain contact with the system chassis throughout any procedures requiring ESD protection.

► System Memory

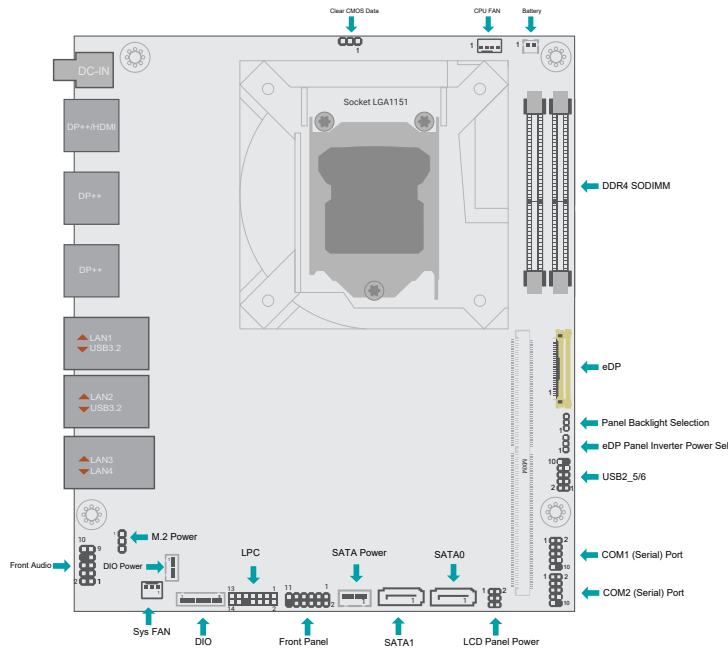

The system board supports one dual channel DDR4 SO-DIMM memory module.

Single Channel (SC)

Data will be accessed in chunks of 64 bits from the memory channels.

Dual Channel (DC)

Data will be accessed in chunks of 128 bits from the memory channels. Dual channel provides better system performance because it doubles the data transfer rate.

Features

- 260-pin SO-DIMM up to 64GB
- DDR4 2400/2666MHz

► System Memory

Installing the SO-DIMM Module

Before installing the memory module, please make sure that the following safety cautions are well-attended.

1. Make sure the PC and all other peripheral devices connected to it has been powered down.
2. Disconnect all power cords and cables.
3. Locate the SO-DIMM socket on the system board
4. Make sure the notch on memory card is aligned to the key on the socket.

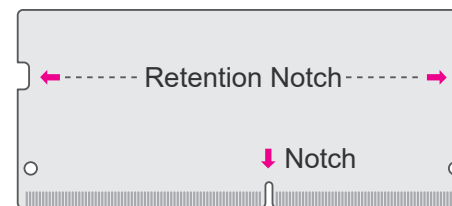

◀◀◀ **DDR4 SO-DIMM**

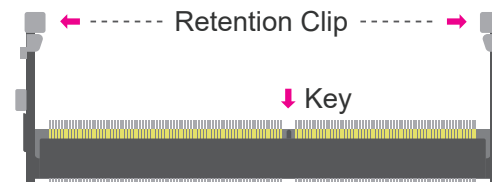

◀◀◀ **Socket Top View**

Please follow the steps below to install the memory card into the socket.

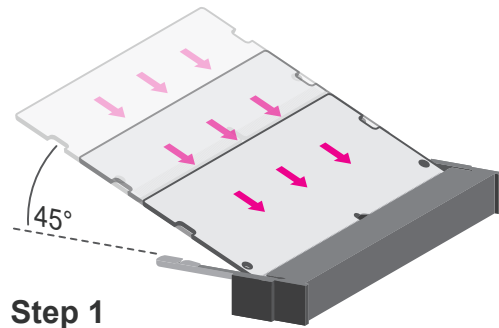

Step 1:
Insert the memory card into the slot while making sure 1) the notch and the key are aligned, and 2) the non-connector end rises approximately 45 degrees horizontally. Press the card firmly into the socket while applying and maintaining even pressure on both ends.

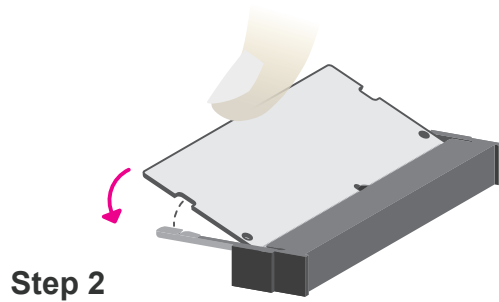

Step 2:
Press the end of the card far from the socket down while making sure the retention notch and the clip align as indicated by the dotted line in the illustration. If the retention notch and the clip do not align, please remove the card and re-insert it. Press the card all the way down.

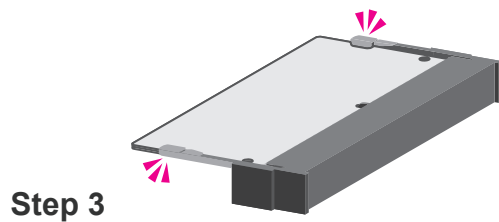

Step 3:
The clips snap automatically and abruptly to the retention notches of the card sounding a distinctive click, and lock the card in place. Inspect that the clip sits in the notch. If not, please pull the clips outward, release and remove the card, and mount it again.

► CPU

The system board is equipped with a surface mount LGA 1151 socket. This socket is exclusively designed for installing a LGA 1151 packaged Intel CPU.



Important:

1. Before you proceed, make sure (1) the LGA 1151 socket comes with a protective cap, (2) the cap is not damaged and (3) the socket's contact pins are not bent. If the cap is missing or the cap and/or contact pins are damaged, contact your dealer immediately.
2. Make sure to keep the protective cap. RMA requests will be accepted and processed only if the LGA 1151 socket comes with the protective cap.

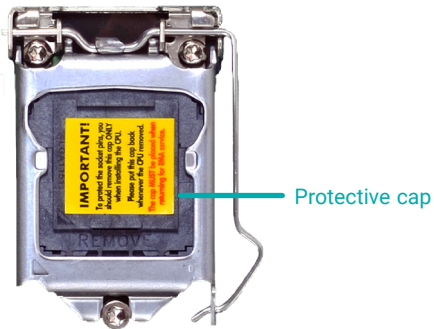

Note:

The system board used in the following illustrations may not resemble the actual board. These illustrations and photos are for reference only.

Installing the CPU

1. Make sure the PC and all other peripheral devices connected to it have been powered down.
2. Disconnect all power cords and cables.
3. Locate the LGA 1151 CPU socket on the system board.



Important:

The CPU socket must not come in contact with anything other than the CPU. Avoid unnecessary exposure. Remove the protective cap only when you are about to install the CPU.

4. Unlock the socket by pressing the load lever down, moving it sideways until to escape the retention tab. Lift the load lever up when it's released.

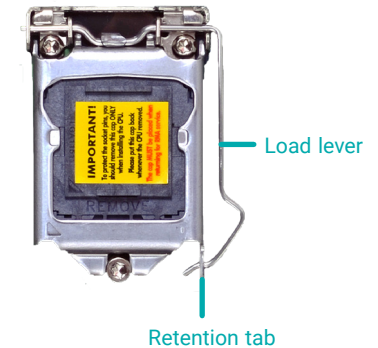

► CPU ► Installing the CPU

5. Lift the load lever and the load plate all the way up as shown in the photo.

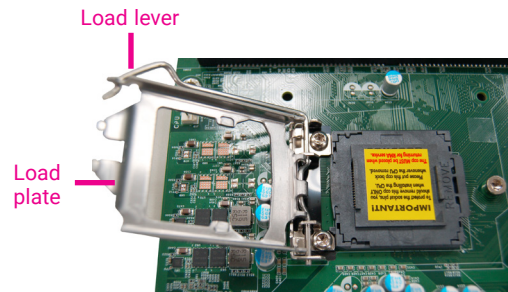

6. Remove the protective cap from the CPU socket. The cap is used to protect the CPU socket against dust and harmful particles. Remove the protective cap only when you are about to install the CPU.



7-1. Insert the CPU into the socket. The gold triangular mark on the CPU must align with the chamfer corner of the CPU socket shown in the photo.



Important:
The CPU will fit in only one orientation and can easily be seated without exerting any force.

► CPU ► Installing the CPU

7-2. Two keys on the socket and notches on the CPU also facilitate alignment.

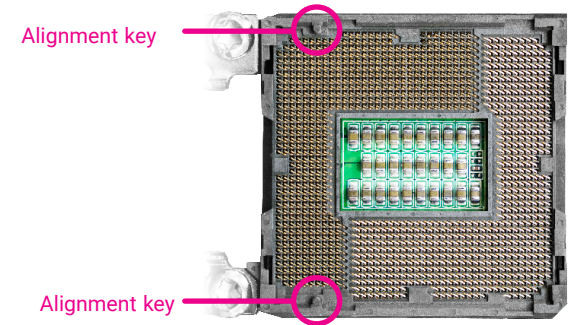

7-3. The CPU's notch will fit into the socket's alignment key when it's seated in the correct orientation.

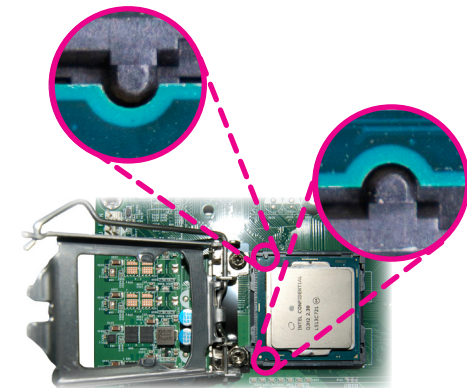

8. Close the load plate then push the load lever down.

While closing the load plate, make sure the front edge of the load plate slides under the retention knob.

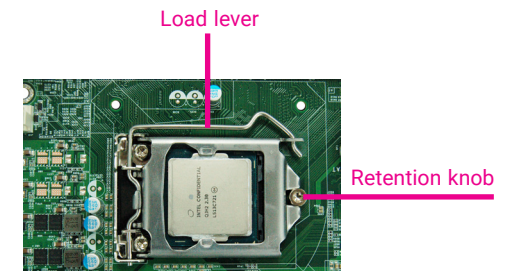

9. Press down the load lever and hook it under the retention tab.

► Jumper Settings

Clear CMOS Data (JP1)

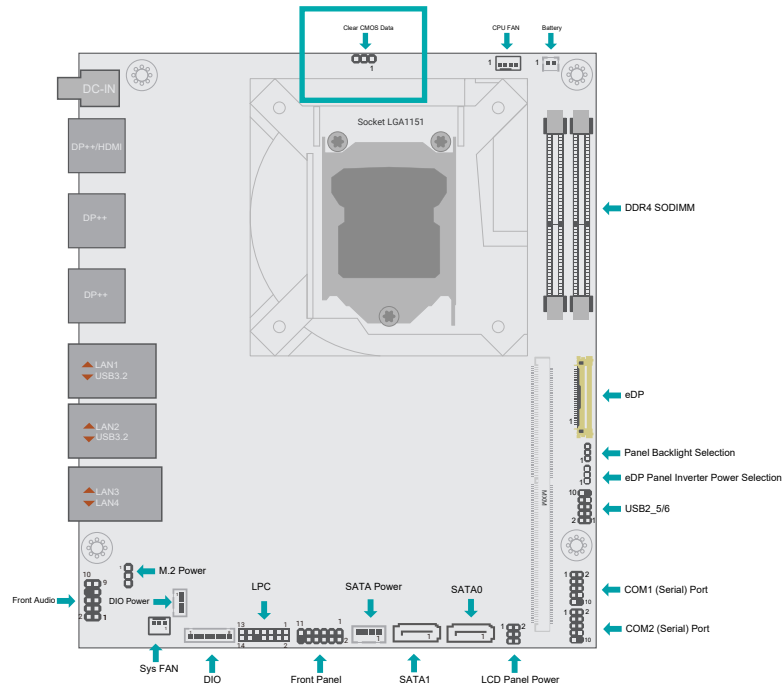

Function	Block
Normal (default)	1-2 On
Clear CMOS Data	2-3 On

- If any anomaly of the followings is encountered –
- a) CMOS data is corrupted;
 - b) you forgot the supervisor or user password;
 - c) failure to start the system due to BIOS mis-configuration

- it is suggested that the system be reconfigured with default values stored in the ROM BIOS. To load the default values stored in the ROM BIOS, please follow the steps below.
1. Power-off the system and unplug the power cord.
 2. Put a jumper cap on pin 2 and pin 3. Wait for a few seconds and set it back to its default setting, i.e. jumper cap on pin 1 and pin 2.
 3. Plug the power cord and power-on the system.

▶ Jumper Settings

M.2 Power (M2JP204)

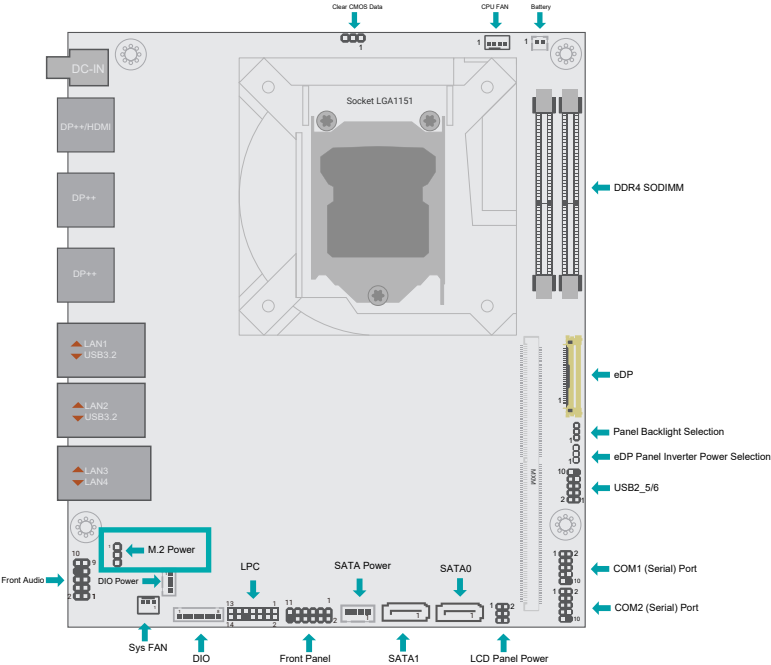

Function	Block
3V3SB (default)	1-2 On
3V3	2-3 On

This jumper is to switch M.2 Power output type.

▶ Jumper Settings

LCD Panel Power (DPJP201)

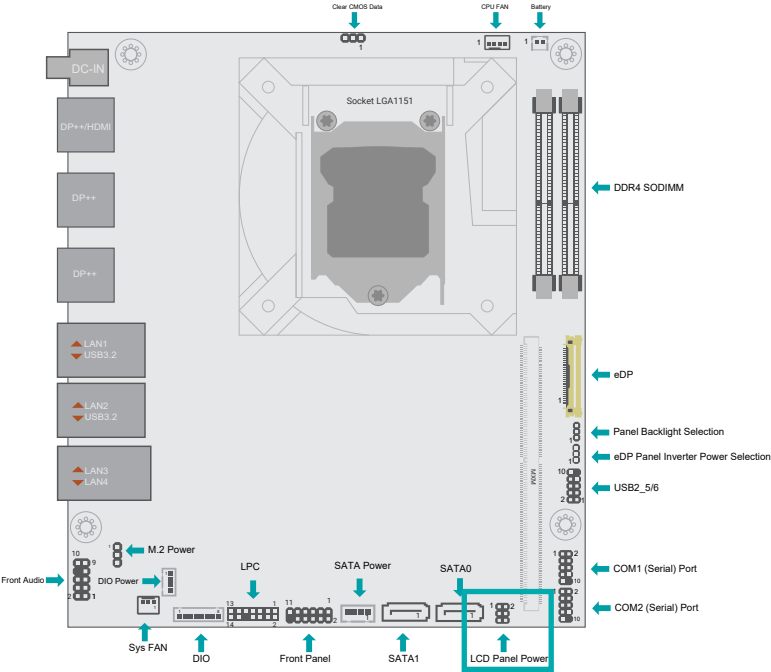

Function	Block
12V	1-2 On
5V	3-4 On
3V3 (default)	5-6 On

This jumper is to select LCD Panel Power output type.

► Jumper Settings

Panel Backlight Selection (DPJP202)

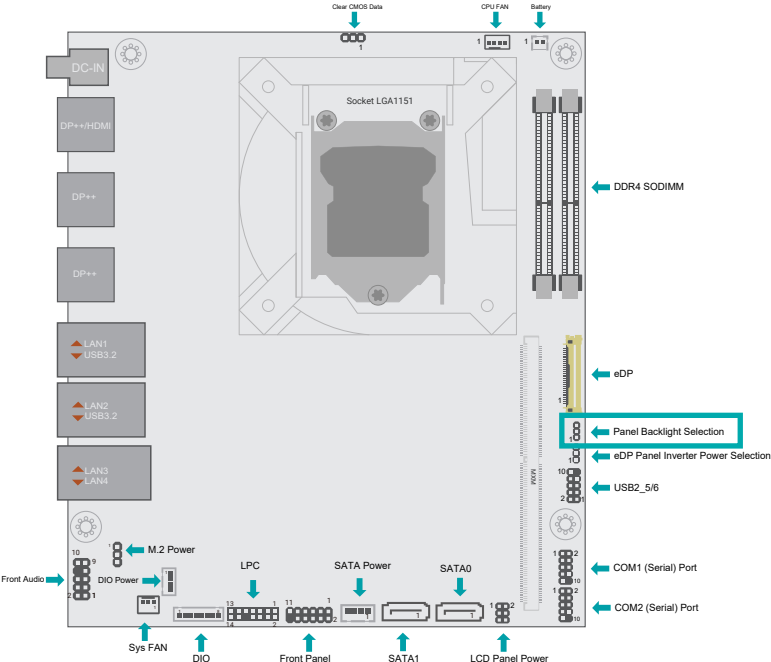

Function	Block
3V3 (default)	1-2 On
5V	2-3 On

This jumper is to determine the type of Panel Backlight Selection.

▶ Jumper Settings

eDP Panel Inverter Power Selection (DPJP203)

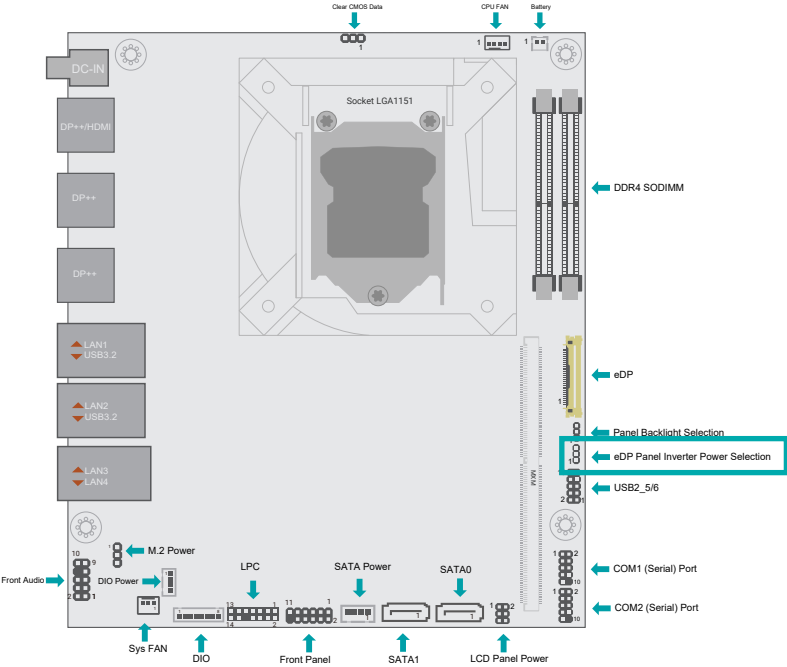

Function	Block
12V	1-2 On
5V (Default)	2-3 On

This jumper is to switch eDP Panel Inverter Power Selection output type.

► Rear I/O Ports



The rear panel I/O ports consist of the following:

- 4 DP++ ports
- 1 DC-In
- 4 RJ45 LAN ports
- 4 USB 3.2 ports
- 1 HDMI

► Rear I/O Ports

Graphics Display



DisplayPort ++

The DisplayPort (DP) is a digital display interface used to connect a display device such as a computer monitor. It is used to transmit audio and video simultaneously. The interface, which is developed by VESA, delivers higher performance features than any other digital interface.

HDMI

The HDMI port which carries both digital audio and video signals is used to connect a LCD monitor or digital TV that has the HDMI port.

► Rear I/O Ports

USB Ports



USB allows data exchange between your computer and a wide range of simultaneously accessible external Plug and Play peripherals. The system board is equipped with multiple USB Type A ports at the rear side.

Wake-On-USB Keyboard/Mouse

The Wake-On-USB Keyboard/Mouse function allows you to use a USB keyboard or USB mouse to wake up a system from the S3 (STR - Suspend To RAM) state.

► Rear I/O Ports

RJ45 LAN Ports



The LAN ports allow the system board to connect to a local area network by means of a network hub.

► Rear I/O Ports

19V DC-In



Connect a 4-pin DC power cord to the power connector for DC supply.



Important:

Using a voltage higher than the recommended range may result in failure in starting and booting the system or causing irreversible damage to the system board. A power adaptor/converter is necessary when the power source on site does not comply with the power specifications of the board.

► Internal I/O Ports

CPU Fan

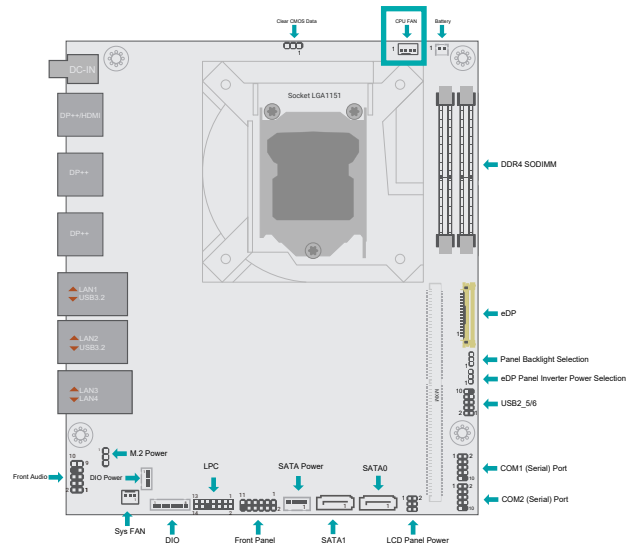

These fan connectors are used to connect to cooling fans. Cooling fans provide adequate air circulation throughout the chassis and dissipate heat to prevent overheating of the system board and components.

■ 4-pin Fan Pin Assignment

Pin	Assignment
1	Ground
2	12V
3	RPM
4	CTRL

► Internal I/O Connectors

Battery

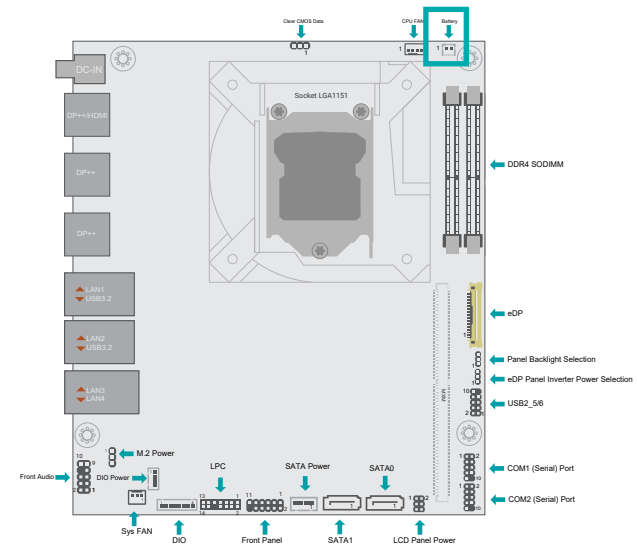

The external lithium ion battery supplies power to the real-time clock and CMOS memory as an auxiliary source of power when the main power is shut off.

Safety Measures

- There exists explosion hazard if the battery is incorrectly installed.
- Replace only with the same or equivalent type recommended by the manufacturer.
- Dispose of used batteries according to local ordinances.

Internal I/O Connectors

eDP

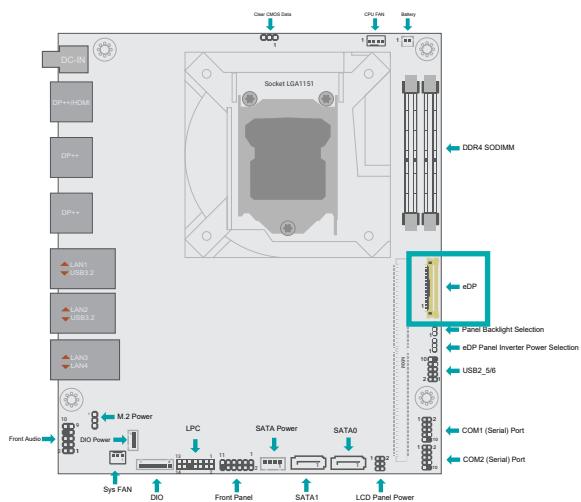

eDP Pin Assignment

Pin	Assignment	Pin	Assignment
1	N.C.	21	eDP_PANEL_PWR
2	VCC_INV_PWR	22	eDP_PANEL_PWR
3	VCC_INV_PWR	23	eDP_PANEL_PWR
4	VCC_INV_PWR	24	GND
5	VCC_INV_PWR	25	eDP_AUXN_C
6	N.C.	26	eDP_AUXP_C
7	N.C.	27	GND
8	DIMMING	28	eDP_LANE0_P
9	BLONOFF	29	eDP_LANE0_N
10	GND	30	GND
11	GND	31	eDP_LANE1_P
12	GND	32	eDP_LANE1_N
13	GND	33	GND
14	eDP_HPD_C	34	eDP_LANE2_P
15	GND	35	eDP_LANE2_N
16	GND	36	GND
17	GND	37	eDP_LANE3_P
18	GND	38	eDP_LANE3_N
19	N.C.	39	GND
20	eDP_PANEL_PWR	40	N.C.

The eDP connector is an embedded displayport which has advanced power-saving features to connect a display device to transmit digital communication of audio and video signals.

The table on the right indicates the pin functions of the eDP connector.

Internal I/O Connectors

USB2_5/6

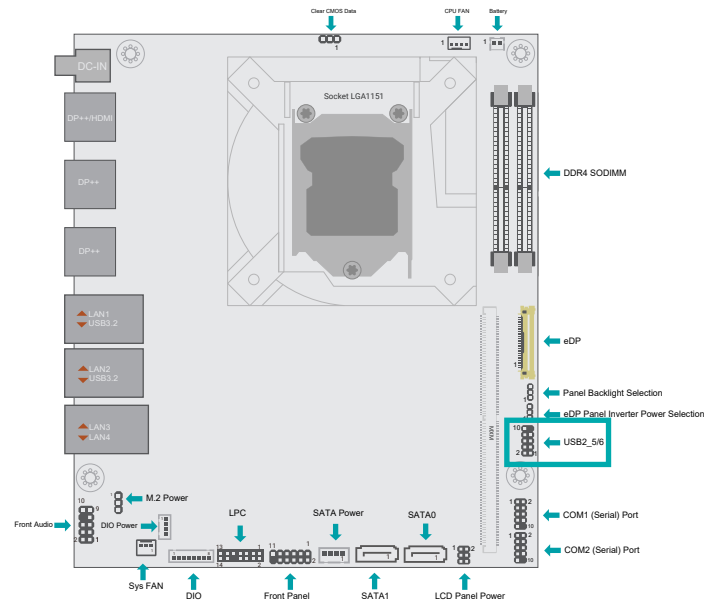

■ USB2_5/6 Pin Assignment

Pin	Assignment	Pin	Assignment
1	SBV4	2	SBV4
3	USBP_C_5N	4	USBP_C_6N
5	USBP_C_5P	6	USBP_C_6P
7	GND	8	GND
9	--	10	N.C

The USB device allows data exchange between your computer and a wide range of simultaneously accessible external Plug and Play peripherals.

The system board is equipped with four onboard USB 3.2 ports at the rear panel I/O ports. The 10-pin connectors allow you to connect 2 additional USB 2.0 ports.

The additional USB ports may be mounted on a card-edge bracket. Install the card-edge bracket to an available slot at the rear of the system chassis and then insert the USB port cables to a connector.

► Internal I/O Connectors

COM (Serial) Port

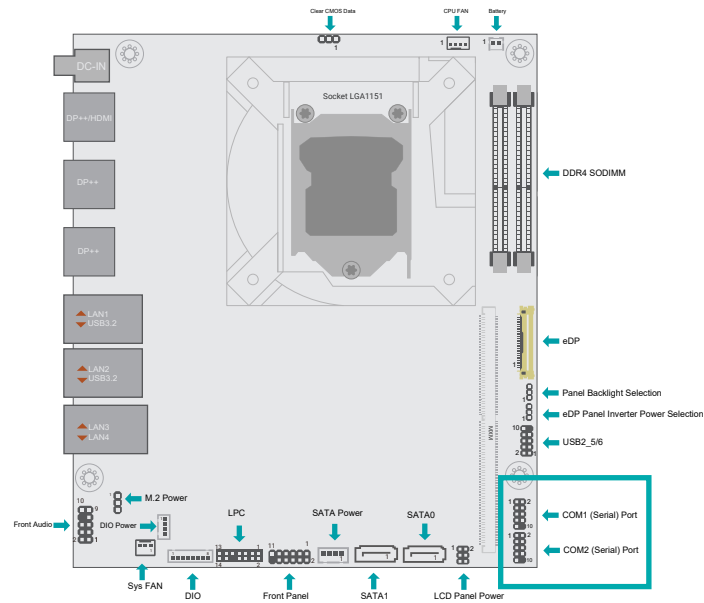

■ COM Port Pin Assignment

Pin	RS232	RS422 Full Duplex	RS485
1	DCD-	TX-	Data-
2	RD	TX+	Data+
3	TD	RX+	N.C
4	DTR-	RX-	N.C
5	GND	GND	GND
6	DSR-	N.C	N.C
7	RTS-	N.C	N.C
8	CTS-	N.C	N.C
9	RI-	N.C	N.C
10	N.C	N.C	N.C

The serial ports are asynchronous communication ports with 16C550A-compatible UARTs that can be used with modems, serial printers, remote display terminals, and other serial devices.

The serial mode of COM 1 and COM 2 can be configured to RS232, RS422 and RS485 via BIOS.

► Internal I/O Connectors

SATA (Serial ATA) and SATA Power

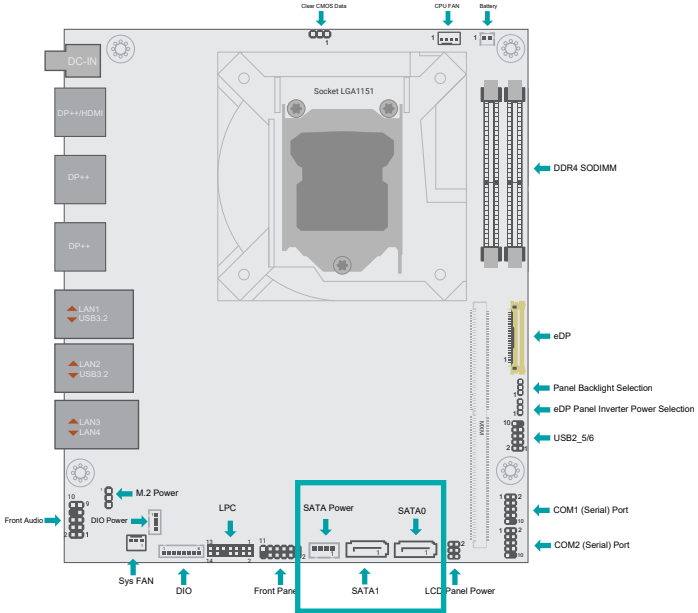

■ SATA Pin Assignment

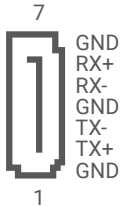

■ SATA Power Pin Assignment



The Serial ATA (SATA) connector is used to connect the Serial ATA device. The system board support one SATA port and provides data rate up to 6Gb/s. Connect one end of the Serial ATA cable to a SATA connector and the other end to your Serial ATA device.

► Internal I/O Connectors

Front Panel

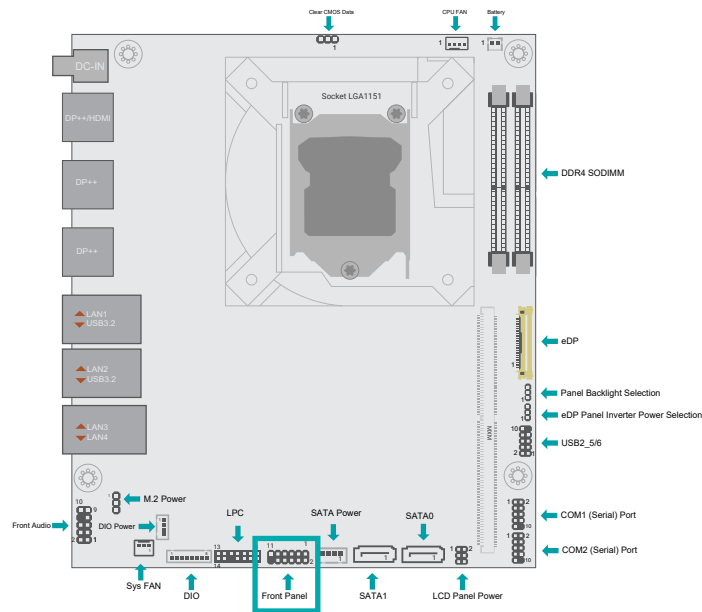

Function	Pin	Assignment	Function	Pin	Assignment
HDD LED	1	N.C.	Power / Standby LED	2	V_SUS_LED
	3	3V3		4	V_SUS_LED
	5	HD_LED		6	SUS_LED
RESET BUTTON	7	Ground	Power Button	8	Ground
	9	SYS_RST		10	PWR_BTN-
	11	N.C.		12	---

HDD-LED - Hard Disk Drive LED

Lighting of the LED indicates that the hard drive is being accessed.

System Reset

This switch allows you to reboot without having to power off the system.

Power/Standby LED

When the system's power is on, this LED will light up. When the system is in the S1 (POS - Power On Suspend) state, it will blink at 1-second intervals. When the system is in the S3 (STR - Suspend To RAM) state, it will blink at 4-second intervals.

Power Switch

This switch is used to power on or off the system.

Internal I/O Connectors

LPC

The LPC connector is used for debugging.

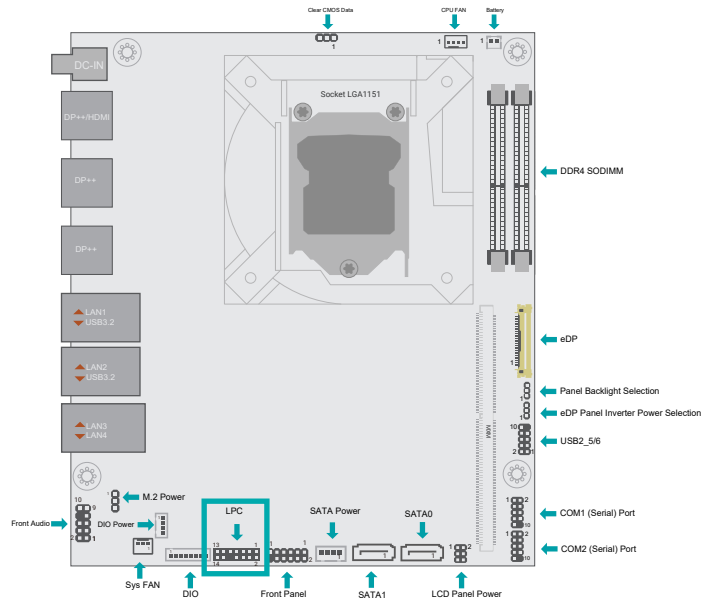

LPC Pin Assignment

Pin	Assignment	Pin	Assignment
1	CLK	2	LAD1
3	RST#	4	LAD0
5	FRAME#	6	VCC3
7	LAD3	8	GND1
9	LAD2	10	---
11	SERIRQ	12	GND2
13	5VSB	14	5V

Internal I/O Connectors

Digital I/O

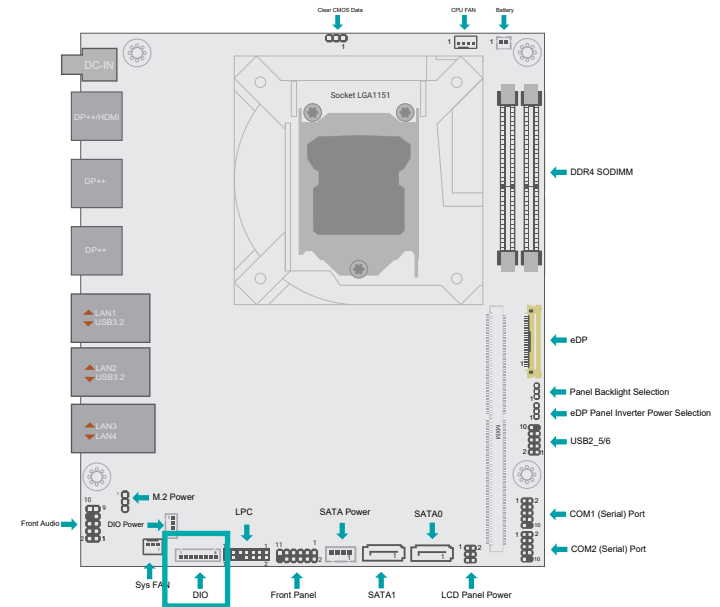

The 8-bit Digital I/O (DIO) connector allows for input/output signals of digital logical states defined by voltage levels.

Digital I/O Pin Assignment

Pin	Assignment	Pin	Assignment
1	D_IOA0_C	2	D_IOA1_C
3	D_IOA2_C	4	D_IOA3_C
5	D_IOA4_C	6	D_IOA5_C
7	D_IOA6_C	8	D_IOA7_C

Internal I/O Connectors

DIO Power

The 4pin DIO Power determines the power output of DIO.

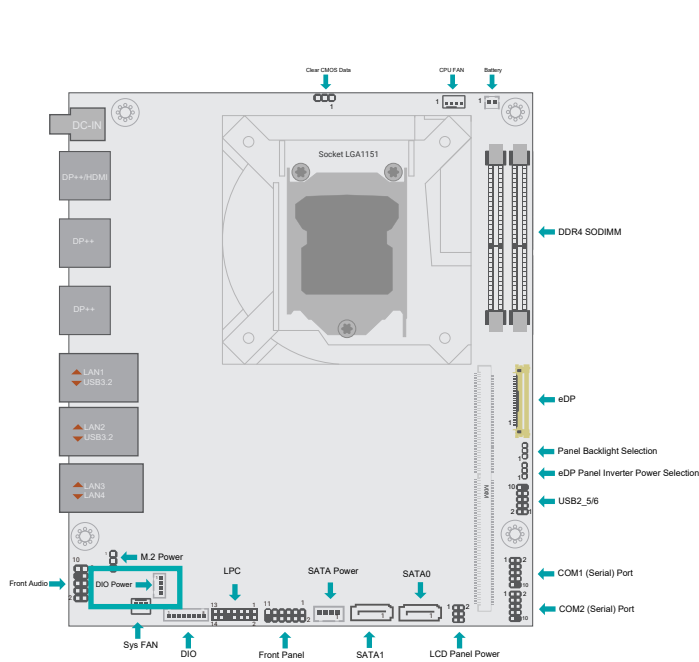

Pin Assignment

1	+12V
2	GND
3	5VSB
4	5V

Internal I/O Connectors

Front Audio

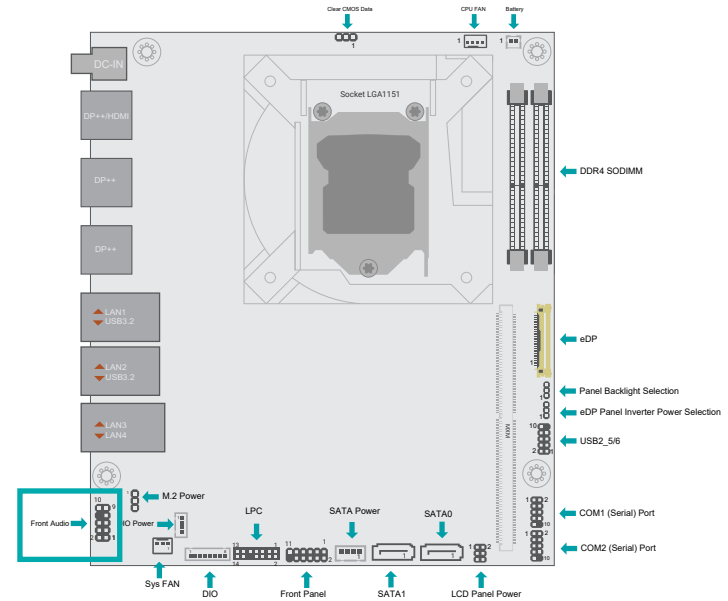

The Front Audio internal connector allows you to connect to the second line-out and mic-in jacks that are at the front panel of your system.

Front Audio Pin Assignment

Pin	Assignment	Pin	Assignment
1	Mic2-L	2	GND
3	Mic2-R	4	N.C.
5	Line2-R	6	Mic2-JD
7	GND	8	--
9	Line2-L	10	Line2-JD

Installing the M.2 Module

Before installing the M.2 module into the M.2 socket, please make sure that the following safety cautions are well-attended.

1. Make sure the PC and all other peripheral devices connected to it has been powered down.
2. Disconnect all power cords and cables.
3. Locate the M.2 socket on the system board
4. Make sure the notch on card is aligned to the key on the socket.
5. Make sure the standoff screw is removed from the standoff.

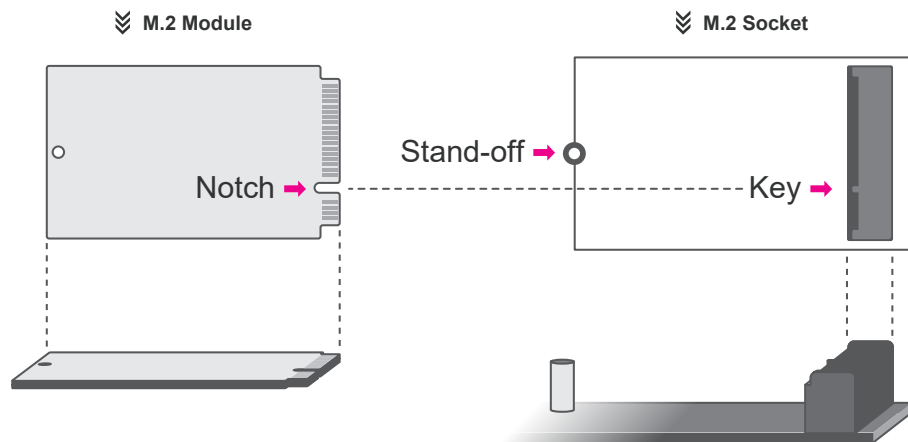

Please follow the steps below to install the card into the socket.

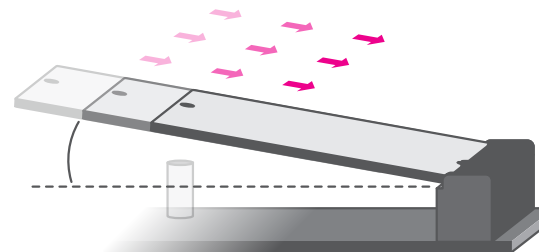

Step 1:
Insert the card into the socket at an angle while making sure the notch and key are perfectly aligned.



Step 2:
Press the end of the card far from the socket down until against the stand-off.

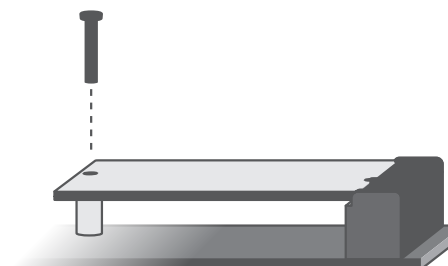

Step 3:
Screw tight the card onto the stand-off with a screw driver and a stand-off screw until the gap between the card and the stand-off closes up. The card should be lying parallel to the board when it's correctly mounted.

Installing the Mini PCIe Module

Before installing the Mini PCIe module into the Mini PCIe socket, please make sure that the following safety cautions are well-attended.

1. Make sure the PC and all other peripheral devices connected to it has been powered down.
2. Disconnect all power cords and cables.
3. Locate the Mini PCIe socket on the system board
4. Make sure the notch on card is aligned to the key on the socket.

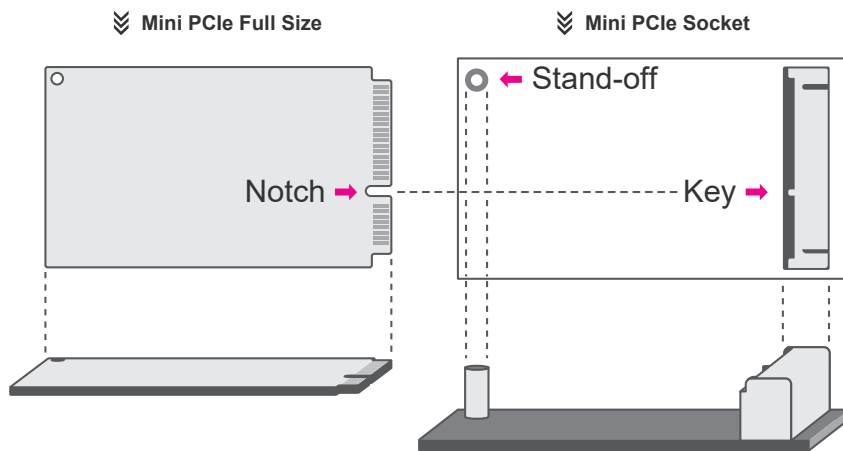

Please follow the steps below to install the card into the socket.

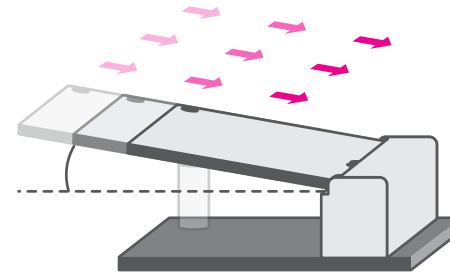

Step 1:

Insert the card into the socket at an angle while making sure the notch and key are perfectly aligned.

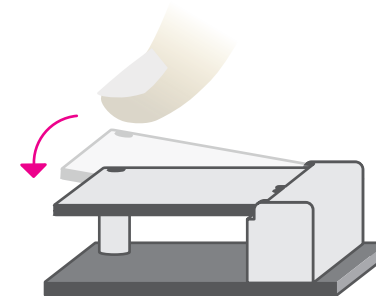

Step 2:

Press the end of the card far from the socket down until against the stand-off.

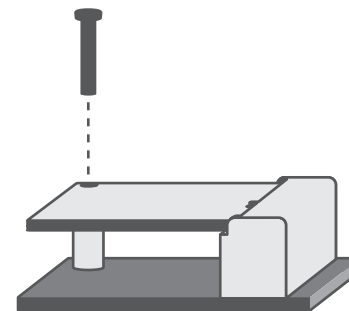

Step 3:

Screw tight the card onto the stand-off with a screw driver and a stand-off screw until the gap between the card and the stand-off closes up. The card should be lying parallel to the board when it's correctly mounted.

Chapter 3 - BIOS Settings

► Overview

The BIOS is a program that takes care of the basic level of communication between the CPU and peripherals. It contains codes for various advanced features found in this system board.

The BIOS allows you to configure the system and save the configuration in a battery-backed CMOS so that the data retains even when the power is off. In general, the information stored in the CMOS RAM of the EEPROM will stay unchanged unless a configuration change has been made such as a hard drive replaced or a device added. It is possible that the CMOS battery will fail causing CMOS data loss. If this happens, you need to install a new CMOS battery and reconfigure the BIOS settings.



Note:

The BIOS is constantly updated to improve the performance of the system board; therefore the BIOS screens in this chapter may not appear the same as the actual one. These screens are for reference purpose only.

Default Configuration

Most of the configuration settings are either predefined according to the Load Optimal Defaults settings which are stored in the BIOS or are automatically detected and configured without requiring any actions. There are a few settings that you may need to change depending on your system configuration.

Entering the BIOS Setup Utility

The BIOS Setup Utility can only be operated from the keyboard and all commands are keyboard commands. The commands are available at the right side of each setup screen.

The BIOS Setup Utility does not require an operating system to run. After you power up the system, the BIOS message appears on the screen and the memory count begins. After the memory test, the message "Press DEL to run setup" will appear on the screen. If the message disappears before you respond, restart the system or press the "Reset" button. You may also restart the system by pressing the <Ctrl> <Alt> and keys simultaneously.

Legends

Keys	Function
Right / Left arrow	Move the highlight left or right to select a menu
Up / Down arrow	Move the highlight up or down between submenus or fields
<Enter>	Enter the highlighted submenu
+ (plus key)/F6	Scroll forward through the values or options of the highlighted field
- (minus key)/F5	Scroll backward through the values or options of the highlighted field
<F1>	Display general help
<F2>	Display previous values
<F9>	Optimized defaults
<F10>	Save and Exit
<Esc>	Return to previous menu

Scroll Bar

When a scroll bar appears to the right of the setup screen, it indicates that there are more available fields not shown on the screen. Use the up and down arrow keys to scroll through all the available fields.

Submenu

When "►" appears on the left of a particular field, it indicates that a submenu which contains additional options are available for that field. To display the submenu, move the highlight to that field and press <Enter>.

► Main

The Main menu is the first screen that you will see when you enter the BIOS Setup Utility.

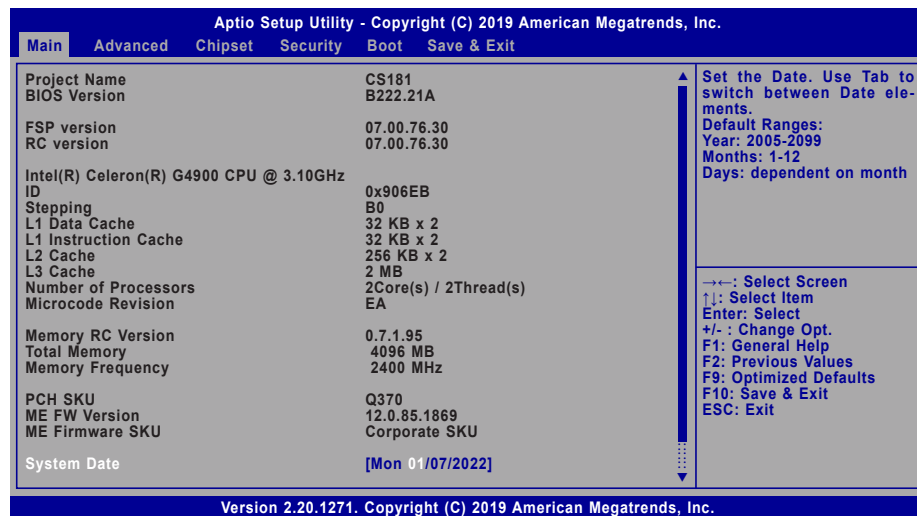

System Date

The date format is <month>, <date>, <year>. Press "Tab" to switch to the next field and press "-" or "+" to modify the value.

System Time

The time format is <hour>, <minute>, <second>. The time is based on the 24-hour military-time clock. For example, 1 p.m. is 13:00:00. Hour displays hours from 00 to 23. Minute displays minutes from 00 to 59. Second displays seconds from 00 to 59.

► Advanced

The Advanced menu allows you to configure your system for basic operation. Some entries are defaults required by the system board, while others, if enabled, will improve the performance of your system or let you set some features according to your preference.



Important:
Setting incorrect field values may cause the system to malfunction.

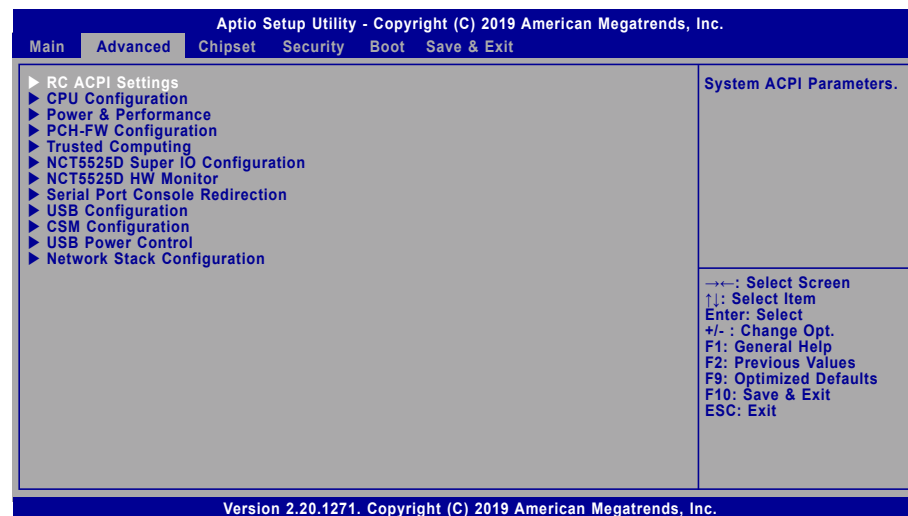

▶ Advanced

RC ACPI Configuration

Aptio Setup Utility - Copyright (C) 2019 American Megatrends, Inc.		
Advanced		
RC ACPI Configuration		Enable or disable System wake on alarm event. When enabled, System will wake on the hr:min::sec specified
Wake system from S5 via RTC	[Enabled]	
Wake up hour	0	→←: Select Screen ↑↓: Select Item Enter: Select +/-: Change Opt. F1: General Help F2: Previous Values F9: Optimized Defaults F10: Save & Exit ESC: Exit
Wake up minute	0	
Wake up second	0	
State After G3	[S0 State]	
Version 2.20.1271. Copyright (C) 2019 American Megatrends, Inc.		

Wake system from S5

When Enabled, the system will automatically power up at a designated time every day. Once it's switched to [Enabled], please set up the time of day — hour, minute, and second — for the system to wake up.

State After G3

When Enabled, the system will automatically power up at a designated time every day. Once it's switched to [Enabled], please set up the time of day — hour, minute, and second — for the system to wake up.

▶ Advanced

CPU Configuration

Aptio Setup Utility - Copyright (C) 2019 American Megatrends, Inc.		
Advanced		
CPU Configuration		When enabled, a VMM can utilize the additional hardware capabilities provided by Vanderpool Technology.
Intel (VMX) Virtualization Technology	[Enable]	
Active Processor Cores	[All]	→←: Select Screen ↑↓: Select Item Enter: Select +/-: Change Opt. F1: General Help F2: Previous Values F9: Optimized Defaults F10: Save & Exit ESC: Exit
Version 2.20.1271. Copyright (C) 2019 American Megatrends, Inc.		

Intel (VMX) Virtualization Technology

When this field is set to Enabled, the VMM can utilize the additional hardware capabilities provided by Vanderpool Technology.

Active Processor Cores

Select number of cores to enable in each processor package: all or 1.



Note:
Some of the fields may not be available when the features are not supported by the equipped CPU.

▶ Advanced

Power & Performance

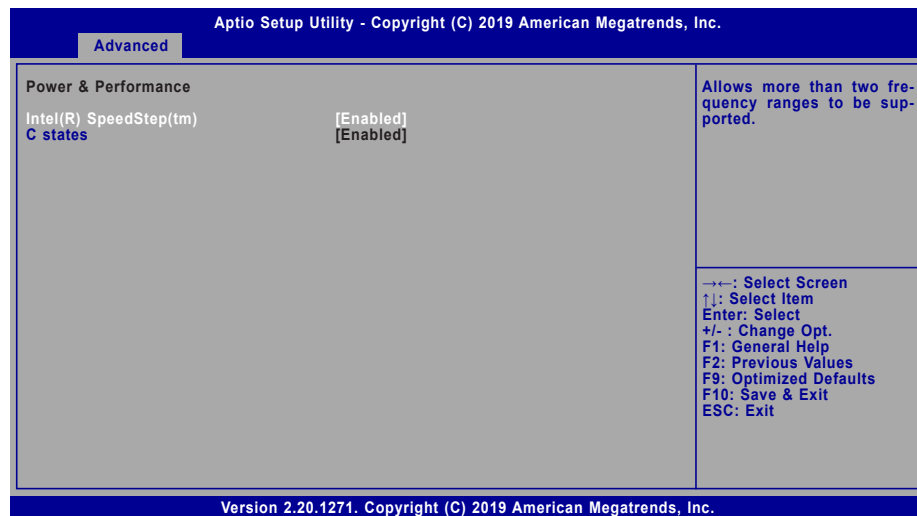

Intel(R) SpeedStep(tm)

This field is used to enable or disable the Intel SpeedStep® Technology, which helps optimize the balance between system's power consumption and performance. After it is enabled in the BIOS, EIST features can then be enabled via the operating system's power management.

C states

Enable or disable CPU Power Management. It allows CPU to enter "C states" when it's idle and nothing is executing.

▶ Advanced

PCH-FW Configuration

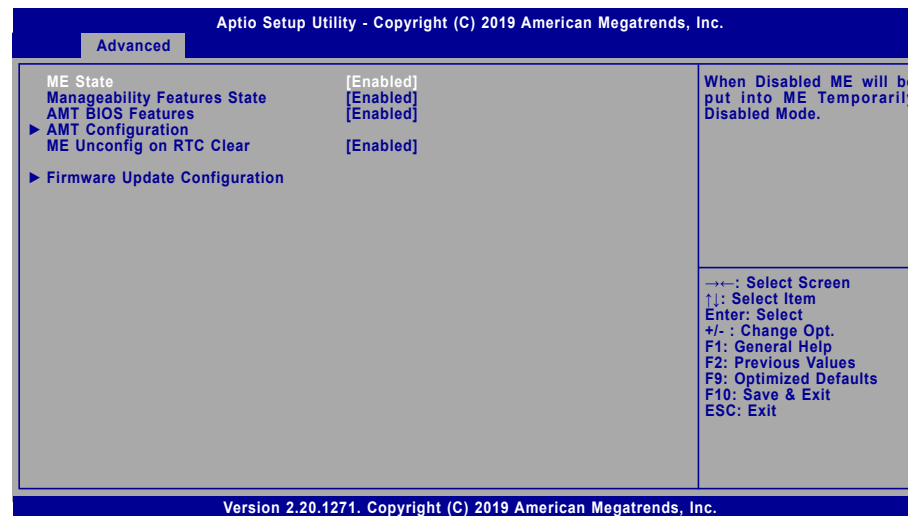

ME State

When this field is set to Disabled, ME will be put into ME Temporarily Disabled Mode.

Manageability Features State

Enable or disable Intel(R) Manageability features. This option disables/enables Manageability Features support in FW. To disable, support platform must be in an unprovisioned state first.

AMT BIOS Features

When disabled, AMT BIOS features are no longer supported and user is no longer able to access MEBx Setup. This option does not disable manageability features in FW.

ME Unconfig on RTC Clear

When disabled, ME will not be unconfigured on RTC Clear.

Note:
The sub-menus are detailed in following sections.

▶ Advanced ▶ PCH-FW Configuration

▶ AMT Configuration

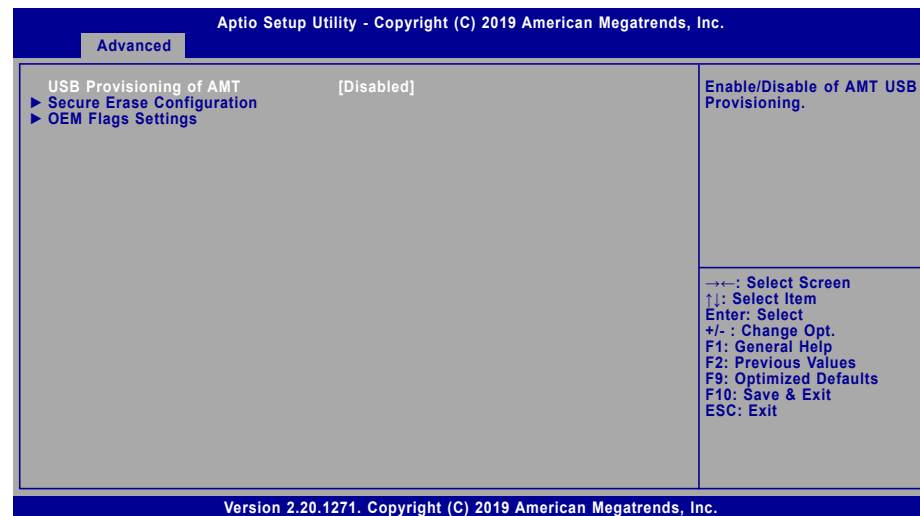

USB Provisioning of AMT

Enable or disable AMT USB Provisioning.

▶ Advanced ▶ PCH-FW Configuration

▶ AMT Configuration ▶ Secure Erase Configuration

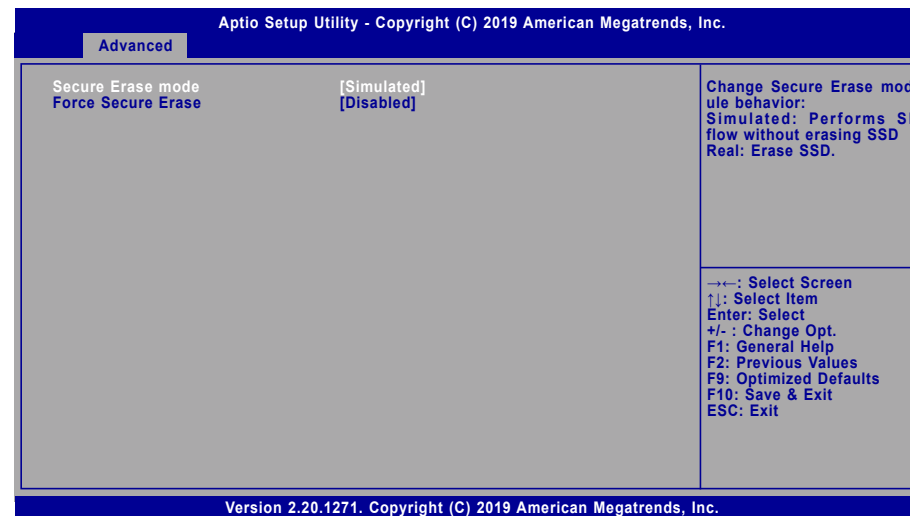

Secure Erase Mode

Select Secure Erase module behavior: Simulated or Real.

Force Secure Erase

Enable or disable Force Secure Erase on next boot.

▶ Advanced ▶ PCH-FW Configuration

▶ AMT Configuration ▶ OEM Flags Settings

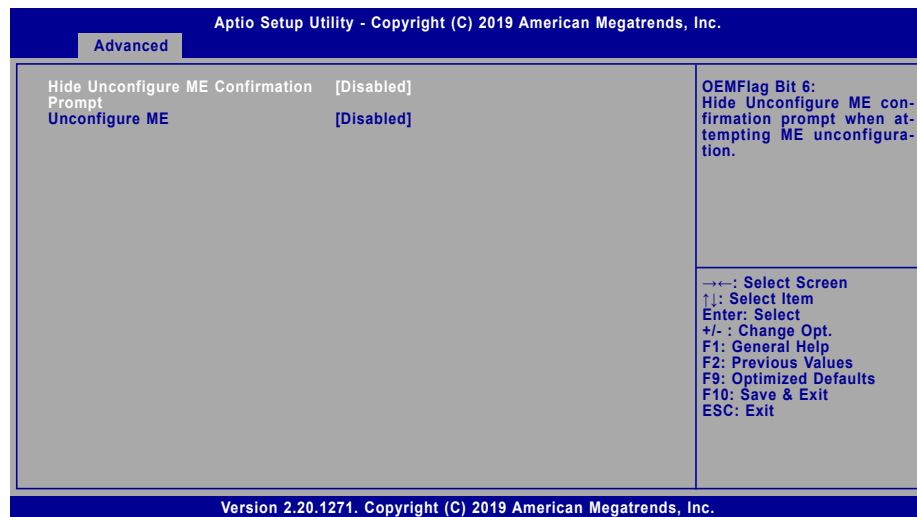

Hide Unconfigure ME Confirmation Prompt

Enable or disable to hide unconfigure ME confirmation prompt when attempting ME unconfiguration.

Unconfigure ME

Enable or disable to unconfigure ME with resetting MEBx password to default.

▶ Advanced ▶ PCH-FW Configuration

▶ Firmware Update Configuration

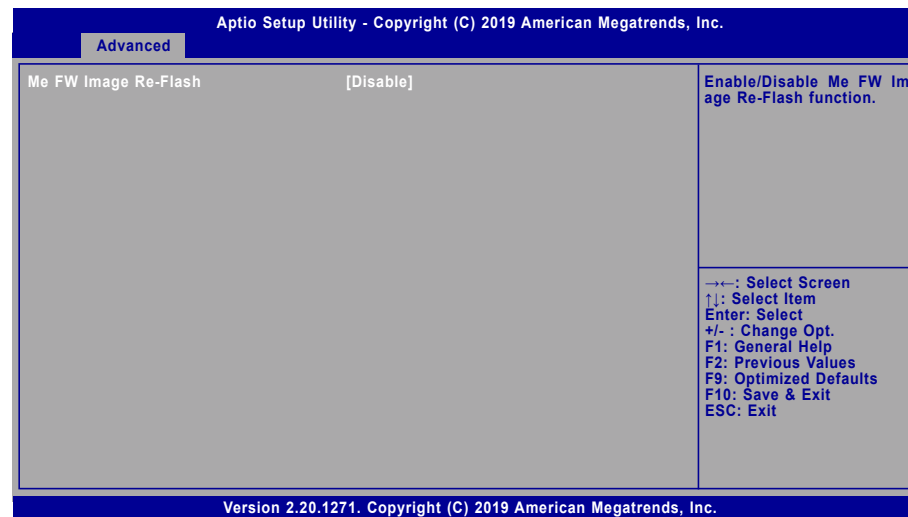

Me FW Image Re-Flash

This field is used to enable or disable the ME FW Image Re-Flash function, which allows the user to update the ME firmware.

▶ Advanced

Trusted Computing

Aptio Setup Utility - Copyright (C) 2019 American Megatrends, Inc.		
Advanced		
TPM20 Device Found	7.2	Enables or Disables BIOS support for security device. O.S will not show Security Device. TCG EFI protocol and INT1A interface will not be available.
Firmware Version	NTC	
Security Device Support	[Enable]	
Pending operation	[None]	
		→←: Select Screen ↑↓: Select Item Enter: Select +/- : Change Opt. F1: General Help F2: Previous Values F9: Optimized Defaults F10: Save & Exit ESC: Exit
Version 2.20.1271. Copyright (C) 2019 American Megatrends, Inc.		

Security Device Support

This field is used to enable or disable BIOS support for the security device such as an TPM 2.0 to achieve hardware-level security via cryptographic keys.

Pending operation

To clear the existing TPM encryption, select "TPM Clear" and restart the system. This field is not available when "Security Device Support" is disabled.

▶ Advanced

NCT5525D Super IO Configuration

Aptio Setup Utility - Copyright (C) 2019 American Megatrends, Inc.	
Advanced	
NCT5525D Super IO Configuration	
Super IO Chip	NCT5525D
WatchDog Timer Unit	[Second]
SuperIO WatchDog Timer	0
<ul style="list-style-type: none"> ▶ Serial Port 1 Configuration ▶ Serial Port 2 Configuration 	
→←: Select Screen ↑↓: Select Item Enter: Select +/- : Change Opt. F1: General Help F2: Previous Values F9: Optimized Defaults F10: Save & Exit ESC: Exit	
Version 2.20.1271. Copyright (C) 2019 American Megatrends, Inc.	

WatchDog Timer Unit

Select WatchDog Timer Unit – Second or Minute.

SuperIO WatchDog Timer

Set SuperIO WatchDog Timer Timeout value. The range is from 0 (disabled) to 255.



Note:

The sub-menus are detailed in following sections.

▶ Advanced ▶ NCT5525D Super IO Configuration

▶ Serial Port Configuration

Aptio Setup Utility - Copyright (C) 2019 American Megatrends, Inc.	
Advanced	
Serial Port 1 Configuration	
Serial Port	[Enabled]
Device Settings	IO=3F8h; IRQ=4;
Electrical Interface Mode	[RS232]
Enable or Disable Serial Port (COM)	
→←: Select Screen ↑↓: Select Item Enter: Select +/- : Change Opt. F1: General Help F2: Previous Values F9: Optimized Defaults F10: Save & Exit ESC: Exit	
Version 2.20.1271. Copyright (C) 2019 American Megatrends, Inc.	

Serial Port

Enable or disable the current serial COM port.

Electrical Interface Mode

Choose mode between RS232 / RS485 / RS422

▶ Advanced

NCT5525D HW Monitor

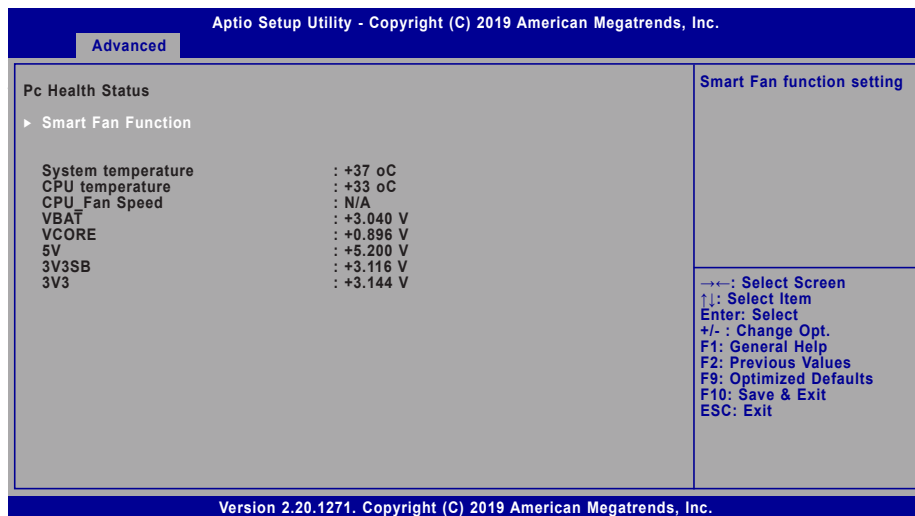

▶ Advanced ▶ NCT5525D HW Monitor

▶ Smart Fan Function

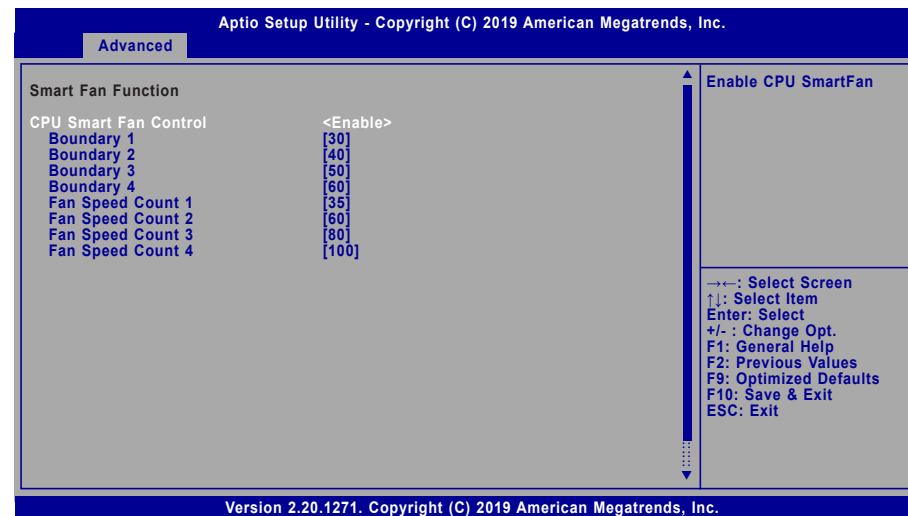

Smart Fan is a fan speed moderation strategy dependent on the current system temperature. When the system temperature goes higher than the Boundary setting, the fan speed will be turned up to the setting of the Fan Speed Count that bears the same index as the Boundary field.

▼ CPU Smart Fan Control = [Enabled]

Boundary 1 to Boundary 4

Set the boundary temperatures that determine the fan speeds accordingly, the value ranging from 0-127°. For example, when the system temperature reaches Boundary 1 setting, the fan speed will be turned up to the designated speed of the Fan Speed Count 1 field.

Fan Speed Count 1 to Fan Speed Count 4

Set the fan speed, the value ranging from 1-100%, 100% being full speed. The fans will operate according to the specified boundary temperatures above-mentioned.

▼ SYS Smart Fan/CPU Smart Fan Control = [Disabled]

Fix Fan Speed Count

Set the fan speed, the value ranging from 1-100%, 100% being full speed. The fans will always operate at the specified speed regardless of gauged temperatures.

▶ Smart Fan Function

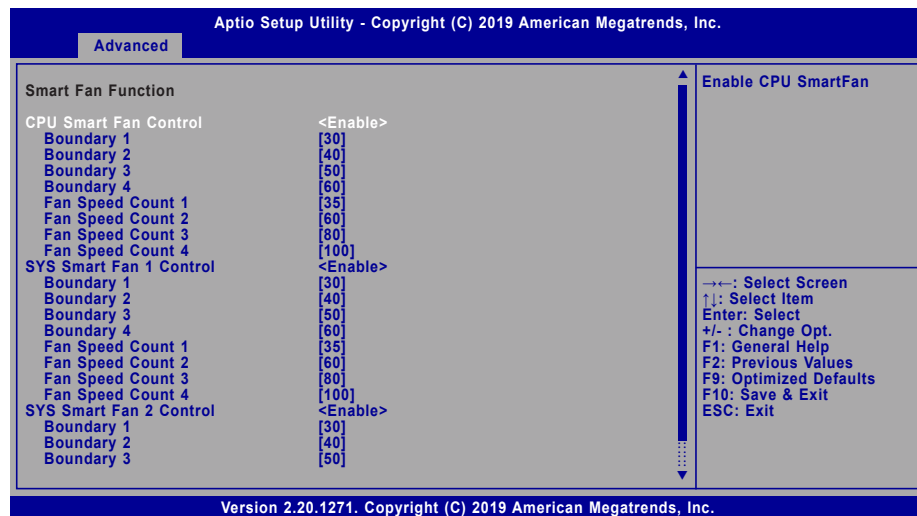

Smart Fan is a fan speed moderation strategy dependent on the current system temperature. When the system temperature goes higher than the Boundary setting, the fan speed will be turned up to the setting of the Fan Speed Count that bears the same index as the Boundary field.

▼ **SYS Smart Fan/CPU Smart Fan Control = [Enabled]**

Boundary 1 to Boundary 4

Set the boundary temperatures that determine the fan speeds accordingly, the value ranging from 0-127°. For example, when the system temperature reaches Boundary 1 setting, the fan speed will be turned up to the designated speed of the Fan Speed Count 1 field.

Fan Speed Count 1 to Fan Speed Count 4

Set the fan speed, the value ranging from 1-100%, 100% being full speed. The fans will operate according to the specified boundary temperatures above-mentioned.

▼ **SYS Smart Fan/CPU Smart Fan Control = [Disabled]**

Fix Fan Speed Count

Set the fan speed, the value ranging from 1-100%, 100% being full speed. The fans will always operate at the specified speed regardless of gauged temperatures.

Serial Port Console Redirection

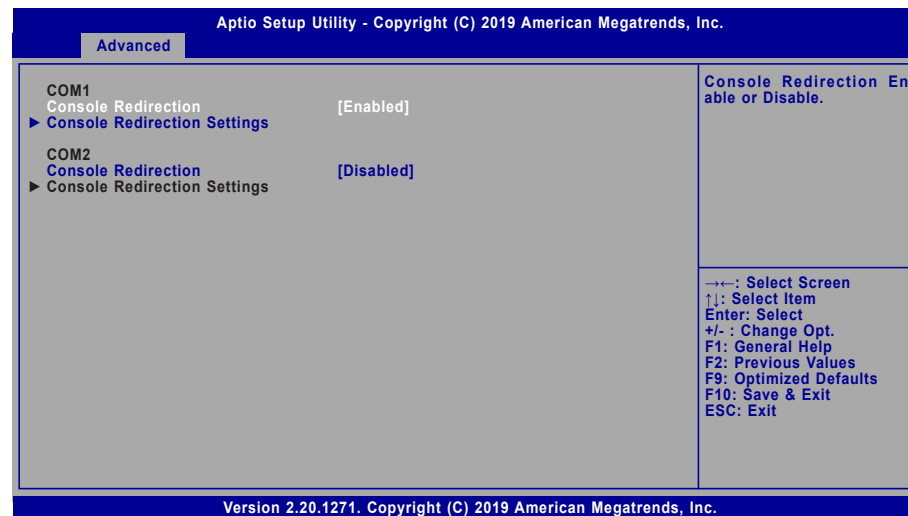

Console Redirection

By enabling Console Redirection of a COM port, the sub-menu of console redirection settings will become available for configuration as detailed in the following.

▶ Console Redirection Settings

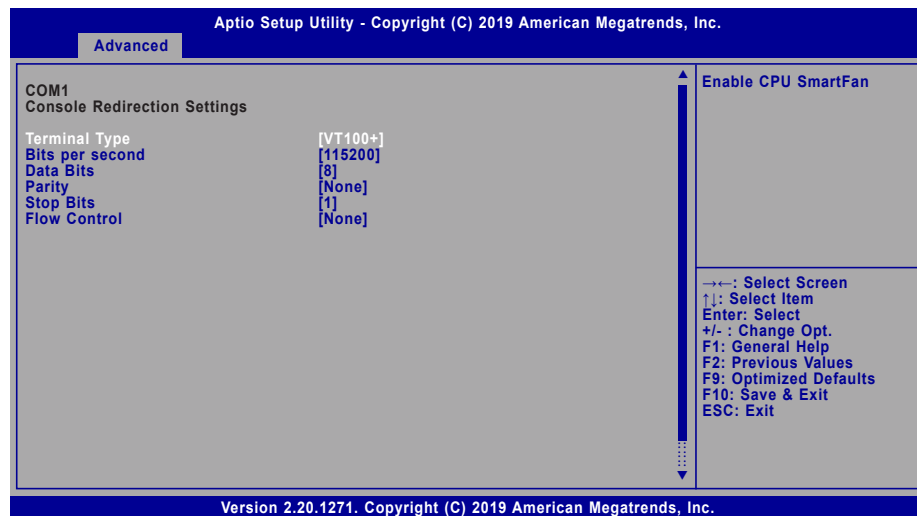

Configure the serial settings of the current COM port.

Terminal Type

Select terminal type: VT100, VT100+, VT-UTF8 or ANSI.

Bits per second

Select serial port transmission speed: 9600, 19200, 38400, 57600 or 115200.

Data Bits

Select data bits: 7 bits or 8 bits.

Parity

Select parity bits: None, Even, Odd, Mark or Space.

Stop Bits

Select stop bits: 1 bit or 2 bits.

Flow Control

Select flow control type: None or Hardware RTS/CTS.

USB Configuration

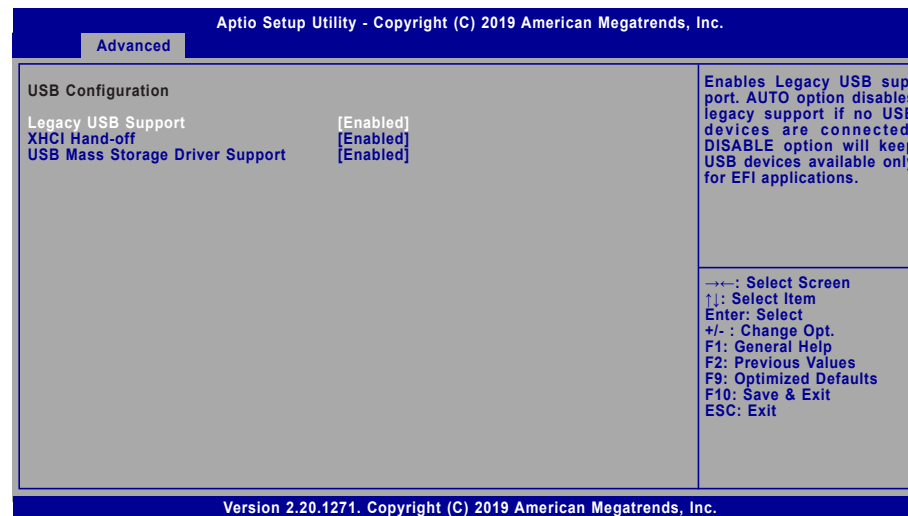

Legacy USB Support

- Enabled** Enable Legacy USB support.
- Disabled** Keep USB devices available only for EFI applications.
- Auto** Disable Legacy support if no USB devices are connected.

XHCI Hand-off

Enable or disable XHCI Hand-off.

USB Mass Storage Driver Support

Enable or disable USB Mass Storage Driver Support.

► Advanced

Network Stack Configuration

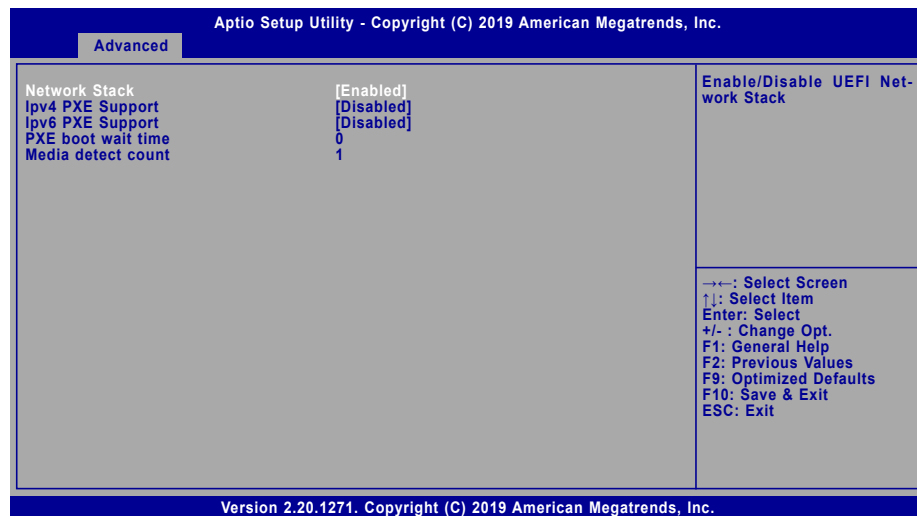

Network Stack

Enable or disable UEFI network stack. The following fields will appear when this field is enabled.

Ipv4 PXE Support

Enable or disable IPv4 PXE boot support. If disabled, IPv4 PXE boot support will not be available.

Ipv6 PXE Support

Enable or disable IPv6 PXE boot support. If disabled, IPv6 PXE boot support will not be available.

PXE boot wait time

Set the wait time in seconds to press ESC key to abort the PXE boot. Use either +/- or numeric keys to set the value.

Media detect count

Set the number of times the presence of media will be checked. Use either +/- or numeric keys to set the value.

► Advanced

CSM Configuration

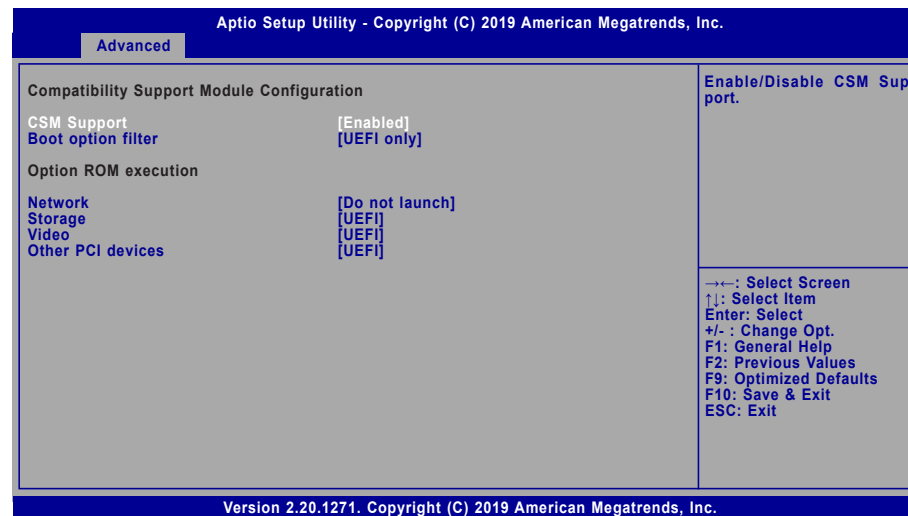

CSM Support

This section is used to enable or disable CSM Support. The following fields are only available when "CSM Support" is enabled.

Boot option filter

This field controls Legacy/UEFI ROMs priority.

Network

This field controls the execution of UEFI and Legacy Network OpROM.

Storage

This field controls the execution of UEFI and Legacy Storage OpROM.

Video

This field controls the execution of UEFI and Legacy Video OpROM.

Other PCI devices

This field determines OpROM execution policy for devices other than Network, Storage or Video.

▶ Advanced

USB Power Control

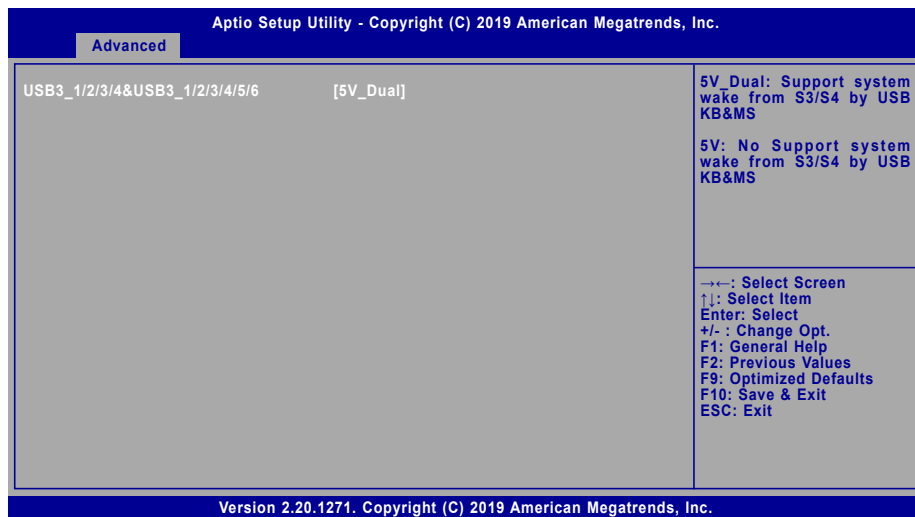

USB Power

5V_Dual: Support system wake from S3/S4 by USB KB&MS

5V: No Support system wake from S3/S4 by USB KB&MS

► Chipset

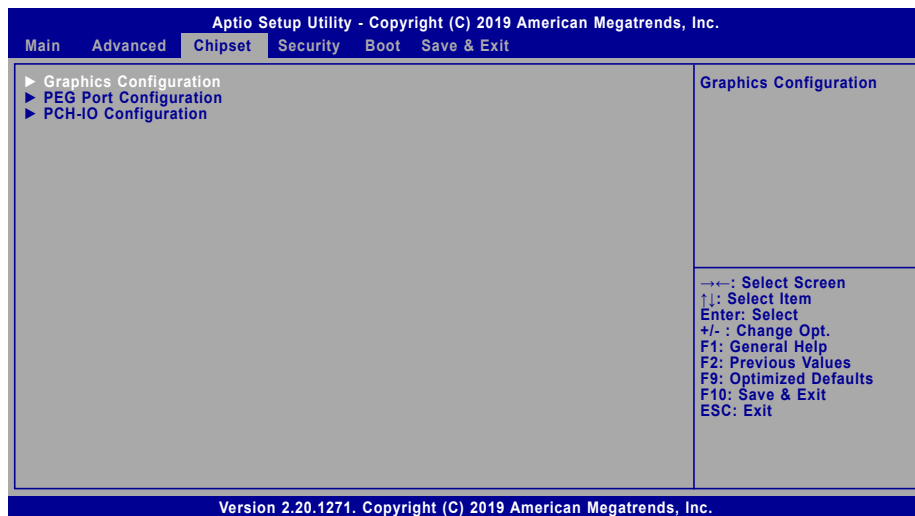

► Chipset

Graphics Configuration

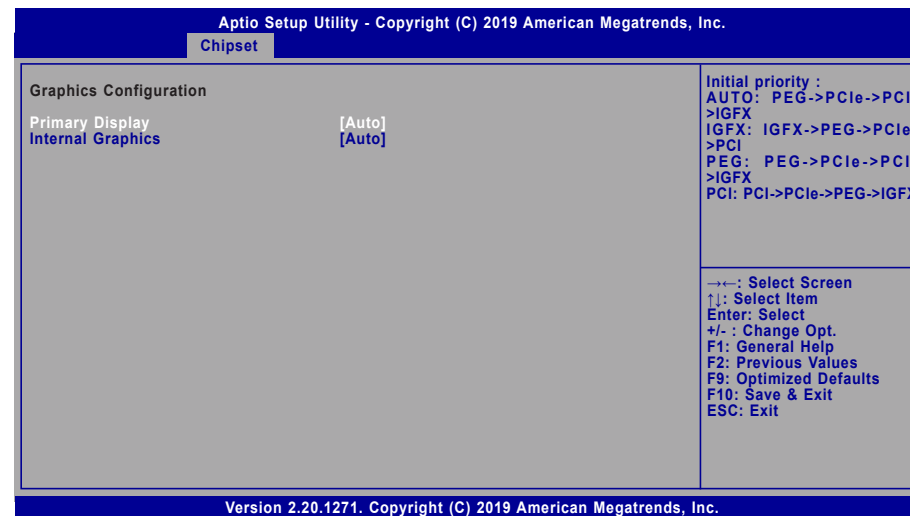

Primary Display

Select which of IGFX/PEG/PCI Graphics device to be the primary display.

Internal Graphics

Keep IGFX enabled based on the setup options.

► Chipset

PEG Port Configuration

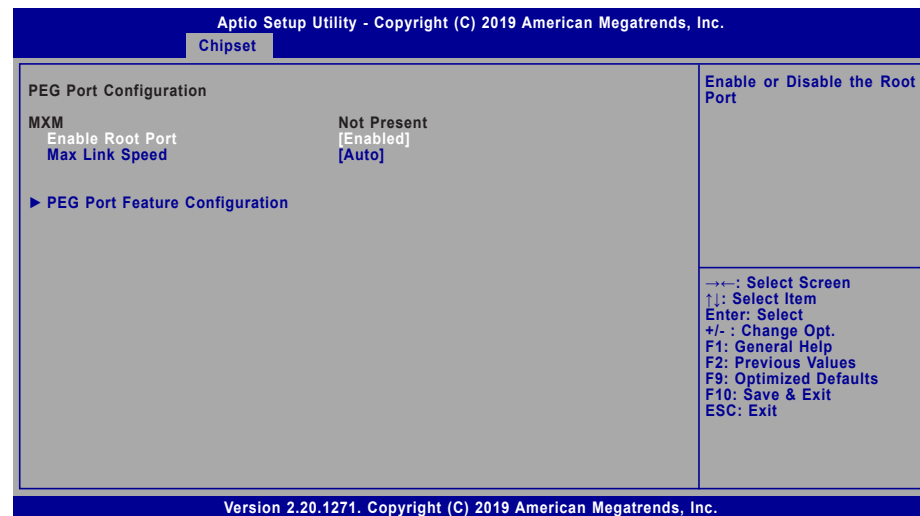

Enable Root Port

Enable or disable the root port, or select "Auto" for auto-detection.

Max Link Speed

Configure PCIE1/PCIE3 port's Max Speed: Auto, Gen1, Gen2 or Gen3.

► PEG Port Feature Configuration

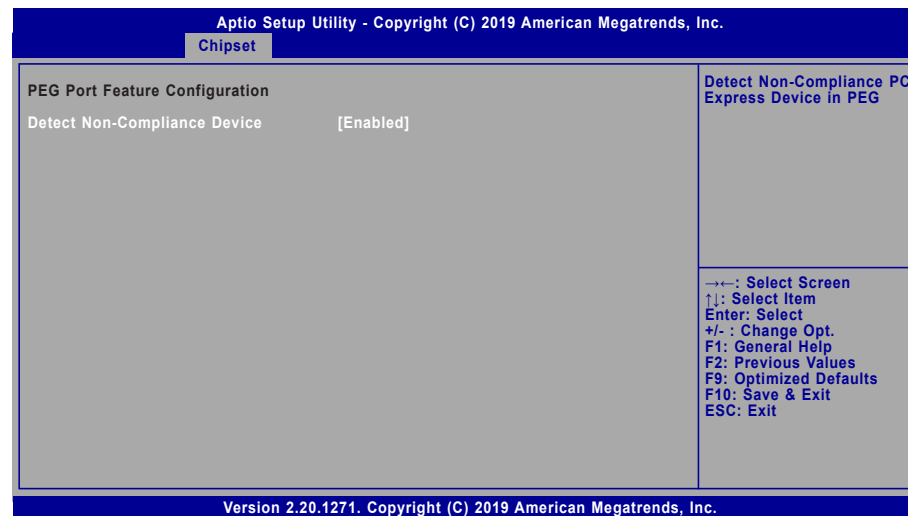



Detect Non-Compliance Device

Enable or disable this field to detect non-compliance PCIe devices in the PEG.

► Chipset

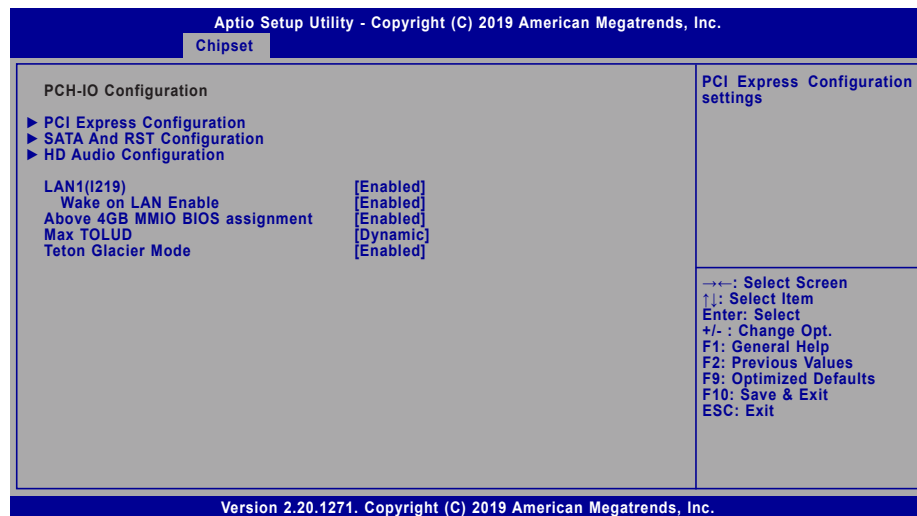
PCH-IO Configuration



 **Note:**
The sub-menus are detailed in following sections.

LAN1(I219)

Enable or disable onboard NIC.

Wake on LAN Enable

Enable or disable integrated LAN to wake the system.

Above 4GB MMIO BIOS assignment

Enable/Disable above 4GB MemoryMappedIO BIOS assignment. This is enabled automatically when Aperture Size is set to 2048MB.

Max TOLUD

Assign the maximum value of Top Of Lower Usable DRAM (TOLUD). Select to specify a fixed value, or select "Dynamic" so that the assignment would adjust TOLUD automatically based on largest MMIO length of installed graphic controller.

Teton Glacier Mode

Switch between Dynamic Configuration for Teton Glacier Enable or Disabled.

► Chipset

PCI Express Configuration

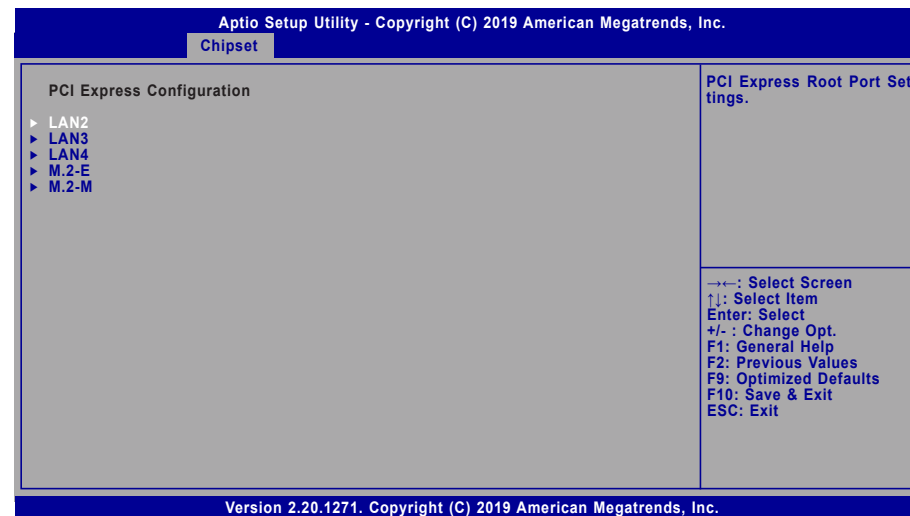

Select one of the PCI Express channels and press enter to configure the following settings.

PCIe Speed

Select PCIe Speed of the current port — AUTO, Gen1, Gen 2, or Gen3. Gen 3 is only available for the PCIe1 port. This field may not appear when the speed of the port is not configurable.

Hot Plug

Enable or disable hot plug function of the port. This field may not appear when the port does not support hot plug.

► Advanced

SATA And RST Configuration

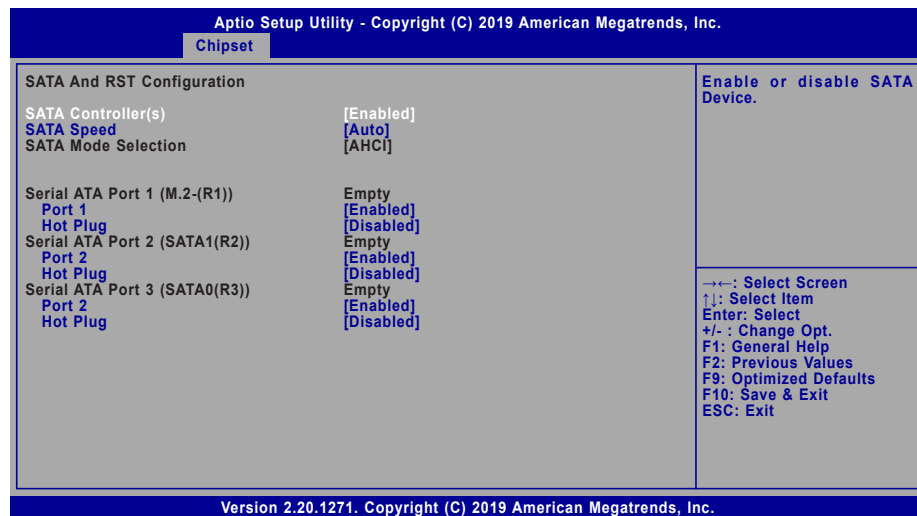

SATA Controller(s)

This field is used to enable or disable the Serial ATA controller.

SATA Speed

This field is used to select SATA speed generation limit: Auto, Gen1, Gen2 or Gen3.

SATA Mode Selection

The mode selection determines how the SATA controller(s) operates.

AHCI This option allows the Serial ATA controller(s) to use AHCI (Advanced Host Controller Interface).

Intel RST Premium With Intel Optane System Acceleration This option allows you to create RAID or Intel Rapid Storage configuration along with Intel® Optane™ system acceleration on Serial ATA devices.

Use RST Legacy OROM

This field shows up when SATA Mode Selection is set to Intel RST Premium With Intel Optane System Acceleration. Enable or disable to use RST Legacy OROM when CSM is enabled.

Port and Hot Plug

Enable or disable the Serial ATA port and its hot plug function.

► Chipset

HD Audio Configuration

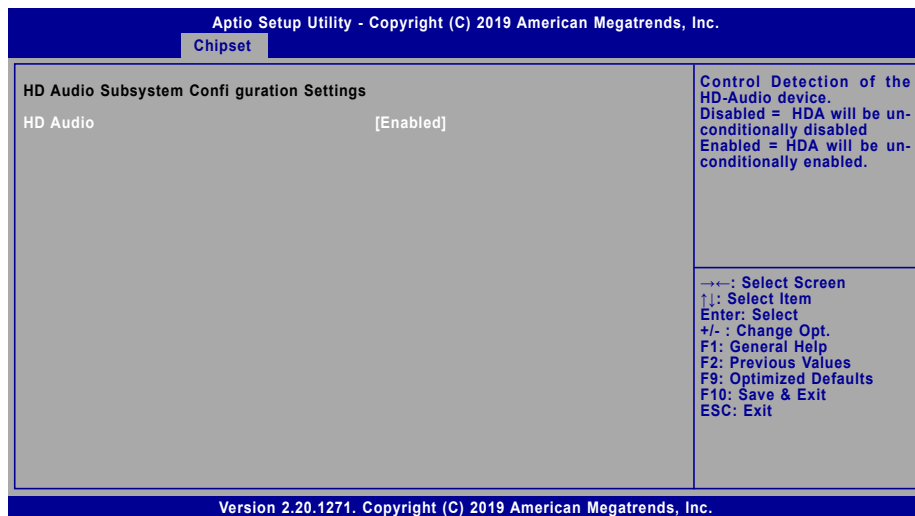

HD Audio

Control the detection of the HD Audio device.

Disabled HDA will be unconditionally disabled.

Enabled HDA will be unconditionally enabled.

► Security

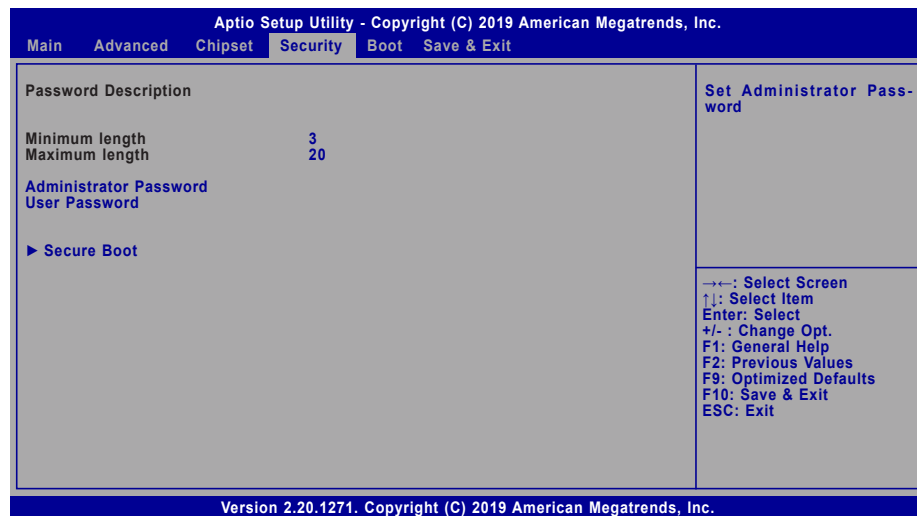

Administrator Password

Set the administrator password. To clear the password, input nothing and press enter when a new password is asked. Administrator Password will be required when entering the BIOS.

User Password

Set the user password. To clear the password, input nothing and press enter when a new password is asked. User Password will be required when powering up the system.

► Security

Secure Boot

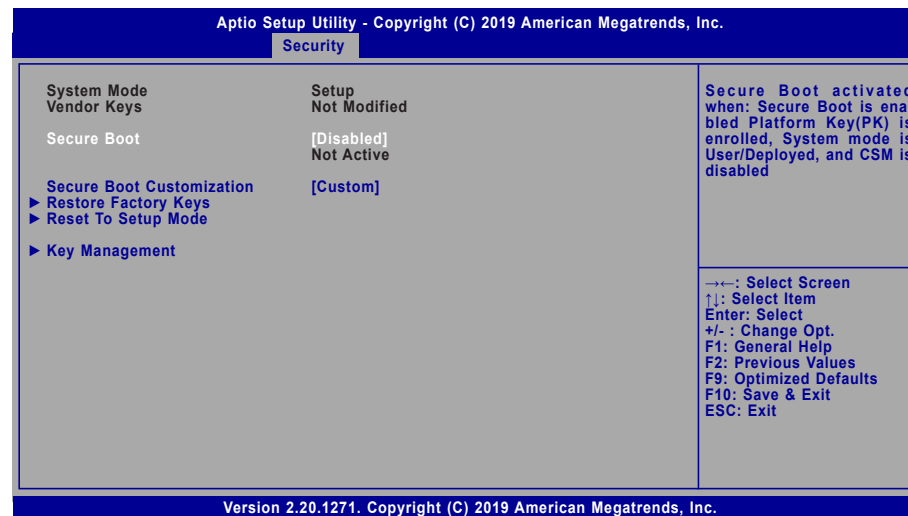

Secure Boot

The Secure Boot store a database of certificates in the firmware and only allows the Oses with authorized signatures to boot on the system. To activate Secure Boot, please make sure that “Secure Boot” is “[Enabled]”, Platform Key (PK) is enrolled, “System Mode” is “User”, and CSM is disabled. After enabling/disabling Secure Boot, please save the configuration and restart the system. When configured and activated correctly, the Secure Boot status will be “Active”.

Secure Boot Customization

Select the secure boot mode – Standard or Custom. When set to Custom, the following fields will be configurable for the user to manually modify the key database.

Restore Factory Keys

Force system to User Mode. Load OEM-defined factory defaults of keys and databases onto the Secure Boot. Press Enter and a prompt will show up for you to confirm.

Reset To Setup Mode

Clear the database from the NVRAM, including all the keys and signatures installed in the Key Management menu. Press Enter and a prompt will show up for you to confirm.

▶ Key Management

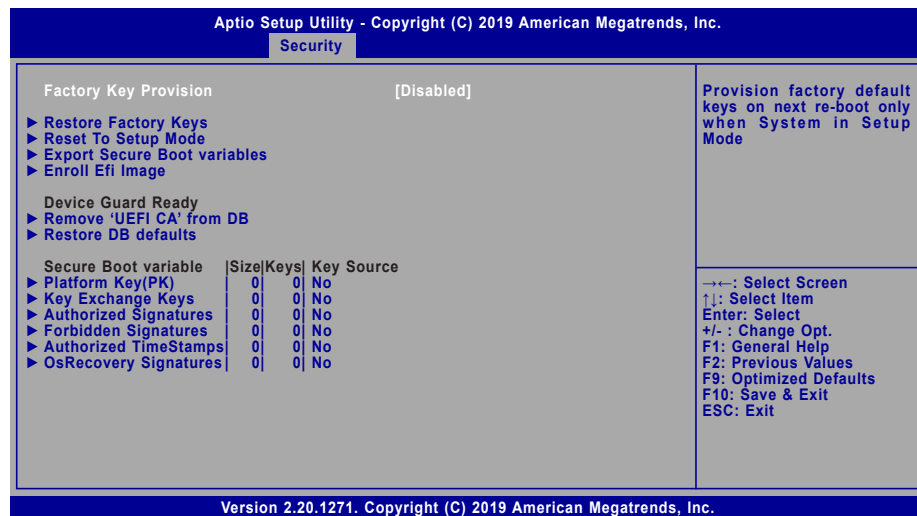

Factory Key Provision

Enable or disable the provision factory default keys on next re-start. This will only take place when the “System Mode” in the previous menu is in “Setup”, which can be achieved by moving the cursor to the “Reset To Setup Mode” and press Enter.

Restore Factory Keys

Force system to User Mode. Configure NVRAM to contain OEM-defined factory default Secure Boot keys.

Reset To Setup Mode

Clear the database from the NVRAM, including all the keys and signatures installed in the Key Management menu. Press Enter and a prompt will show up for you to confirm.

Export Secure Boot variables

Export the Secure Boot settings (i.e. all keys and signatures) as files to the root directory of a file system device. Press Enter and select a storage device listed in the pop-up menu. The saved files will be named automatically according to the type of key/signature as listed below.

- “PK” for Platform Keys
- “KEK” for Key Exchange Keys
- “db” for Authorized Signatures
- “dbx” for Forbidden Signatures

Enroll Efi Image

Allow the image to run in Secure Boot mode. Enroll SHA256 Hash certificate of a PE image into Authorized Signature Database (db). Press Enter and select a storage device listed in the pop-up menu, select a directory, and then select the EFI Image document.

Remove ‘UEFI CA’ from DB

Remove Microsoft UEFI CA from the Authorized Signature database. For systems that support Device Guard, Microsoft UEFI CA must NOT be included in the Authorized Signature database.

Restore DB defaults

Press Enter to restore the database variable to factory defaults.

Manually configure the following keys and signatures. Move the cursor to the field and press Enter, and then a pop-up menu will show up.

Platform Key(PK), Key Exchange Keys, Authorized Signatures, Forbidden Signatures, Authorized TimeStamps, OsRecovery Signatures

- Details** List the information of enrolled keys and signatures
- Export** Save the key or signature as a file to the root directory of a file system. The saved files will be named automatically according to the type of key/signature as previously listed in the “Export Secure Boot Variables”.
- Update** Load factory default database
- Append** Enroll keys and signatures from a file system
- Delete** Delet keys and signatures

► **Boot**

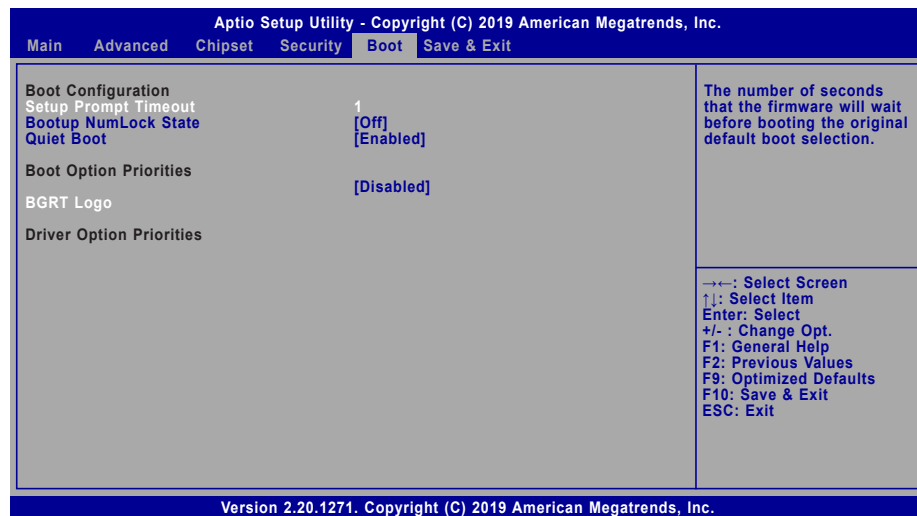

Setup Prompt Timeout

Set the number of seconds to wait for the setup activation key. 65535 (0xFFFF) denotes indefinite waiting.

Bootup NumLock State

Select the keyboard NumLock state: On or Off.

Quiet Boot

This section is used to enable or disable quiet boot option.

Boot Option Priorities

Rearrange the system boot order of available boot devices.

BGRT Logo

It is used to enable or disable to support display logo with ACPI BGRT table.

Driver Option Priorities

Rearrange the order of available drivers to be loaded.



Note:

If "Boot option filter" of "CSM Configuration" is set to "UEFI and Legacy" or "UEFI only" and "Quiet Boot" is set to enabled, "BGRT Logo" will show up for configuration. Refer to the Advanced > CSM Configuration for more information.

► **Save & Exit**

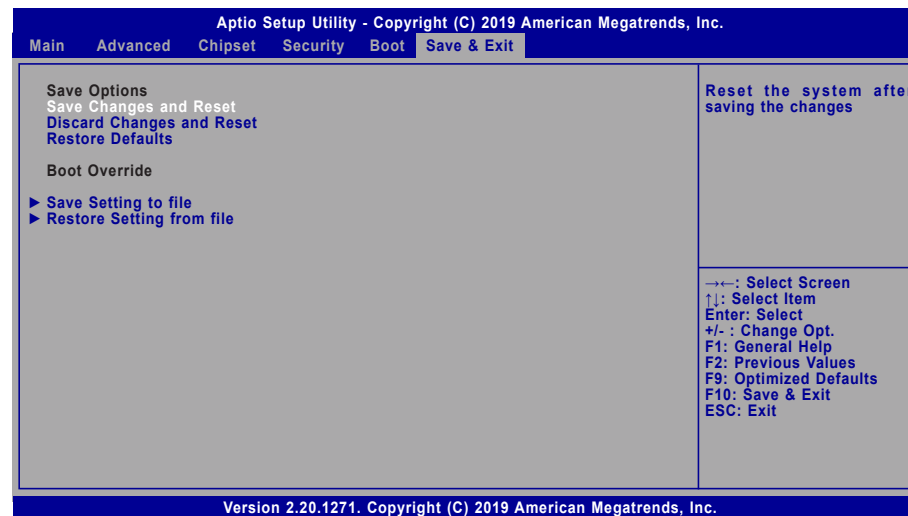

Save Changes and Reset

To save the changes, select this field and then press <Enter>. A dialog box will appear. Select Yes to reset the system after saving all changes made.

Discard Changes and Reset

To discard the changes, select this field and then press <Enter>. A dialog box will appear. Select Yes to reset the system setup without saving any changes.

Restore Defaults

To restore and load the optimized default values, select this field and then press <Enter>. A dialog box will appear. Select Yes to restore the default values of all the setup options.

Boot Override

Move the cursor to an available boot device and press Enter, and then the system will immediately boot from the selected boot device. The Boot Override function will only be effective for the current boot. The "Boot Option Priorities" configured in the Boot menu will not be changed.

► **Save Setting to file**

Select this option to save BIOS configuration settings to a USB flash device.

► **Restore Setting from file**

This field will appear only when a USB flash device is detected. Select this field to restore setting from the USB flash device.

► Updating the BIOS

To update the BIOS, you will need the new BIOS file and a flash utility. Please contact technical support or your sales representative for the files and specific instructions about how to update BIOS with the flash utility. For updating AMI BIOS in UEFI mode, you may refer to the how-to video at <https://www.dfi.com/Knowledge/Video/5>.

► Notice: BIOS SPI ROM

1. The Intel® Management Engine has already been integrated into this system board. Due to the safety concerns, the BIOS (SPI ROM) chip cannot be removed from this system board and used on another system board of the same model.
2. The BIOS (SPI ROM) on this system board must be the original equipment from the factory and cannot be used to replace one which has been utilized on other system boards.
3. If you do not follow the methods above, the Intel® Management Engine will not be updated and will cease to be effective.



Note:

- a. You can take advantage of flash tools to update the default configuration of the BIOS (SPI ROM) to the latest version anytime.
- b. When the BIOS IC needs to be replaced, you have to populate it properly onto the system board after the EEPROM programmer has been burned and follow the technical person's instructions to confirm that the MAC address should be burned or not.