



PR811-C622

1st/2nd Gen Intel® Xeon® Scalable Processor Family
User's Manual

Copyright

This publication contains information that is protected by copyright. No part of it may be reproduced in any form or by any means or used to make any transformation/adaptation without the prior written permission from the copyright holders.

This publication is provided for informational purposes only. The manufacturer makes no representations or warranties with respect to the contents or use of this manual and specifically disclaims any express or implied warranties of merchantability or fitness for any particular purpose. The user will assume the entire risk of the use or the results of the use of this document. Further, the manufacturer reserves the right to revise this publication and make changes to its contents at any time, without obligation to notify any person or entity of such revisions or changes.

Changes after the publication's first release will be based on the product's revision. The website will always provide the most updated information.

© 2023. All Rights Reserved.

Trademarks

Product names or trademarks appearing in this manual are for identification purpose only and are the properties of the respective owners.

FCC and DOC Statement on Class B

This equipment has been tested and found to comply with the limits for a Class B digital device, pursuant to Part 15 of the FCC rules. These limits are designed to provide reasonable protection against harmful interference when the equipment is operated in a residential installation. This equipment generates, uses and can radiate radio frequency energy and, if not installed and used in accordance with the instruction manual, may cause harmful interference to radio communications. However, there is no guarantee that interference will not occur in a particular installation. If this equipment does cause harmful interference to radio or television reception, which can be determined by turning the equipment off and on, the user is encouraged to try to correct the interference by one or more of the following measures:

- Reorient or relocate the receiving antenna.
- Increase the separation between the equipment and the receiver.
- Connect the equipment into an outlet on a circuit different from that to which the receiver is connected.
- Consult the dealer or an experienced radio TV technician for help.

Notice:

1. The changes or modifications not expressly approved by the party responsible for compliance could void the user's authority to operate the equipment.
2. Shielded interface cables must be used in order to comply with the emission limits.

Table of Contents

Chapter 1 - Introduction.....	6
Specifications	6
Block Diagram	9
Dimension.....	9
Chapter 2 - Hardware Installation.....	10
Board Layout.....	10
Jumper Settings	11
Clear CMOS Data (JP15)	11
ME Firmware Update (JP16).....	11
Flash Security Override (JP8).....	12
Pin Assignment	13
Front Audio- Line In (J53).....	13
CPU and System Fans (J17, J20, J22, J46, J47, J48).....	13
Front Panel (J24).....	14
SMBus (J5)	14
Front Audio (J56).....	15
BMC UART (J27).....	15
USB2_8/9 (J29)	16
PS2 (SOJ1)	16
LPC_for Debug Port 80 (J4)	17
USB3_5/6 (J54)	18
SEM2500 Golden Finger Pin Assignment	19
System Memory	23
Installing the DIMM Module	23
Removing the DIMM Module.....	24
Expansion Slots.....	25
Installing the M.2 Module	25
Chapter 3 - BIOS Settings.....	27
Overview	27
Main.....	28
Advanced	28
ACPI Configuration.....	29
CPU Configuration.....	29
Video Configuration.....	30
SATA Configuration	30
SATA Configuration ▶ PCH SATA Configuration	31
SATA Configuration ▶ PCH sSATA Configuration	31
USB Configuration	32
PCI Express Configuration	32
Debug Configuration	33
UEFI Device Manager	34
USB Power Control.....	34
SIO NCT6112D.....	35
SIO NCT6112D ▶ Hardware Monitor.....	36
SIO NCT7802Y ▶ Hardware Monitor.....	37
Console Redirection	38
Security	39
Boot	39
Save & Exit	40
Updating the BIOS.....	41
Notice: BIOS SPI ROM.....	41

About this Manual

This manual can be downloaded from the website.

The manual is subject to change and update without notice, and may be based on editions that do not resemble your actual products. Please visit our website or contact our sales representatives for the latest editions.

Warranty

1. Warranty does not cover damages or failures that occur from misuse of the product, inability to use the product, unauthorized replacement or alteration of components and product specifications.
2. The warranty is void if the product has been subjected to physical abuse, improper installation, modification, accidents or unauthorized repair of the product.
3. Unless otherwise instructed in this user's manual, the user may not, under any circumstances, attempt to perform service, adjustments or repairs on the product, whether in or out of warranty. It must be returned to the purchase point, factory or authorized service agency for all such work.
4. We will not be liable for any indirect, special, incidental or consequential damages to the product that has been modified or altered.

Static Electricity Precautions

It is quite easy to inadvertently damage your PC, system board, components or devices even before installing them in your system unit. Static electrical discharge can damage computer components without causing any signs of physical damage. You must take extra care in handling them to ensure against electrostatic build-up.

1. To prevent electrostatic build-up, leave the system board in its anti-static bag until you are ready to install it.
2. Wear an antistatic wrist strap.
3. Do all preparation work on a static-free surface.
4. Hold the device only by its edges. Be careful not to touch any of the components, contacts or connections.
5. Avoid touching the pins or contacts on all modules and connectors. Hold modules or connectors by their ends.



Important:

Electrostatic discharge (ESD) can damage your processor, disk drive and other components. Perform the upgrade instruction procedures described at an ESD workstation only. If such a station is not available, you can provide some ESD protection by wearing an antistatic wrist strap and attaching it to a metal part of the system chassis. If a wrist strap is unavailable, establish and maintain contact with the system chassis throughout any procedures requiring ESD protection.

Safety Measures

- To avoid damage to the system, use the correct AC input voltage range.
- To reduce the risk of electric shock, unplug the power cord before removing the system chassis cover for installation or servicing. After installation or servicing, cover the system chassis before plugging the power cord.

About the Package

The package contains the following items. If any of these items are missing or damaged, please contact your dealer or sales representative for assistance.

- 1 PR811-C622 motherboard
- 1 I/O shield
- 1 M.2 screw for 2280
- 1 CPU clip
- 1 SEM 2500/2510 (by orderd P/N)

The board and accessories in the package may not come similar to the information listed above. This may differ in accordance with the sales region or models in which it was sold. For more information about the standard package in your region, please contact your dealer or sales representative.

Before Using the System Board

When installing the system board in a new system, you will need at least the following internal components.

- Memory module
- Storage device such as a hard disk drive.
- Power supply

External system peripherals may also be required for navigation and display, including at least a keyboard, a mouse and a video display monitor.

Chapter 1 - Introduction

► Specifications

SYSTEM	Processor	<p>1st Generation Intel® Xeon® Scalable Processor Family, LGA 3647 Socket:</p> <p>Intel® Xeon® Platinum 8160T (24 Cores, 27.5M Cache, up to 3.7 GHz); 150W Intel® Xeon® Gold 6138T (20 Cores, 27.5M Cache, up to 3.7 GHz); 125W Intel® Xeon® Gold 6138 (20 Cores, 27.5M Cache, up to 3.7 GHz); 125W Intel® Xeon® Gold 6130T (16 Cores, 22M Cache, up to 3.7 GHz); 125W Intel® Xeon® Gold 6130 (16 Cores, 22M Cache, up to 3.7 GHz); 125W Intel® Xeon® Gold 6126T (12 Cores, 19.25M Cache, up to 3.7 GHz); 125W Intel® Xeon® Gold 6126 (12 Cores, 19.25M Cache, up to 3.7 GHz); 125W Intel® Xeon® Gold 5120T (14 Cores, 19.25M Cache, up to 3.2 GHz); 105W Intel® Xeon® Gold 5119T (14 Cores, 19.25M Cache, up to 3.2 GHz); 85W Intel® Xeon® Gold 5118 (12 Cores, 16.5M Cache, up to 3.2 GHz); 105W Intel® Xeon® Silver 4116T (12 Cores, 16.5M Cache, up to 3.0 GHz); 85W Intel® Xeon® Silver 4116 (12 Cores, 16.5M Cache, up to 3.0 GHz); 85W Intel® Xeon® Silver 4114T (10 Cores, 13.75M Cache, up to 3.0 GHz); 85W Intel® Xeon® Silver 4110 (8 Cores, 11M Cache, up to 3.0 GHz); 85W Intel® Xeon® Silver 4109T (8 Cores, 11M Cache, up to 3.0 GHz); 70W Intel® Xeon® Bronze 3106 (8 Cores, 11M Cache, 1.7 GHz); 85W</p> <p>2nd Generation Intel® Xeon® Scalable Processor Family, LGA 3647 Socket:</p> <p>Intel® Xeon® Gold 6252N (24 Cores, 35.75M Cache, up to 3.6 GHz); 150W Intel® Xeon® Gold 6238T (22 Cores, 30.25M Cache, up to 3.7 GHz); 125W Intel® Xeon® Gold 6230T (20 Cores, 27.5M Cache, up to 3.9 GHz); 125W Intel® Xeon® Gold 6230N (20 Cores, 27.5M Cache, up to 3.5 GHz); 125W Intel® Xeon® Gold 6230 (20 Cores, 27.5M Cache, up to 3.9 GHz); 125W Intel® Xeon® Gold 6226 (12 Cores, 19.25M Cache, up to 3.7 GHz); 125W Intel® Xeon® Gold 5220T (18 Cores, 24.75M Cache, up to 3.9 GHz); 105W Intel® Xeon® Gold 5218T (16 Cores, 22M Cache, up to 3.8 GHz); 105W Intel® Xeon® Gold 5218N (16 Cores, 22M Cache, up to 3.7 GHz); 110W Intel® Xeon® Gold 5215 (10 Cores, 13.75M Cache, up to 3.4 GHz); 85W Intel® Xeon® Silver 4216 (16 Cores, 22M Cache, up to 3.2 GHz); 100W Intel® Xeon® Silver 4215 (8 Cores, 11M Cache, up to 3.5 GHz); 85W Intel® Xeon® Silver 4214 (12 Cores, 16.5M Cache, up to 3.2 GHz); 85W Intel® Xeon® Silver 4210 (10 Cores, 13.75M Cache, up to 3.2 GHz); 85W Intel® Xeon® Silver 4209 (8 Cores, 11M Cache, up to 3.2 GHz); 70W</p>
	Chipset	Intel® C622 Chipset
	Memory	12 x 288-pin ECC-RDIMM up to 768GB Single Channel DDR4 2133/2400/2666/2933 MHZ
	BIOS	Insyde
GRAPHICS	Display	1 x VGA (Optional) VGA: resolution up to 1920x1200 @ 60Hz
	Single Displays	VGA (Optional)

EXPANSION	Interface	5 x PCIe x16 (Gen 3) 1 x PCIe x8 (Gen 3) 1 x M.2 2280 M key (PCIe Gen3 x4 NVMe/SATA) 1 x BMC Module slot for SEM2500/2510 Note: PCIe x8 slot is OPEN edge.
AUDIO	Audio Codec	Realtek ALC887
ETHERNET	Controller	2 x Intel® I210AT (10/100/1000Mbps) 1 x Intel® x557-AT2 (10GbE)
REAR I/O	Serial	1x RS-232 (DB-9)
	Ethernet	2 x GbE (RJ-45) 2 x 10 GbE x557-AT2 IPMI 2.0
	USB	4 x USB 3.2 Gen1 2 x USB 2.0 stack (opt.w/ RJ45 + USB2.0 stack)
	Display	1 x VGA (optional)
INTERNAL I/O	Serial	1 x RS-232
	USB	2 x USB 3.2 Gen1 2 x USB 2.0 1 x USB 2.0 Vertical Type A
	SATA	8 x SATA 3 (up to 6Gb/s) RAID 0/1/5/10
	SMBus	1 x SMBus
WATCHDOG TIMER	Output & Interval	System Reset, Programmable via Software from 1 to 255 Seconds
SECURITY	TPM	TPM 2.0
POWER	Type	ATX
	Connector	8-pin ATX 12V power 24-pin ATX power
	Consumption	TBD
	RTC Battery	CR2032 Coin Cell

OS SUPPORT		Windows 10 IoT Enterprise LTSB RS5(64-bit) Windows Server 2019 Windows Server 2016 Linux
ENVIRONMENT	Temperature	Operating: 0 to 40°C Storage: -40 to 85°C
	Humidity	Operating: 5 to 90% RH Storage: 5 to 90% RH
	MTBF	TBD
MECHANISM	Dimensions	EATX Form Factor: 305mm (12") x 330mm (13")
	Height	PCB: TBD Top Side: TBD Bottom Side: TBD

► Block Diagram

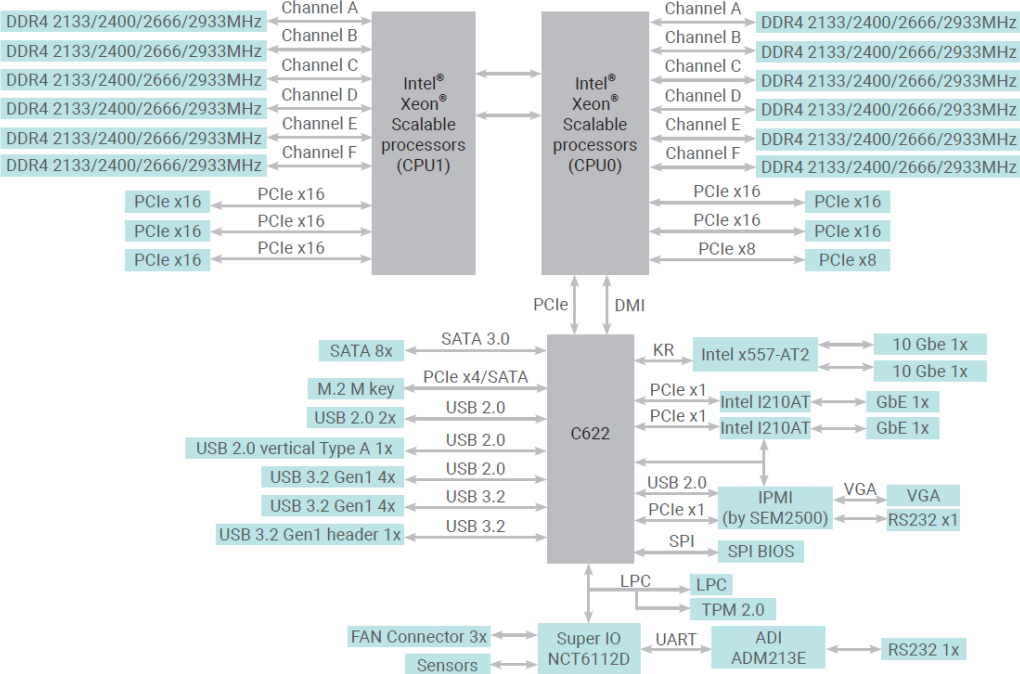

► Dimension

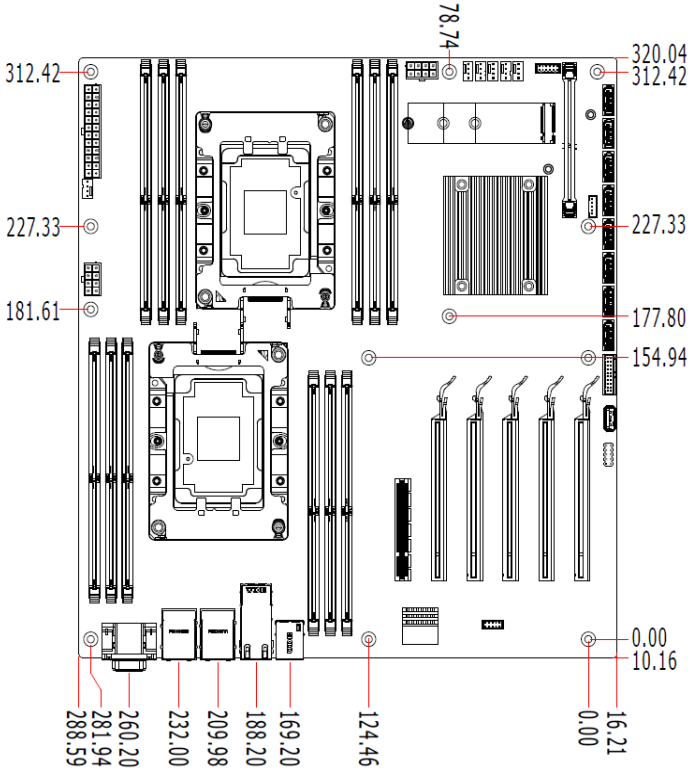

Chapter 2 - Hardware Installation

Board Layout

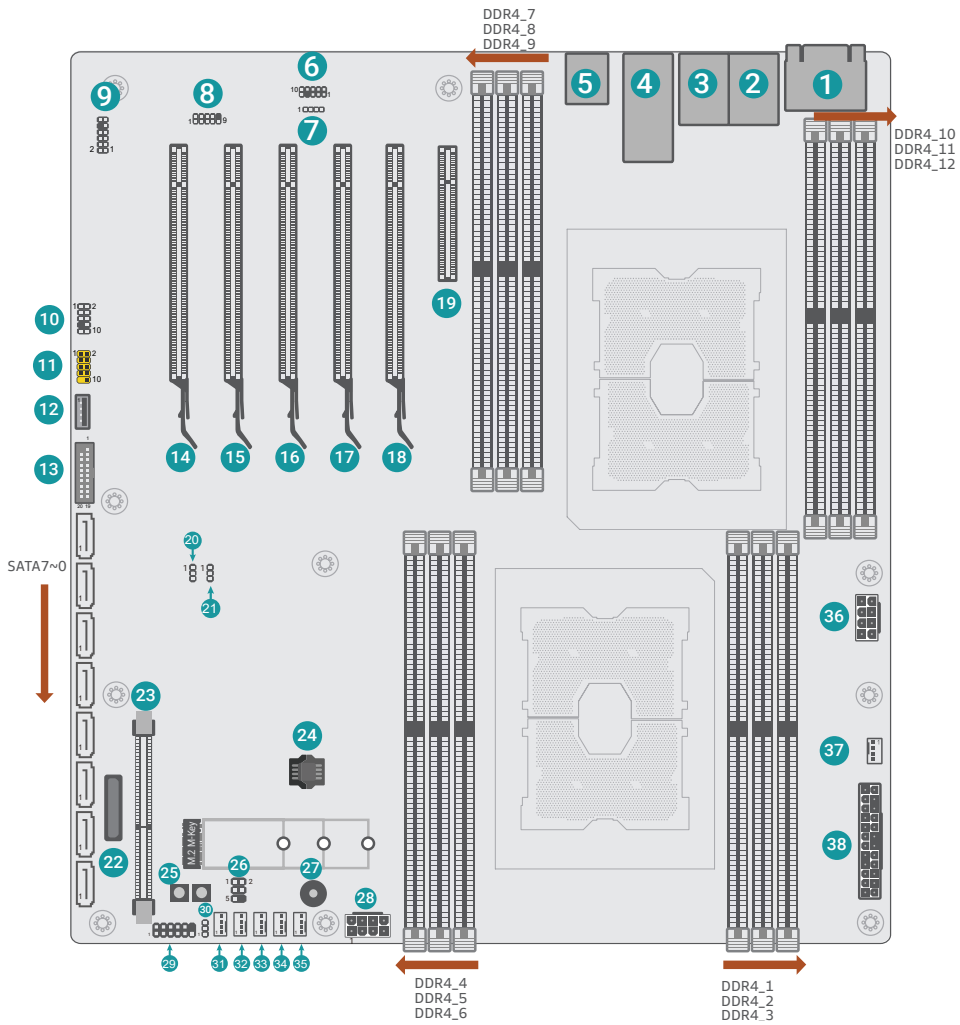

- 1 ▲ VGA
▼ COM1
- 2 ▲ LAN
▼ USB3.2 Gen1
- 3
- 4 10G LAN
- 5 MGMT
- 6 Front Audio
- 7 Front Audio (Line In)
- 8 BMC UART
- 9 LPC (for Debug Port 80)
- 10 PS2
- 11 USB2_8/9
- 12 USB2.0
- 13 USB3_5/6
- 14 PCIE 6
- 15 PCIE 5
- 16 PCIE 4
- 17 PCIE 3
- 18 PCIE 2
- 19 PCIE 1
- 20 ME Firmware Update
- 21 Clear CMOS Data
- 22 Battery
- 23 BMC DDR4 SO-DIMM
- 24 SPI
- 25 Reset Power
- 26 SMBus
- 27 Buzzer
- 28 12V ATX Power
- 29 Front Panel
- 30 Flash Security Override
- 31 System Fan 4
- 32 System Fan 3
- 33 System Fan 2
- 34 System Fan 1
- 35 CPU Fan 1
- 36 12V ATX Power
- 37 CPU FAN 2
- 38 ATX Power

► Jumper Settings

Clear CMOS Data (JP15)

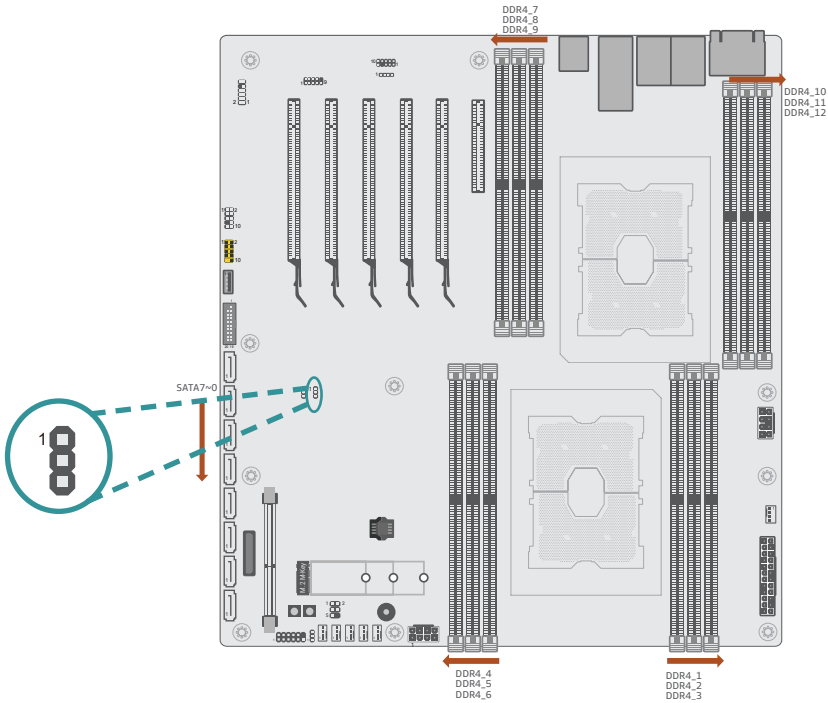

■ 1-2 On: Normal (Default)



■ 2-3 On: Clear RTC Registers

ME Firmware Update (JP16)

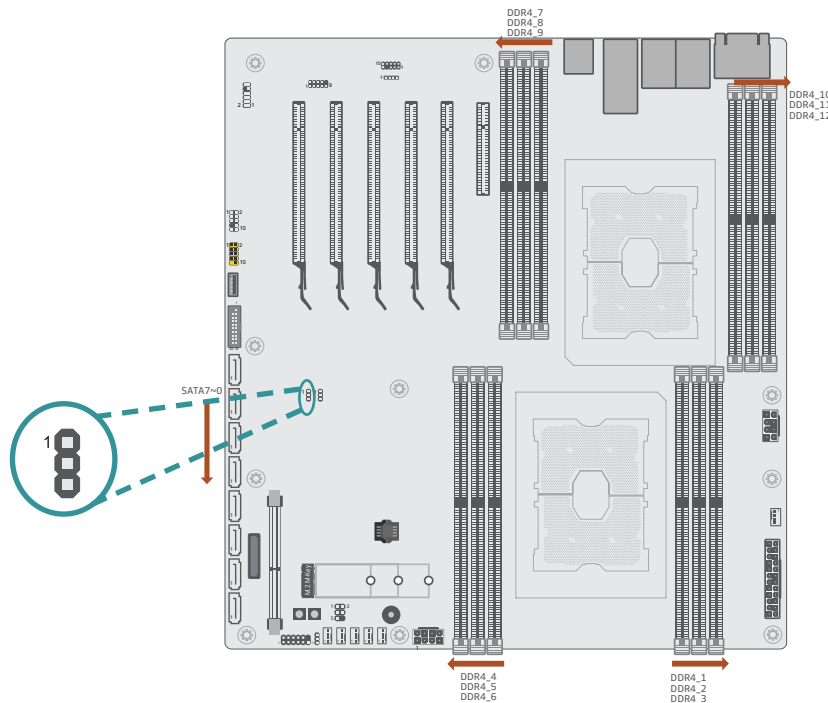

■ 1-2 On: Normal (Default)



■ 2-3 On: ME Force Update

Flash Security Override (JP8)

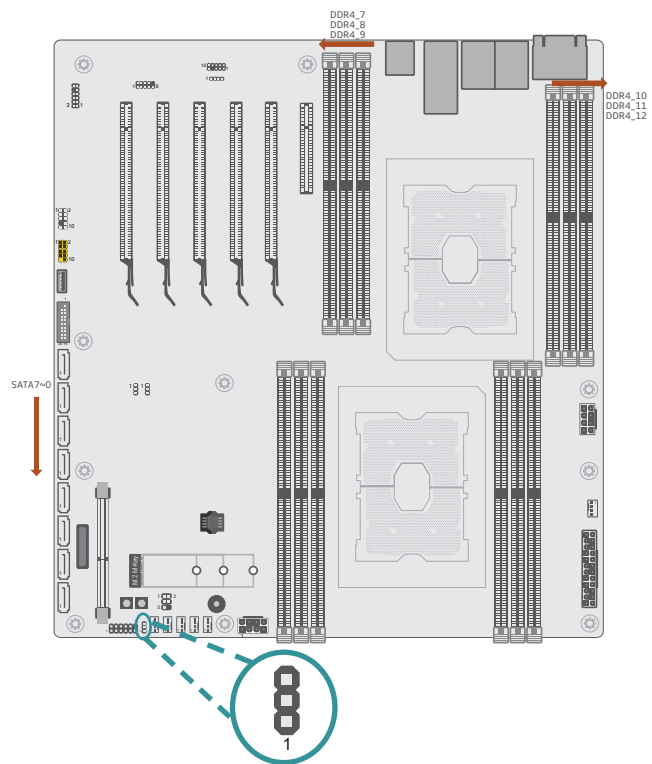

■ 1-2 On: Disable (Default)



■ 2-3 On: Enable

► Pin Assignment

Front Audio- Line In (J53)

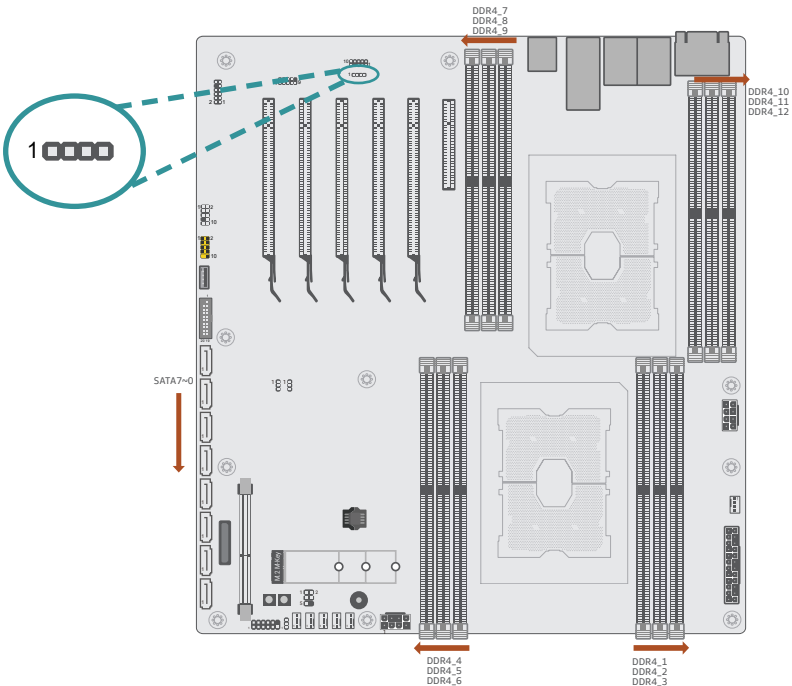

Pin	Assignment
1	LINE1-R
2	LINE1-JD
3	GND
4	LINE1-L

CPU and System Fans (J17, J20, J22, J46, J47, J48)

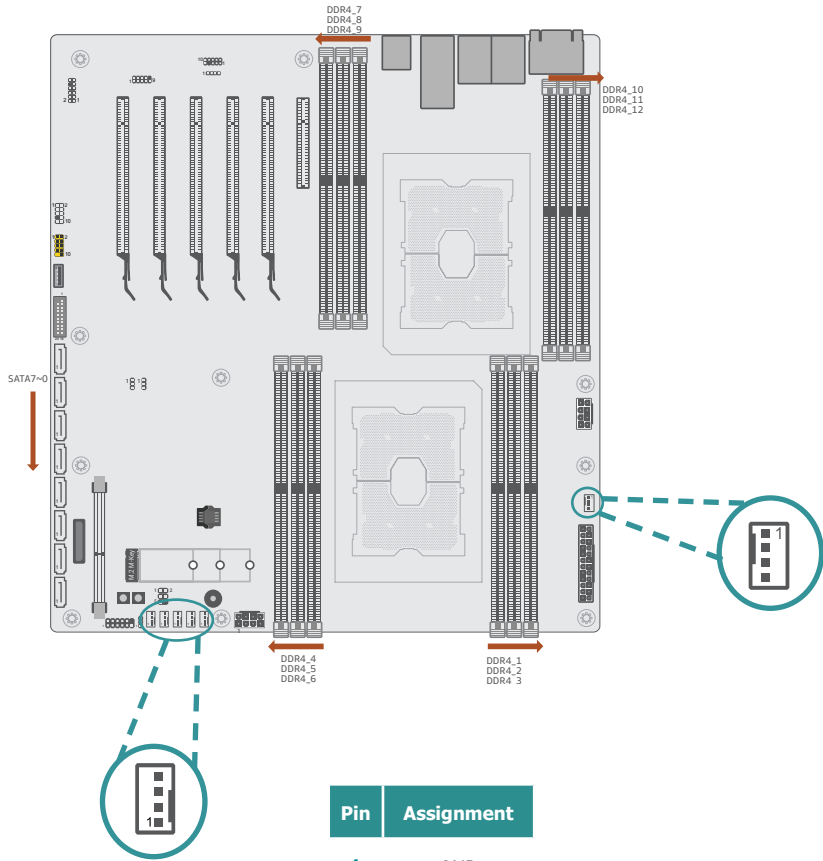

Pin	Assignment
1	GND
2	+12V
3	Sense
4	Speed Control

Front Panel (J24)

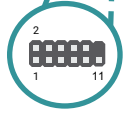
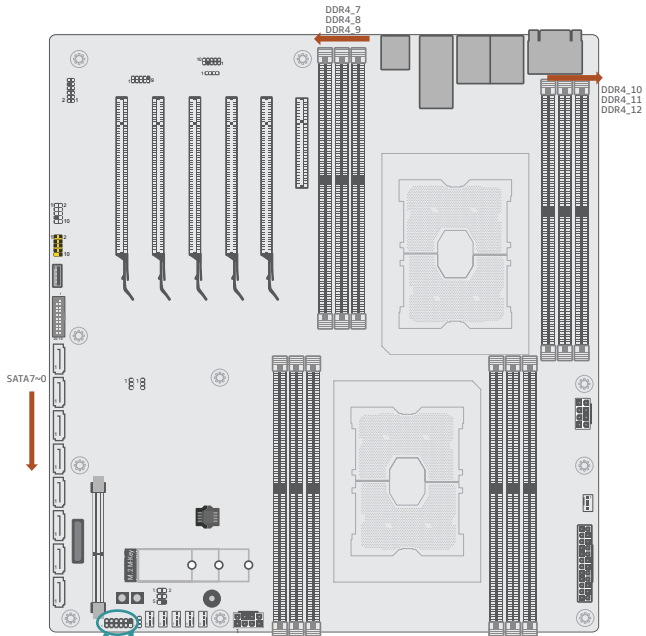

Pin	Assignment		Pin	Assignment
1	N.C.	PWR-LED	2	LED Power
3	HDD Power		4	LED Power
5	Signal		6	Signal
7	Ground	ATX-SW	8	Ground
9	Signal		10	Signal
11	N.C.		12	---

SMBus (J5)

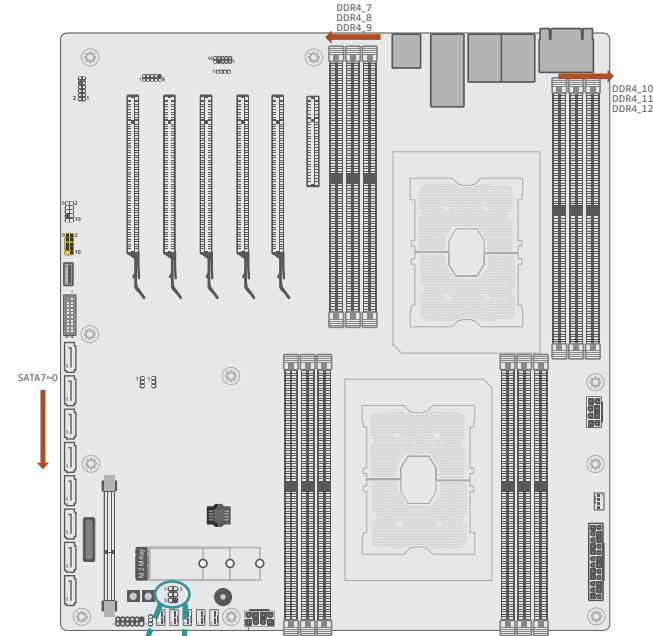

Pin	Assignment	Pin	Assignment
1	3V3_AUX	2	GND
3	SMB_HOST_STBY_LVC3_SCL	4	SMB_HOST_STBY_LVC3_SDA
5	PU_PCH_TLS_ENABLE_STRAP	6	---

Front Audio (J56)

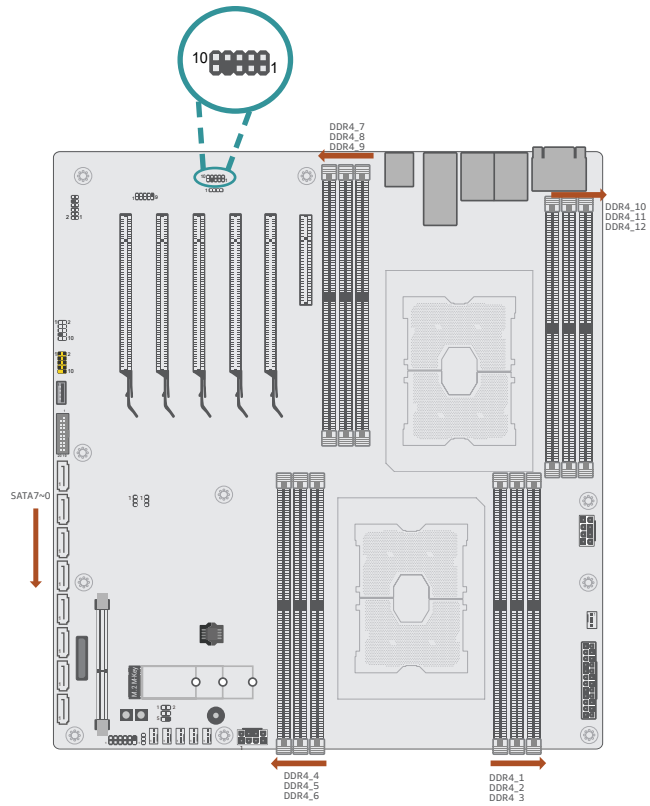

Pin	Assignment	Pin	Assignment
1	GND	2	Mic2-L
3	N.C.	4	Mic2-R
5	Mic2-JD	6	Line2-R
7	--	8	GND
9	Line2-JD	10	Line2-L

BMC UART (J27)

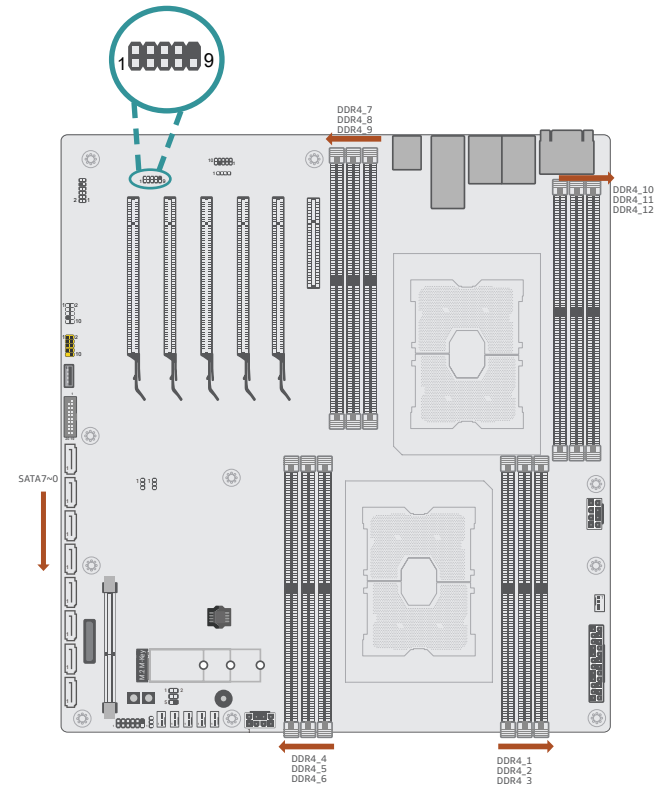

Pin	Assignment	Pin	Assignment
1	MDCD1-	2	MRD1
3	MTD1	4	MDTR1-
5	GND	6	MDSR1-
7	MRTS1-	8	MCTS1-
9	MRI1-	10	---

USB2_8/9 (J29)

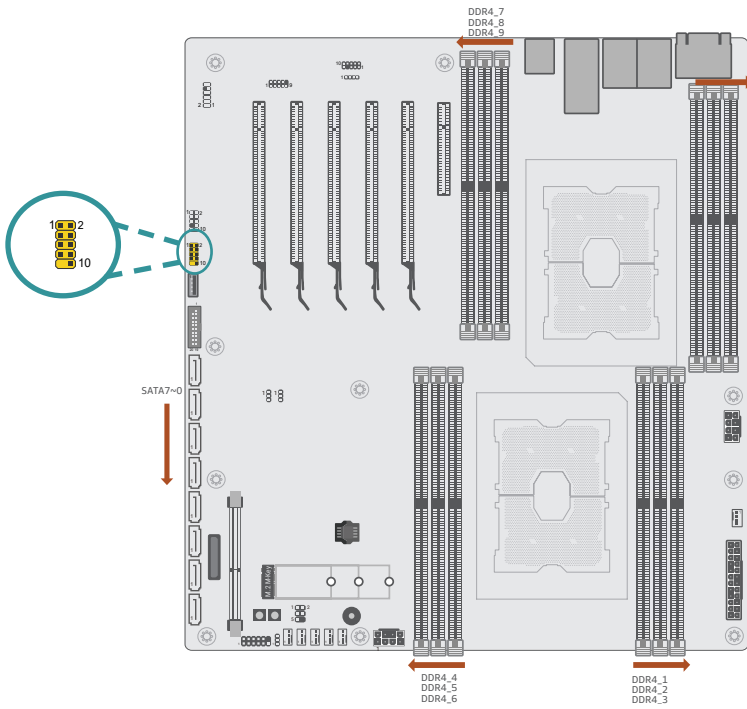

Pin	Assignment	Pin	Assignment
1	VCC	2	VCC
3	USB8_D-	4	USB9_D-
5	USB8_D+	6	USB9_D+
7	GND	8	GND
9	KEY	10	N.C.

PS2 (SOJ1)

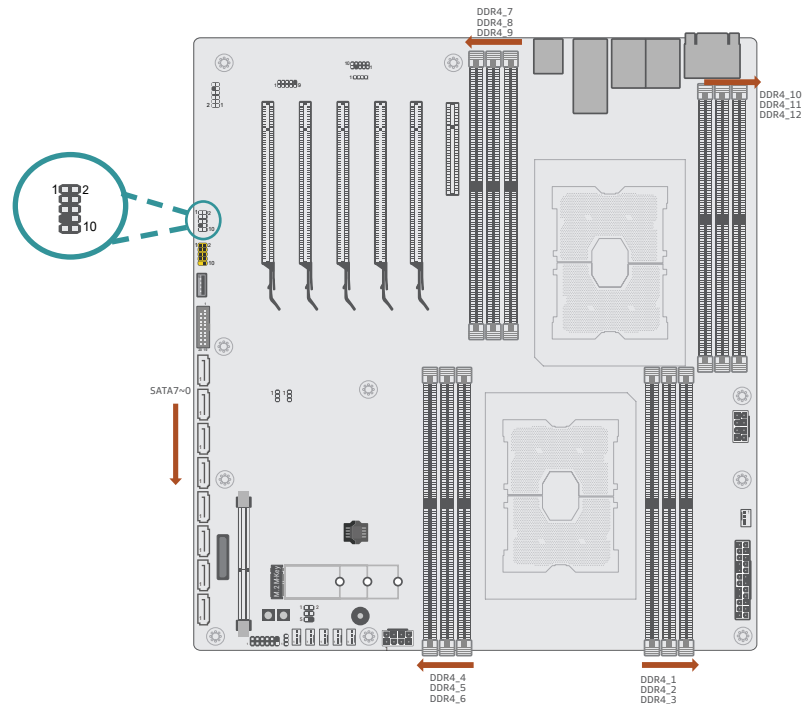

Pin	Assignment	Pin	Assignment
1	PS2_KCLK	2	PS2_MCLK
3	PS2_KDAT	4	PS2_MDAT
5	GND	6	GND
7	NC	8	GND
9	BVCC	10	BVCC

LPC_for Debug Port 80 (J4)

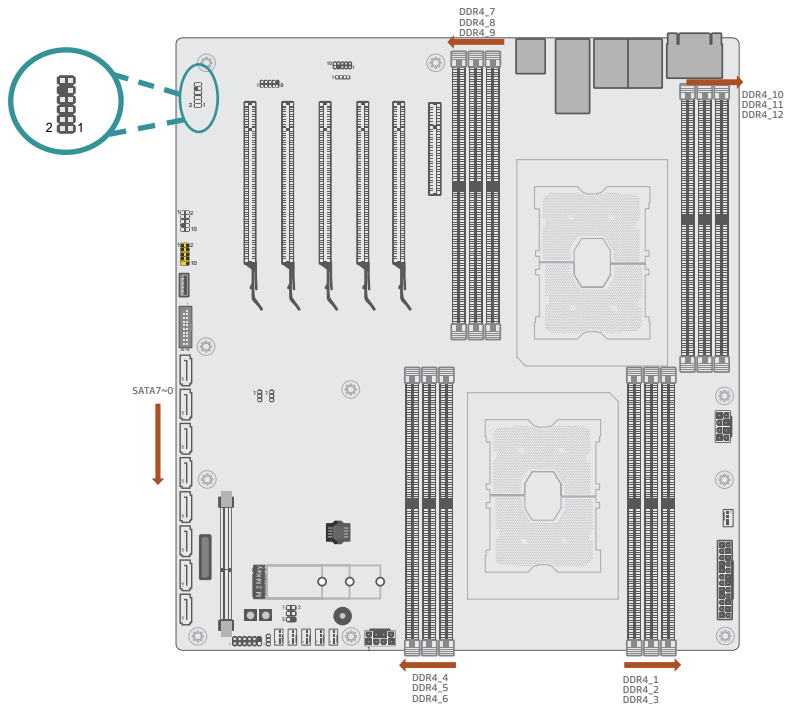

Pin	Assignment	Pin	Assignment
1	CLK	2	LAD1
3	RST#	4	LAD0
5	Frame#	6	3V3
7	LAD3	8	GND
9	LAD2	10	---
11	SERIRQ	12	N.C.

USB3_5/6 (J54)

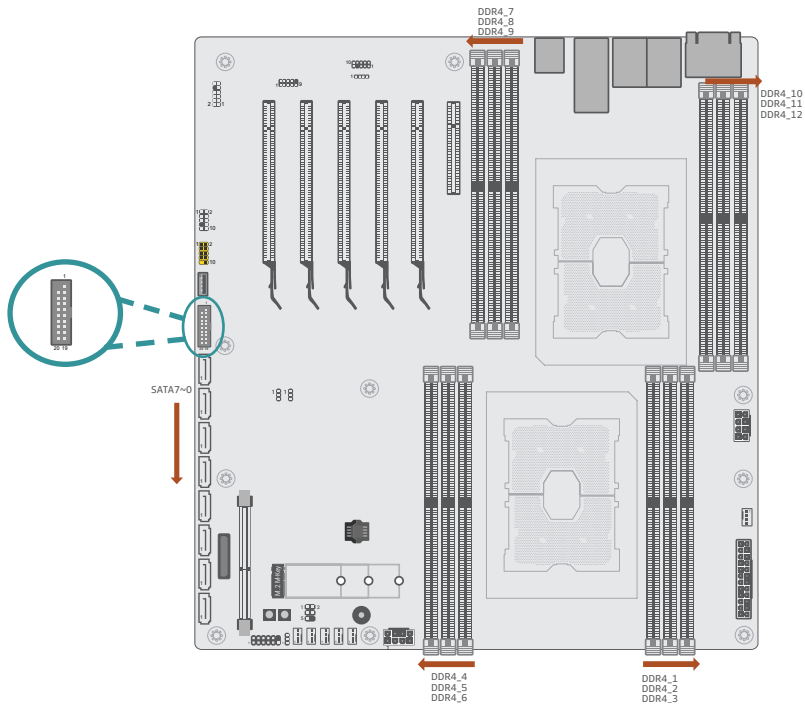

Pin	Assignment	Pin	Assignment
1	PWR	2	D2+
3	SSRX1-	4	D2-
5	SSRX1+	6	GND
7	GND	8	SSTX2+
9	SSTX1-	10	SSTX2-
11	SSTX1+	12	GND
13	GND	14	SSRX2+
15	D1-	16	SSRX2-
17	D2+	18	PWR
19	N.C.	20	---

► **SEM2500 Golden Finger Pin Assignment**

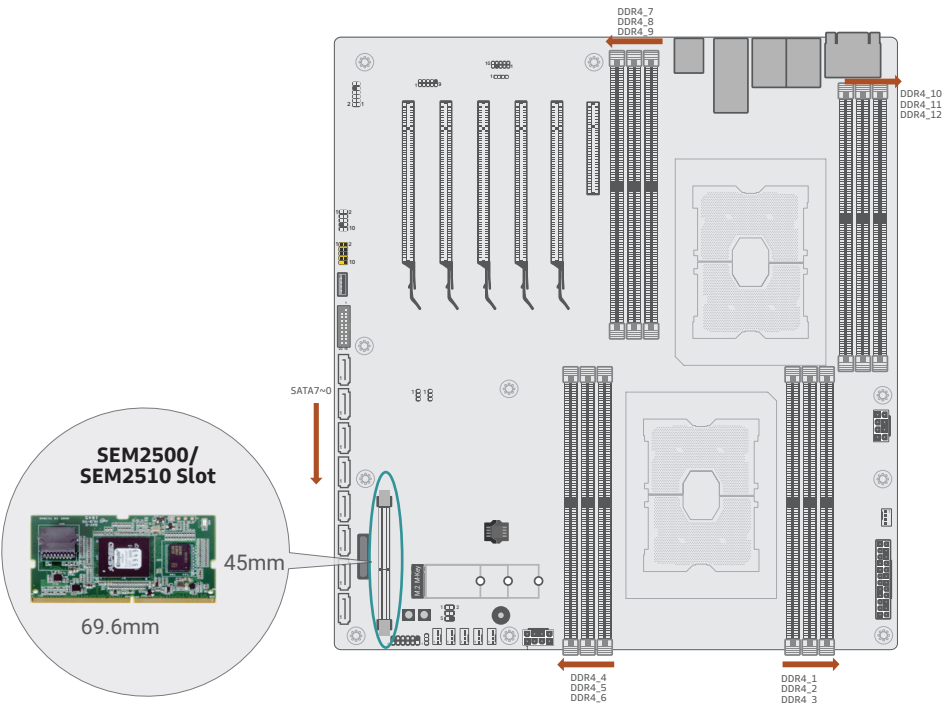

Pin	Assignment	Pin	Assignment
1	GND	26	GND
2	GND	27	GND
3	8211_BMC_RXCK	28	8211_BMC_TXCLK
4	8211_BMC_RXD0	29	8211_BMC_TXD2
5	GND	30	GND
6	GND	31	GND
7	8211_BMC_RXCTL	32	BMC_USB2_P
8	8211_BMC_RXD1	33	8211_BMC_TXD3
9	GND	34	BMC_USB2_N
10	GND	35	GND
11	8211_BMC_MDC2	36	GND
12	8211_BMC_RXD2	37	NCSI_BMC_MAC1_CRSDV
13	8211_BMC_MDIO2	38	NCSI_BMC_MAC1_TXEN
14	GND	39	GND
15	GND	40	GND
16	8211_BMC_RXD3	41	NCSI_OSC_CLK50M
17	8211_RGMII_BMC_CLK	42	NCSI_BMC_MAC1_TXD0
18	GND	43	GND
19	GND	44	GND
20	N.C.	45	NCSI_BMC_MAC1_RXD0
21	8211_BMC_TXD0	46	NCSI_BMC_MAC1_TXD1
22	GND	47	GND
23	GND	48	GND
24	8211_BMC_TXCTL	49	NCSI_BMC_MAC1_RXD1
25	8211_BMC_TXD1	50	VGA_IBMC_BLUE

Pin	Assignment	Pin	Assignment
51	GND	76	CLK_100M_IBMC_PE_N
52	GND	77	GND
53	BMC_USB1_P	78	GND
54	VGA_IBMC_GREEN	79	LPC_LAD0_IO0
55	BMC_USB1_N	80	IRQ_BMC_PCH_SMI_LPC_N
56	GND	81	GND
57	GND	82	GND
58	VGA_IBMC_RED	83	LPC_LAD0_IO1
59	VGA_IBMC_DDCCLK	84	FM_PCH_BMC_THERMTRIP_N
60	GND	85	GND
61	GND	86	GND
62	VGA_IBMC_HSYNC	87	LPC_LAD0_IO2
63	VGA_IBMC_DDCDAT	88	BMC_SMB_SCL1
64	GND	89	GND
65	GND	90	GND
66	VGA_IBMC_VSYNC	91	LPC_LAD0_IO3
67	CLK_24M_33M_LPC	92	BMC_SMB_SDA1
68	GND	93	GND
69	GND	94	GND
70	LPC_LFRAME_N	95	P3E_PCH_TO_BMC_C_P
71	IRQ_LPC_SERIRQ_N	96	BMC_SMB_SCL2
72	GND	97	P3E_PCH_TO_BMC_C_N
73	GND	98	GND
74	CLK_100M_IBMC_PE_P	99	GND
75	RST_PLTRST_N	100	BMC_SMB_SDA2

Pin	Assignment	Pin	Assignment
101	FM_SLPS4_N	126	BMC_GPIOA2
102	GND	127	BMC_GPIOA1
103	GND	128	BMC_GPIOA3
104	PCIE_BMC_RST_N	129	3V3SB
105	FM_SLPS3_N	130	3V3SB
106	GND	131	BMC_GPIOQ4
107	GND	132	BMC_GPIOQ6
108	P3E_BMC_TO_PCH_C_P	133	BMC_GPIOQ5
109	MISC_IBMC_SRST_N	134	BMC_GPIOQ7
110	P3E_BMC_TO_PCH_C_N	135	3V3SB
111	N.C.	136	3V3SB
112	N.C.	137	N.C.
113	SPI_BMC_CS_N	138	ADC8_POWER
114	SPI_BMC_MOSI	139	ADC1_POWER
115	SPI_BMC_CLK	140	ADC9_POWER
116	SPI_BMC_MISO	141	3V3SB
117	3V3SB	142	3V3SB
118	3V3SB	143	ADC2_POWER
119	SPI_PCH_CS_N	144	ADC10_POWER
120	SPI_PCH_DO	145	ADC3_POWER
121	SPI_PCH_CK	146	ADC11_POWER
122	SPI_PCH_DI	147	3V3SB
123	3V3SB	148	3V3SB
124	3V3SB	149	ADC4_POWER
125	BMC_GPIOA0	150	ADC12_POWER

Pin	Assignment	Pin	Assignment
201	GND	226	GND
202	GND	227	GND
203	BMC_SMB_SDA6	228	RS232_BMC_RXD
204	BMC_SMB_SDA5	229	FAN_PWM0
205	GND	230	GND
206	GND	231	GND
207	BMC_SMB_SCL7	232	FAN_PWM3
208	BMC_SMB_SCL8	233	FAN_PWM1
209	GND	234	GND
210	GND	235	GND
211	BMC_SMB_SDA7	236	FAN_PWM4
212	BMC_SMB_SDA8	237	FAN_PWM2
213	GND	238	GND
214	GND	239	GND
215	RS232_BMC_CTS	240	FAN_PWM5
216	RS232_BMC_DTR	241	FAN_TACH0
217	GND	242	FAN_PWM6
218	GND	243	GND
219	RS232_BMC_DCD	244	GND
220	RS232_BMC_RTS	245	FAN_TACH1
221	RS232_BMC_DSR	246	FAN_PWM7
222	GND	247	GND
223	GND	248	GND
224	RS232_BMC_TXD	249	FAN_TACH3
225	RS232_BMC_NRI	250	FAN_TACH2

Pin	Assignment	Pin	Assignment
151	ADC5_POWER	176	GND
152	ADC13_POWER	177	IRQ_BMC_PCH_NMI
153	3V3SB	178	PGPPA_SB_EN
154	3V3SB	179	FM_NMI_EVENT_N
155	ADC6_POWER	180	GND
156	ADC14_POWER	181	GND
157	ADC7_POWER	182	FM_SMI_ACTIVE_N
158	ADC15_POWER	183	PVCCIO_CPU0
159	3V3SB	184	GND
160	3V3SB	185	GND
161	N.C.	186	PRESENT1
162	N.C.	187	PECL_BMC
163	3V3SB	188	GND
164	P3V_BAT	189	GND
165	1V15SB_PWRGD	190	PRESENT2
166	RERST_BTN_OUT_N	191	BMC_SMB_SCL4
167	GND	192	GND
168	GND	193	GND
169	FP_LED_STATUS_GREEN_N	194	BMC_SMB_SCL3
170	FP_LED_STATUS_AMBER_N	195	BMC_SMB_SDA4
171	GND	196	GND
172	GND	197	GND
173	PWRBTN_OUT_N	198	BMC_SMB_SDA3
174	FM_BMC_PCH_SCL_LPC_N	199	BMC_SMB_SCL6
175	GND	200	BMC_SMB_SCL5

Pin	Assignment
251	GND
252	GND
253	FAN_TACH4
254	FAN_TACH5
255	N.C.
256	FAN_TACH6
257	5VDU
258	12V
259	5VDU
260	FAN_TACH7



Note:

The optional DDR4 SO-DIMM socket for the SEM2500/SEM2510 module supports additional IPMI management, BMC, and VGA output.

► System Memory

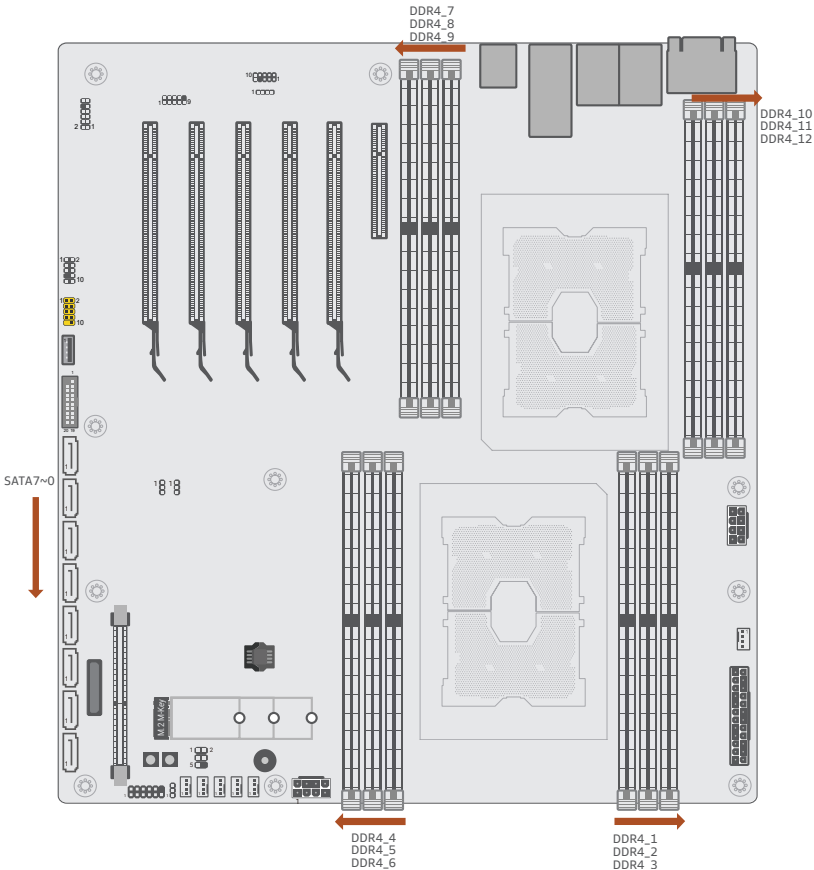

Installing the DIMM Module

Before installing the memory module, please make sure that the following safety cautions are well-attended.

- 1. Make sure the PC and all other peripheral devices connected to it has been powered down.
- 2. Disconnect all power cords and cables.
- 3. Locate the DIMM socket on the system board
- 4. Make sure the notch on memory card is aligned to the key on the socket.

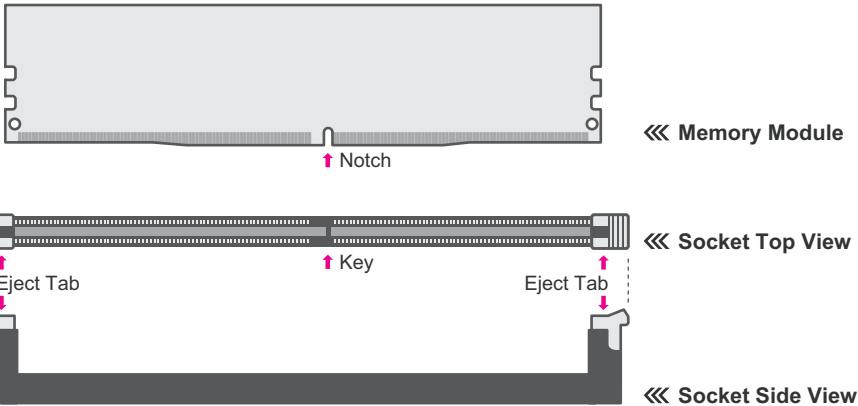

The system board supports the following memory interface.

Single Channel (SC)

Data will be accessed in chunks of 64 bits from the memory channels. DIMMs are on the same channel. DIMMs in a channel can be identical or completely different. However, we highly recommend using identical DIMMs. Not all slots need to be populated.

Dual Channel (DC)

Data will be accessed in chunks of 128 bits from the memory channels. Dual channel provides better system performance because it doubles the data transfer rate.

Please follow the steps below to install the memory card into the socket.

Step 1:
Press the eject tabs at both ends of the socket outward and downward to release them from the locked position.

Step 2:
Insert the memory card into the slot while making sure the notch and the key are aligned. Press the card down firmly with fingers while applying and maintaining even pressure on both ends.

Step 3:
The tabs snap automatically to the edges of the card and lock the card in place.

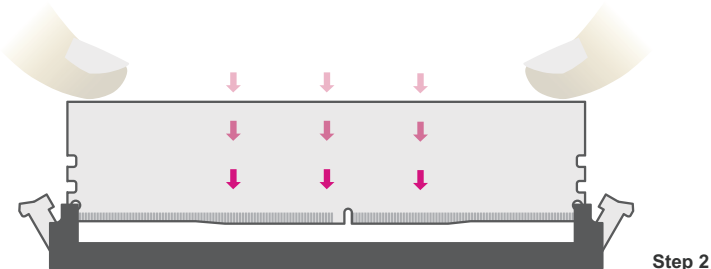

Removing the DIMM Module

Please follow the steps below to remove the memory card from the socket.

Step 1:
Press the eject tabs at both ends of the socket outward and downward to release them from the locked position.

Step 2:
The memory card ejects from the slot automatically.

Step 3:
Hold the card by its edges and remove it from the slot.

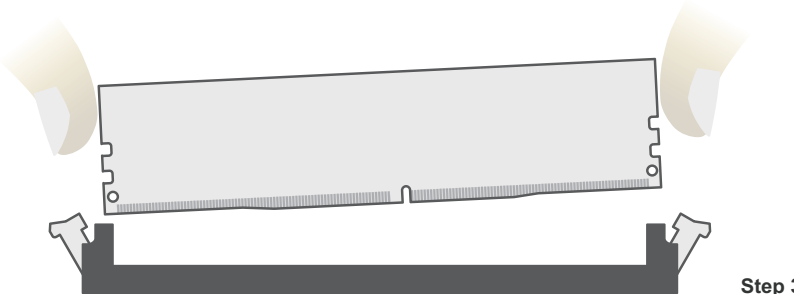
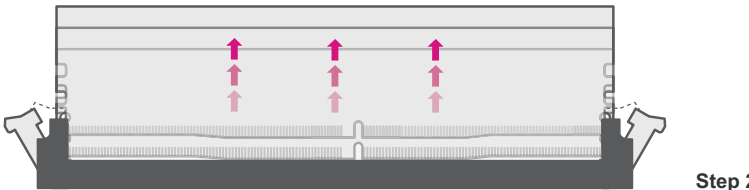
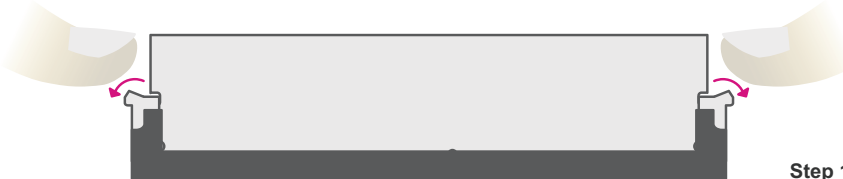

► **Expansion Slots**

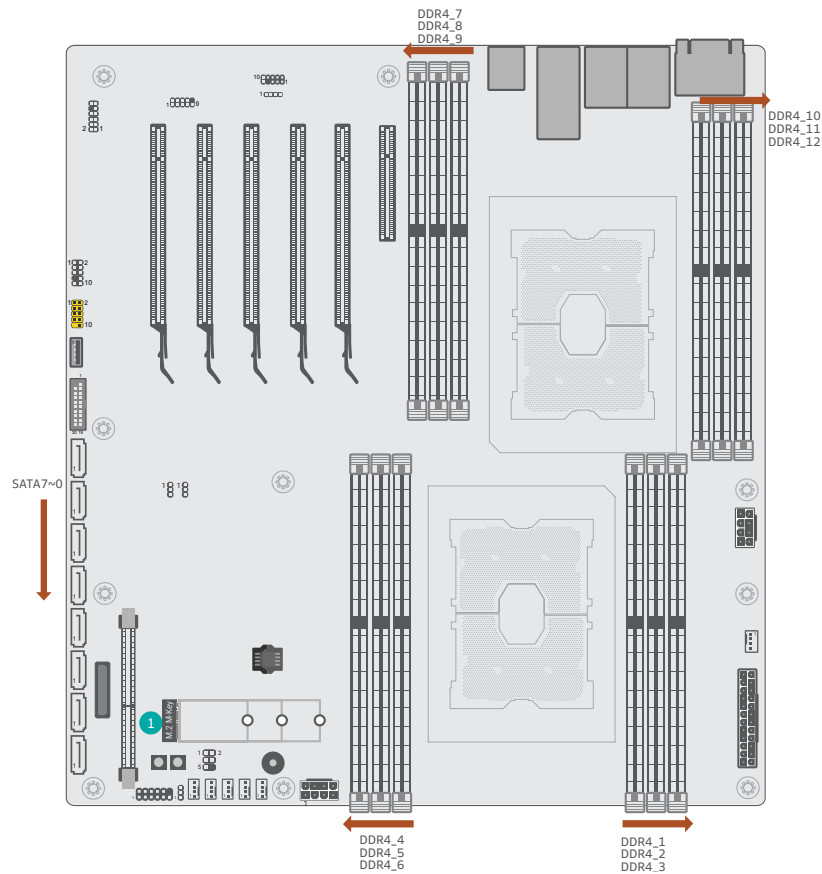

1 M.2 M-Key

Installing the M.2 Module

Before installing the M.2 module into the M.2 socket, please make sure that the following safety cautions are well-attended.

1. Make sure the PC and all other peripheral devices connected to it has been powered down.
2. Disconnect all power cords and cables.
3. Locate the M.2 socket on the system board
4. Make sure the notch on card is aligned to the key on the socket.
5. Make sure the standoff screw is removed from the standoff.

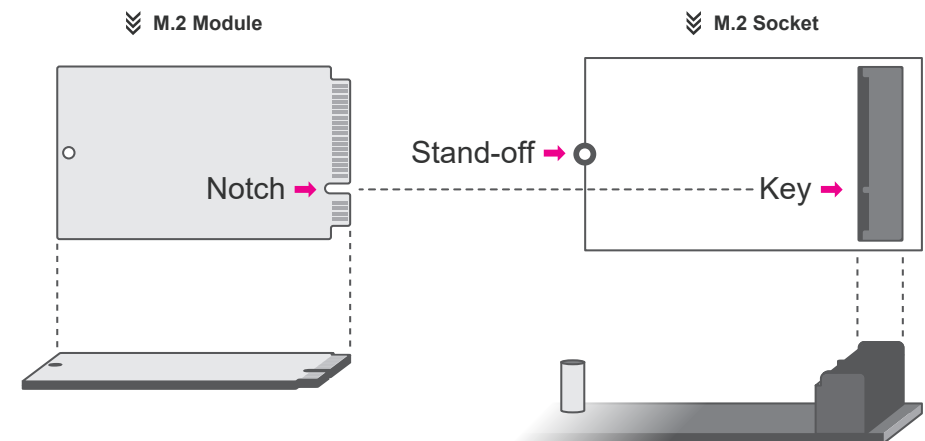

Please follow the steps below to install the card into the socket.

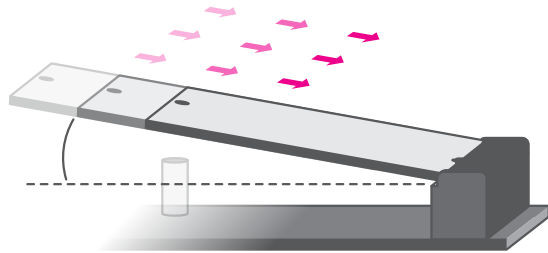

Step 1:
Insert the card into the socket at an angle while making sure the notch and key are perfectly aligned.

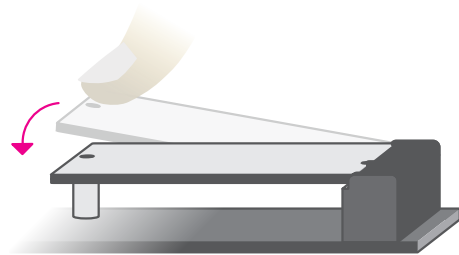

Step 2:
Press the end of the card far from the socket down until against the stand-off.

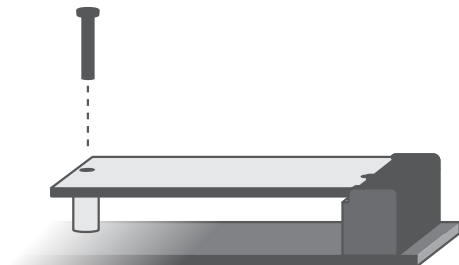

Step 3:
Screw tight the card onto the stand-off with a screw driver and a stand-off screw until the gap between the card and the stand-off closes up. The card should be lying parallel to the board when it's correctly mounted.

Chapter 3 - BIOS Settings

► Overview

The BIOS is a program that takes care of the basic level of communication between the CPU and peripherals. It contains codes for various advanced features found in this system board. The BIOS allows you to configure the system and save the configuration in a battery-backed CMOS so that the data retains even when the power is off. In general, the information stored in the CMOS RAM of the EEPROM will stay unchanged unless a configuration change has been made such as a hard drive replaced or a device added. It is possible that the CMOS battery will fail causing CMOS data loss. If this happens, you need to install a new CMOS battery and reconfigure the BIOS settings.



Note:

The BIOS is constantly updated to improve the performance of the system board; therefore the BIOS screens in this chapter may not appear the same as the actual one. These screens are for reference purpose only.

Default Configuration

Most of the configuration settings are either predefined according to the Load Optimal Defaults settings which are stored in the BIOS or are automatically detected and configured without requiring any actions. There are a few settings that you may need to change depending on your system configuration.

Entering the BIOS Setup Utility

The BIOS Setup Utility can only be operated from the keyboard and all commands are keyboard commands. The commands are available at the right side of each setup screen. The BIOS Setup Utility does not require an operating system to run. After you power up the system, the BIOS message appears on the screen and the memory count begins. After the memory test, the message "Press DEL to run setup" will appear on the screen. If the message disappears before you respond, restart the system or press the "Reset" button. You may also restart the system by pressing the <Ctrl> <Alt> and keys simultaneously.

Legends

Keys	Function
Right / Left arrow	Move the highlight left or right to select a menu
Up / Down arrow	Move the highlight up or down between submenus or fields
<Enter>	Enter the highlighted submenu
+ (plus key)/F6	Scroll forward through the values or options of the highlighted field
- (minus key)/F5	Scroll backward through the values or options of the highlighted field
<F1>	Display general help
<F2>	Display previous values
<F7>	Popup Boot Device List
<F9>	Optimized defaults
<F10>	Save and Exit
<Esc>	Return to previous menu

Scroll Bar

When a scroll bar appears to the right of the setup screen, it indicates that there are more available fields not shown on the screen. Use the up and down arrow keys to scroll through all the available fields.

Submenu

When "►" appears on the left of a particular field, it indicates that a submenu which contains additional options are available for that field. To display the submenu, move the highlight to that field and press <Enter>.

► Main

The Main menu is the first screen that you will see when you enter the BIOS Setup Utility.

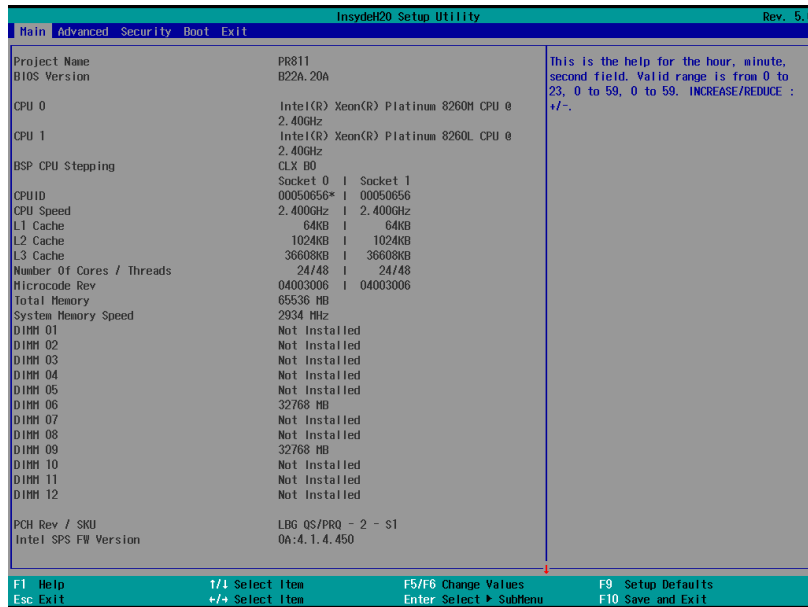

System Date

The date format is <month>, <date>, <year>. Press "Tab" to switch to the next field and press "-" or "+" to modify the value.

System Time

The time format is <hour>, <minute>, <second>. The time is based on the 24-hour military-time clock. For example, 1 p.m. is 13:00:00. Hour displays hours from 00 to 23. Minute displays minutes from 00 to 59. Second displays seconds from 00 to 59.

► Advanced

The Advanced menu allows you to configure your system for basic operation. Some entries are defaults required by the system board, while others, if enabled, will improve the performance of your system or let you set some features according to your preference.



Important:
Setting incorrect field values may cause the system to malfunction.

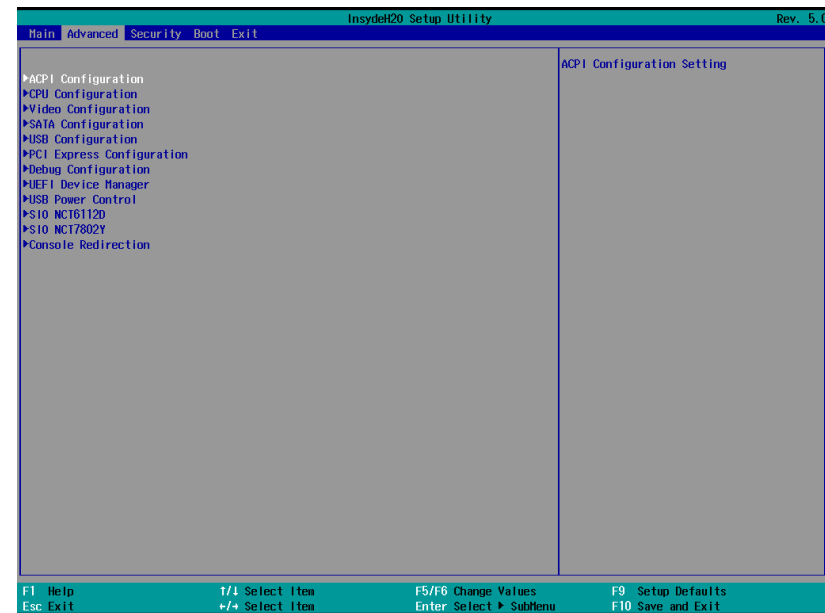

▶ Advanced

ACPI Configuration

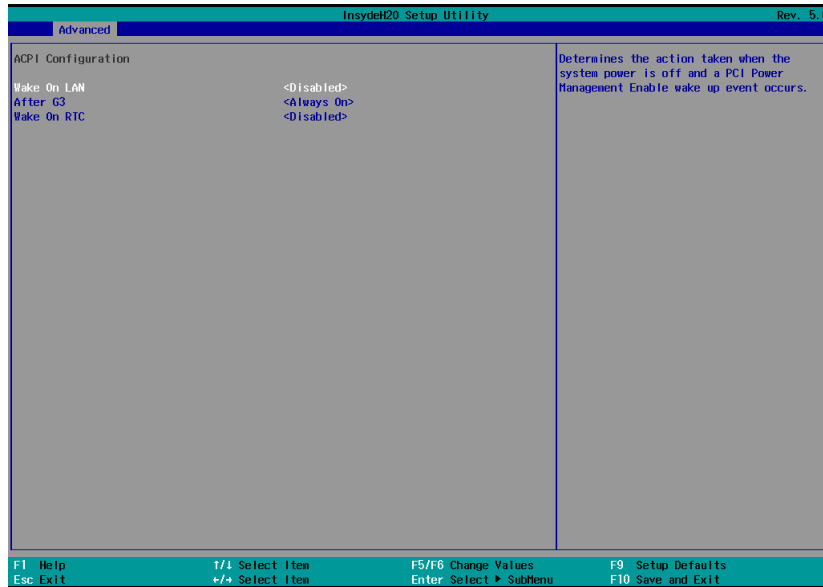

Wake on LAN

This field use to enable or disable the LAN signal to wake up the system.

State After G3

Specify what state to go to when power is reapplied after a power failure (G3 state).

- **Always Off / Always On**

Always On - The system automatically powers on after power failure.

Always Off - The system remains power off after power failure. Power-on signal input is re-quired to power up the system.

Wake on RTC

When Enabled, the system will automatically wake up from S4/S5 state at a designated time every day via the Real-time clock (RTC) battery.

▶ Advanced

CPU Configuration

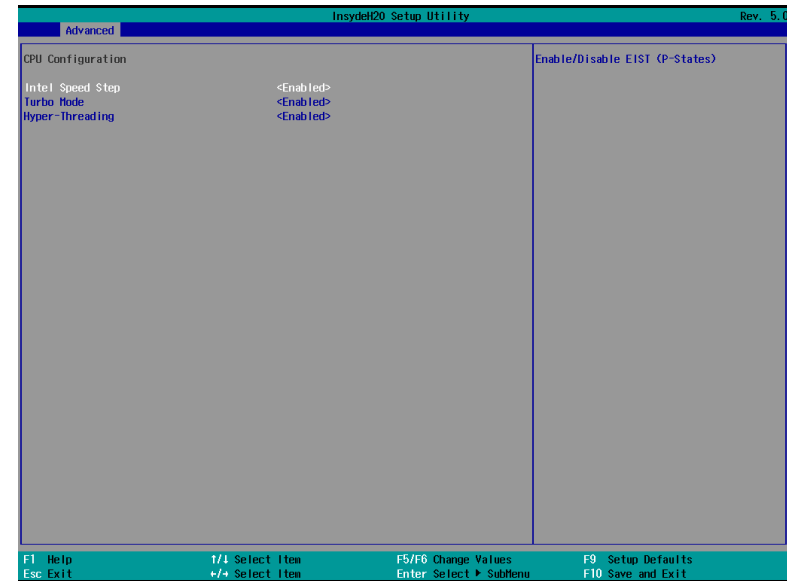

Intel Speed Step

This field is used to enable or disable the Enhanced Intel SpeedStep® Technology (EIST), which helps optimize the balance between system's power consumption and performance. After it is enabled in the BIOS, EIST features can then be enabled via the operating system's power management.

Turbo Mode

Enable or disable turbo mode of the processor. This field will only be displayed when "Intel Speed Step" is enabled. This field is not available when the equipped CPU does not support Turbo Mode.

Hyper-threading

Enable or disable Hyper-threading. When it is enabled, a physical core will perform as two logical processors, and the user may experience better computational efficiency of the system. Please make sure that the OS operating on your system is optimized for Hyper-Threading, e.g. Windows and Linux. This field is not available when the equipped CPU does not support Hyper-threading.

▶ Advanced

Video Configuration

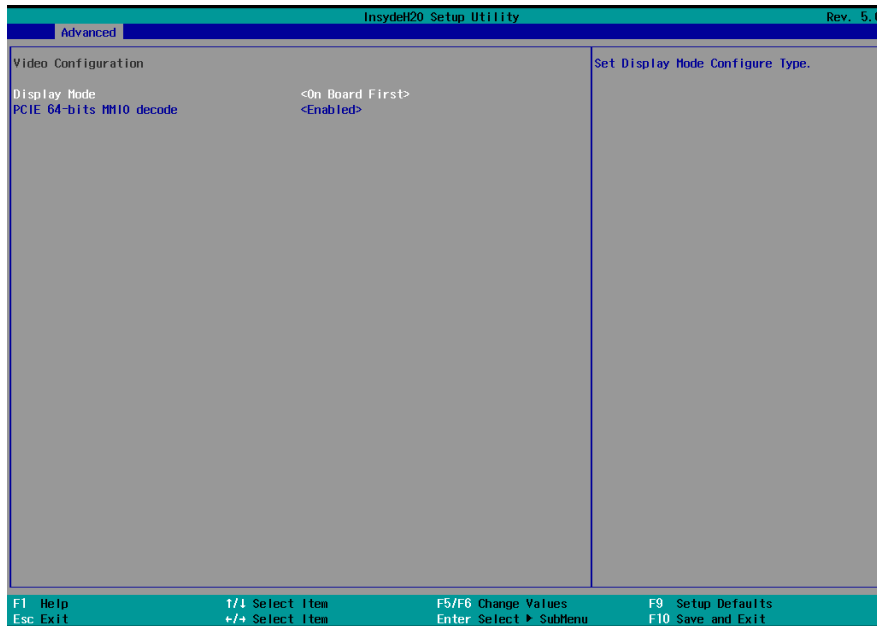

Display Mode

Select among On Board First and Plug In First to specify the display I/O source.

PCIe 64-bits MMIO decode

Select Enabled or Disabled to allocate MMIO resource of PCIe VGA card at 64-bits address. En-able it for specific VGA card that need huge resource. But it may cause VGA card to not display during boot in dual/legacy mode.

▶ Advanced

SATA Configuration

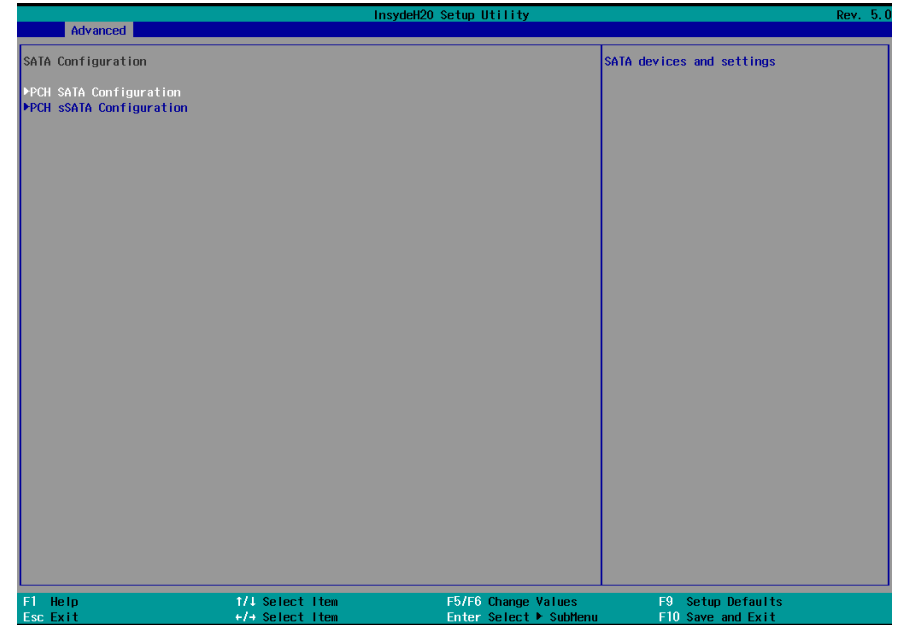

PCH SATA Configuration

Press Enter to enter the sub-menu and configure on-board SATA 3.0 controllers.

PCH sSATA Configuration

Press Enter to enter the sub-menu and configure the M.2 SATA storage device.

► Advanced

SATA Configuration ► PCH SATA Configuration



SATA Controller(s)

Enable or disable the Serial ATA controller. This following fields will only be displayed when this field is enabled.

SATA Speed

Select Serial ATA controller(s) speed – Auto, Gen1 (1.5 Gbit/s), Gen2 (3 Gbit/s) or Gen 3 (6 Gbit/s).

SATA Mode Selection

The mode selection determines how the SATA controller(s) operates.

AHCI This option allows the Serial ATA controller(s) to use AHCI (Advanced Host Control-ler Interface).

RAID This option allows the Serial ATA controller(s) to use UEFI, RAID, and Intel Rapid Storage Technology.

SATA Port 0-7/Hot Plug

Enable or disable each Serial ATA port and its hot plug function.

► Advanced

SATA Configuration ► PCH sSATA Configuration

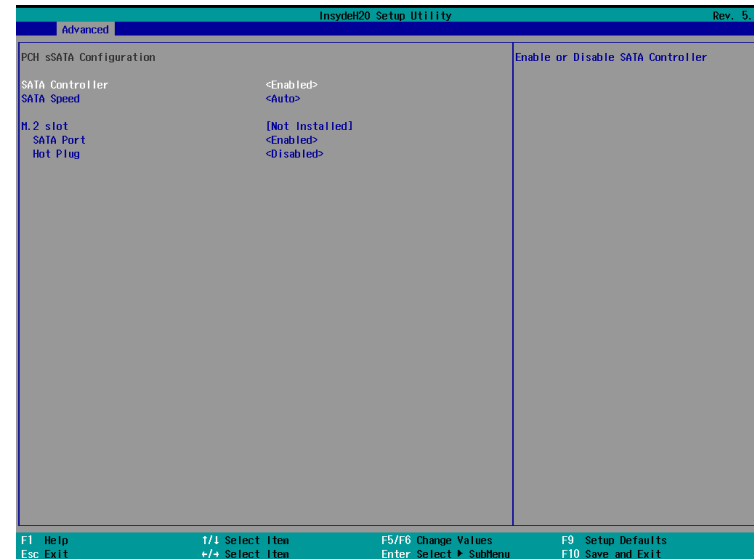

SATA Controller(s)

Enable or disable the Serial ATA controller. This following fields will only be displayed when this field is enabled.

SATA Speed

Select Serial ATA controller(s) speed – Auto, Gen1 (1.5 Gbit/s), Gen2 (3 Gbit/s) or Gen 3 (6 Gbit/s).

M.2 SATA Port / Hot Plug

Enable or disable each Serial ATA port and its hot plug function.

► **Advanced**

USB Configuration

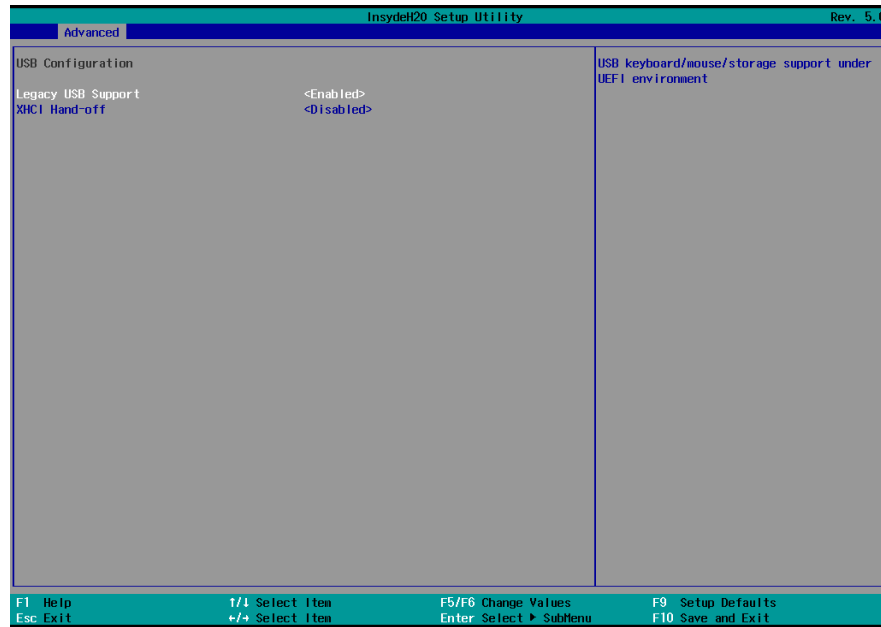

Legacy USB Support

- **Enabled** Enable Legacy USB support.
- **Disabled** Keep USB devices available only for EFI applications.

XHCI Hand-off

Enable or disable XHCI Hand-off.

► **Advanced**

PCI Express Configuration

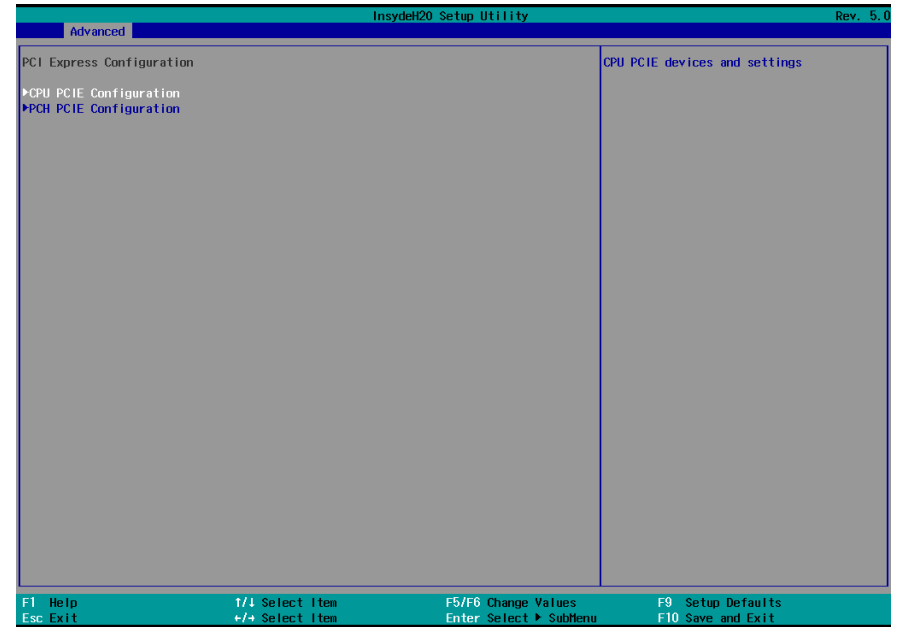

CPU PCIE Configuration

Press Enter to enter the sub-menu and configure the PCIE ports – PCIE1, PCIE2, PCIE3, PCIE4, PCIE5, PCIE6.

PCH PCIE Configuration

Press Enter to enter the sub-menu and configure the PCIE devices – LAN1, LAN2, and M.2 slot.

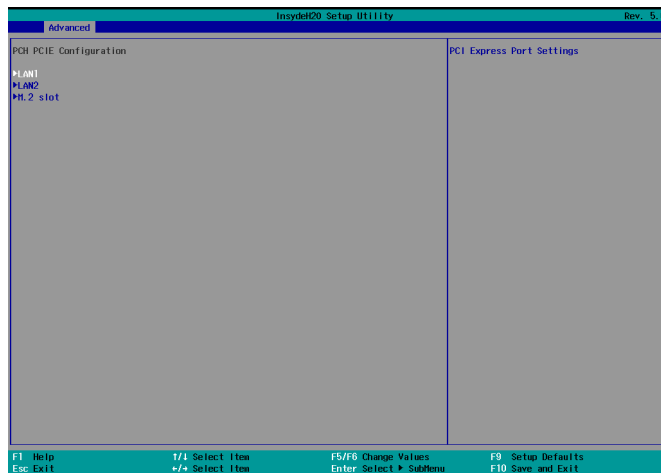
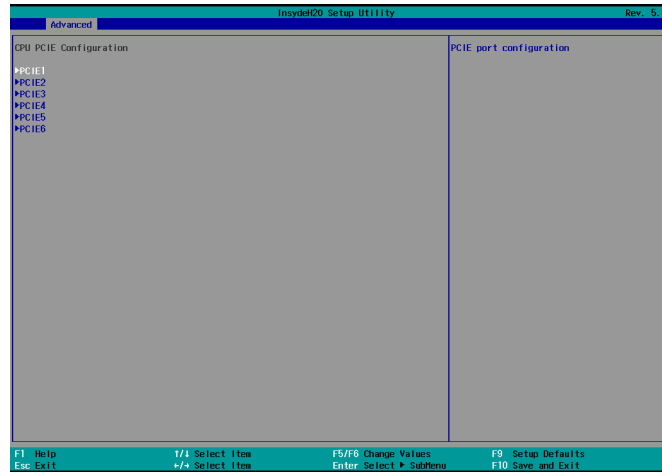

PCIE1/PCIE2/PCIE3/PCIE4/PCIE5/PCIE6/LAN1/LAN2/M.2 slot

Port Enable

Enable or disable the PCI Express Root Port.

PCIe Speed

Select PCIe Speed of the current port – AUTO, Gen1 (2.5 GT/s), Gen2 (5 GT/s), or Gen3 (8 GT/s). Gen 3 is only available for the PCIE1 port. This field may not appear when the speed of the port is not configurable.

Hot Plug

Enable or disable hot plug function of the port. This field may not appear when the port does not support hot plug.

▶ Advanced

Debug Configuration

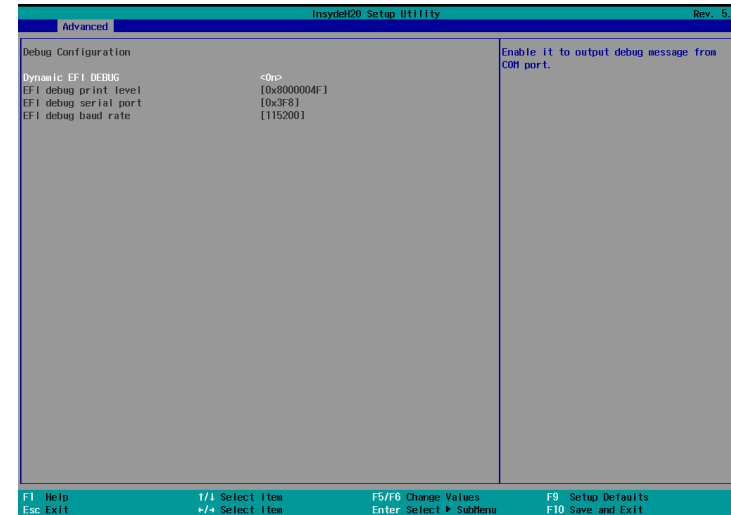

Dynamic EFI DEBUG

This field is used to turn on or off the function to output debug message from COM port. When this field is set to “On”, the following EFI debug configurations will be displayed.

EFI debug print level

Enter the numeric value for EFI debug print level. The default is 0x8000004F.

EFI debug serial port

Enter the serial port to output EFI debug message. The default is 0x3F8.

EFI debug baud rate

Enter the baud rate to output EFI debug message. The default is 115200.

▶ Advanced

UEFI Device Manager

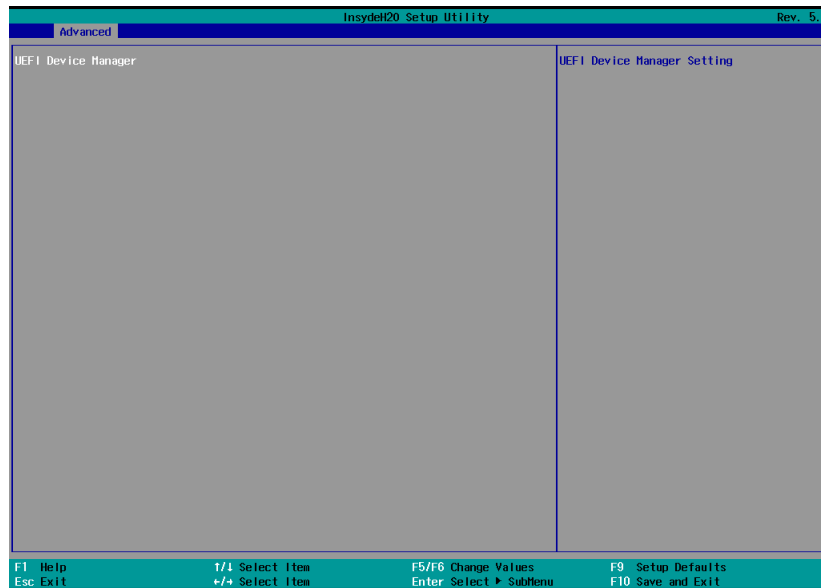

UEFI Device Manager

Configure UEFI device with option ROM, such as LAN card, etc.

Press "Enter" and "OK" to enter UEFI Device Manager setup page. More device settings can be configured in the UEFI Device Manager, including LAN, Network Stacks, and etc.



Note: Network Device will not be configurable in Device Manager if "Network Stack" is disabled in the "Boot" menu.

▶ Advanced

USB Power Control

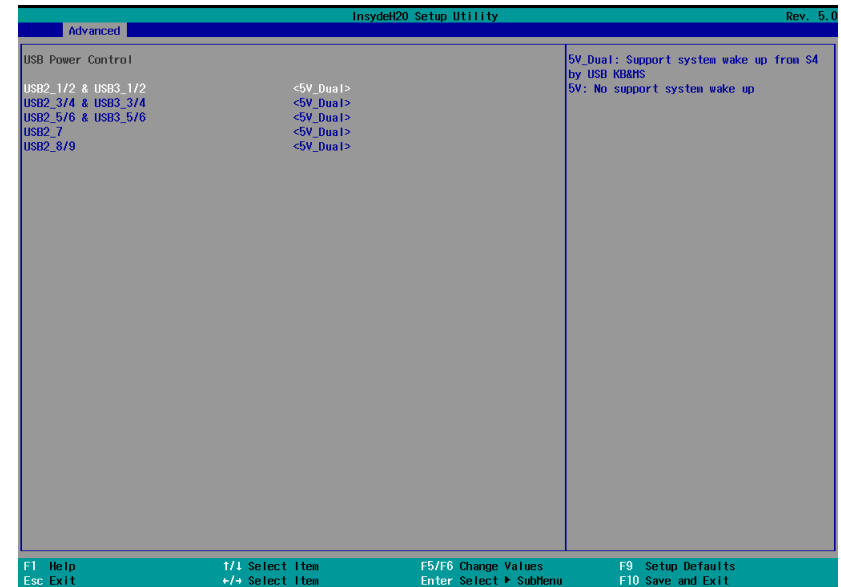

Switch USB Power Type

5_Dual: Support system wake up from S3/S4 by USB KB&MS

5V: No support system wake up from S3/S4 by USB KB&MS

► **Advanced**

SIO NCT6112D

Configure Super I/O settings in this submenu. Scroll by moving the cursor up or down to reveal more options.

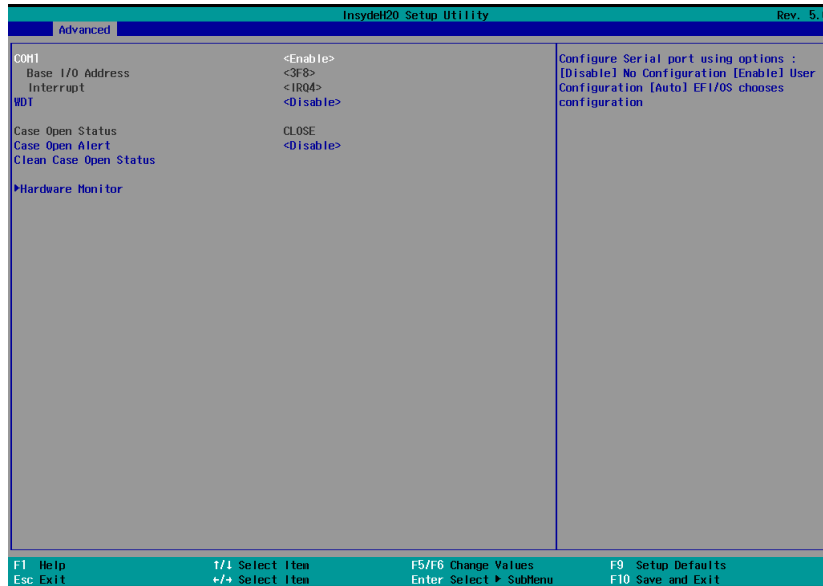

COM1

Enables or disables the serial ports (COM). The following bracketed fields will only appear when the port is enabled.

WDT

Enable or disable the Watchdog Timer (WDT) function. A counter will appear if you select to enable WDT. Input any value between 1 to 255 seconds.

WDT = [Enable]

Counter

Set the timeout value of the WDT – 1-255 seconds.

Case Open Alert

Enable or disable case open alert.

Clean Case Open Status

Clean current case open status including alert.

▶ Advanced

SIO NCT6112D ▶ Hardware Monitor

This section displays the PC health status.

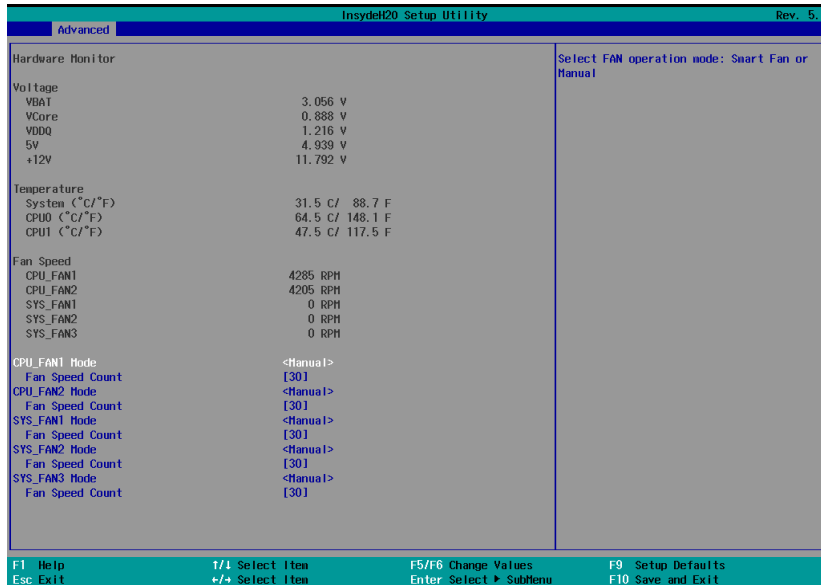

CPU / Sytem Fan Mode = [Smart Fan]

Boundary 0 to Boundary 3

Set the boundary temperatures that determine the fan speeds accordingly, the value ranging from 0-127 degrees. For example, when the system temperature reaches Boundary 1 setting, the fan speed will be turned up to the designated speed of the Fan Speed Count 1 field.

Fan Speed Count 0 to Fan Speed Count 3

Set the fan speed, the value ranging from 1-100%, 100% being full speed. The fans will operate according to the specified boundary temperatures above-mentioned.

CPU / Sytem Fan Mode = [Manual]

Fan Speed Count

Set the fan speed, the value ranging from 1-100%, 100% being full speed. The fans will always operate at the specified speed regardless of gauged temperatures.

Smart Fan

Smart Fan is a fan speed moderation strategy that depends on the current system temperature. When the system temperature goes higher than the Boundary setting, the fan speed will be turned up to the setting of the Fan Speed Count that bears the same index as the Boundary field.

SYS Smart Fan/CPU Smart Fan Control

Enable or disable the system smart fan. When disabled, fan speed will not be controllable according to different system temperatures. Instead, a Fix Fan Speed Count field will be displayed to configure at which speed the fan will always be fixed regardless of system temperature.

► Advanced

SIO NCT7802Y ► Hardware Monitor

This section displays the PC health status.

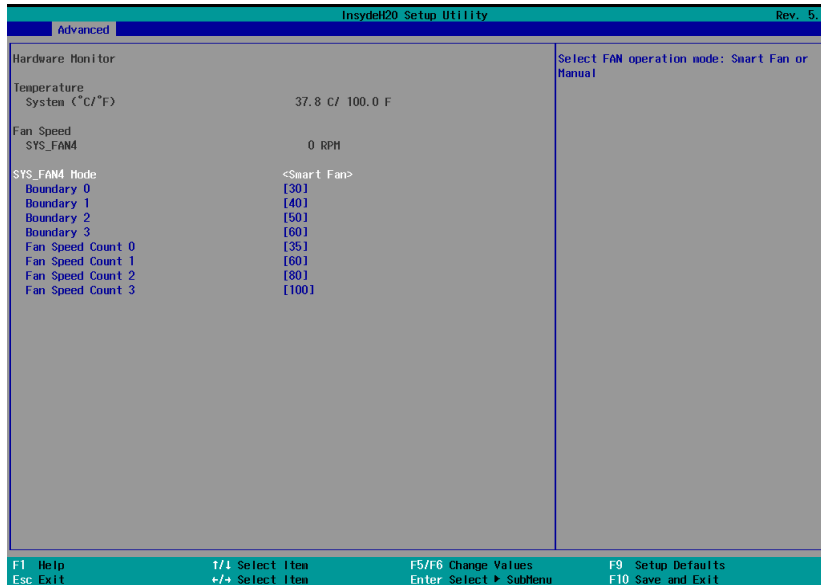

System Fan Mode = [Smart Fan]

Boundary 0 to Boundary 3

Set the boundary temperatures that determine the fan speeds accordingly, the value ranging from 0-127 degrees. For example, when the system temperature reaches Boundary 1 setting, the fan speed will be turned up to the designated speed of the Fan Speed Count 1 field.

Fan Speed Count 0 to Fan Speed Count 3

Set the fan speed, the value ranging from 1-100%, 100% being full speed. The fans will operate according to the specified boundary temperatures above-mentioned.

Smart Fan

Smart Fan is a fan speed moderation strategy that depends on the current system temperature. When the system temperature goes higher than the Boundary setting, the fan speed will be turned up to the setting of the Fan Speed Count that bears the same index as the Boundary field.

SYS Smart Fan Control

Enable or disable the system smart fan. When disabled, fan speed will not be controllable according to different system temperatures. Instead, a Fix Fan Speed Count field will be displayed to configure at which speed the fan will always be fixed regardless of system temperature.

► **Advanced**

Console Redirection

Configure COM port serial settings in the submenu.

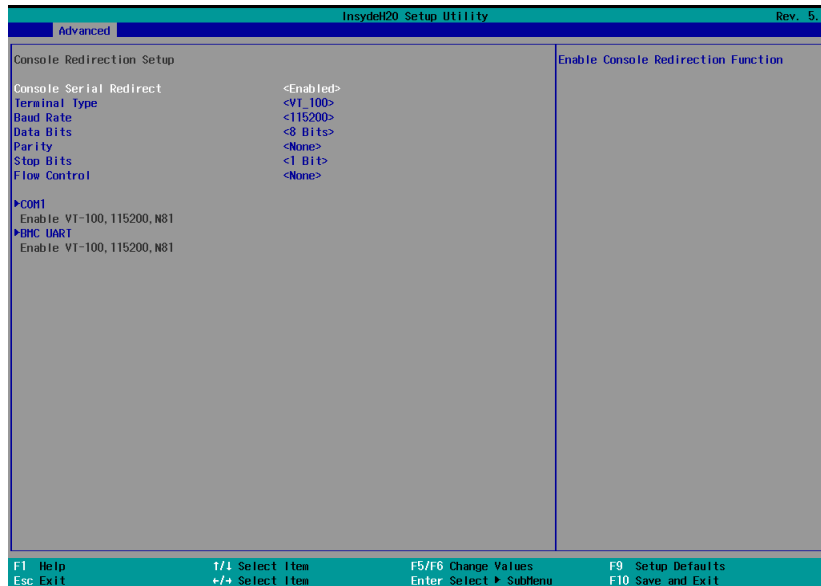

Terminal Type

Select terminal type – VT_100, VT_100+, VT_UTF8 or PC_ANSI.

Baud Rate

Select baud rate – 115200, 57600, 38400, 19200, 9600, 4800, 2400 or 1200.

Data Bits

Select data bits – 7 bits or 8 bits.

Parity

Select parity bits – none, even or odd.

Stop Bits

Select stop bits – 1 bit or 2 bits.

Flow Control

Select flow control type – none, RTS/CTS or XON/XOFF.

► Security

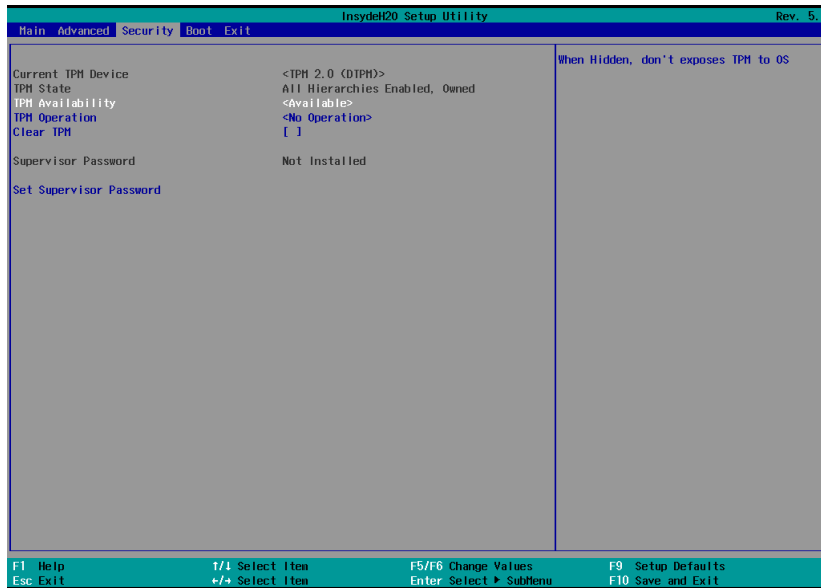

TPM Availability

Show or hide the TPM availability and its configurations.

TPM Operation

Select one of the supported operation to change TPM2 state – No Operation, Enable, or Disable.

Clear TPM

Remove all TPM context associated with a specific Owner.

Set Supervisor Password

Set the supervisor’s password. The length of the password must be greater than one character.



Note: The devices shown here are based on a carrier board that may not resemble your actual carrier board. The actual I/O devices depend entirely on those present on your actual carrier board.

► Boot

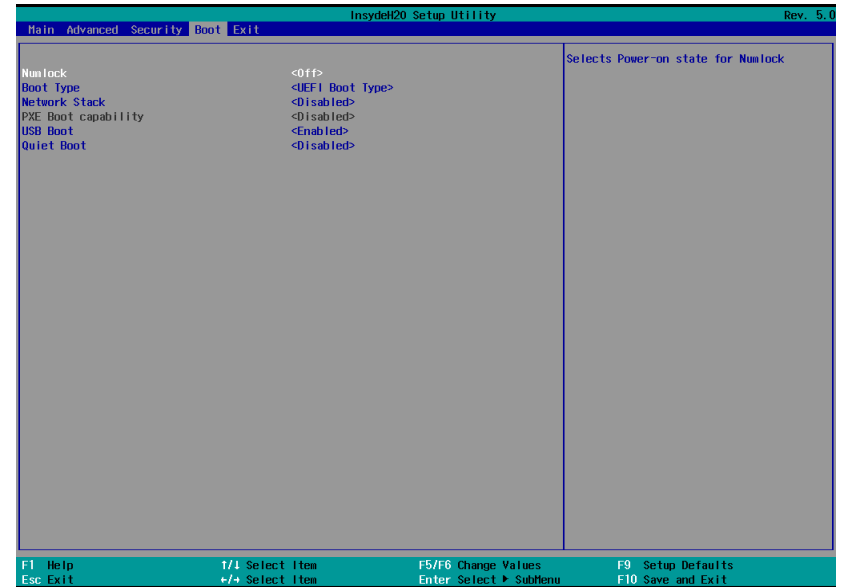

Numlock

Select the power-on state for numlock.

Boot Type

Select the boot type – UEFI Boot Type, Legacy Boot Type or Dual Boot Type. If you select “UEFI Boot Type” or “Dual Boot Type”, the “Network Stack”, “PXE Boot capability”, “USB Boot” and “Quiet Boot” will show up. If you select “Legacy Boot Type”, “PXE Boot to LAN”, “USB Boot” and “Quiet Boot” will show up.

Network Stack

This field is used to enable or disable network stacks, i.e. IPv4 or IPv6 network protocols.

USB Boot

Enable or disable booting to USB boot devices.

Quiet Boot

Enable or disable booting in text mode.



Note: Please press F10 to save the settings and re-start the system board after changing “Boot Type”.

► Save & Exit

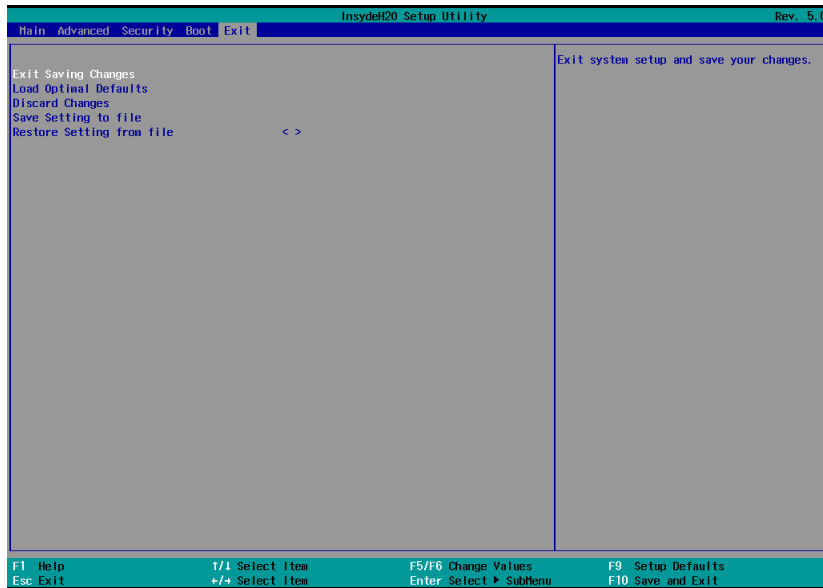

Exit Saving Changes

Select Yes and press <Enter> to exit the system setup and save your changes.

Load Optimal Defaults

Select YES and press <Enter> to load optimal defaults.

Discard Changes

Select YES and press <Enter> to exit the system setup without saving your changes.

Save Setting to file

Select this option to save BIOS configuration settings to a USB flash device.

Restore Setting from file

This field will appear only when a USB flash device is detected. Select this field to restore setting from the USB flash device.

► Updating the BIOS

To update the BIOS, you will need the new BIOS file and a flash utility. Please contact technical support or your sales representative for the files and specific instructions about how to update BIOS with the flash utility.

► Notice: BIOS SPI ROM

1. The Intel® Management Engine has already been integrated into this system board. Due to the safety concerns, the BIOS (SPI ROM) chip cannot be removed from this system board and used on another system board of the same model.
2. The BIOS (SPI ROM) on this system board must be the original equipment from the factory and cannot be used to replace one which has been utilized on other system boards.
3. If you do not follow the methods above, the Intel® Management Engine will not be updated and will cease to be effective.



Note:

- a. You can take advantage of flash tools to update the default configuration of the BIOS (SPI ROM) to the latest version anytime.
- b. When the BIOS IC needs to be replaced, you have to populate it properly onto the system board after the EEPROM programmer has been burned and follow the technical person's instructions to confirm that the MAC address should be burned or not.
- c. After updating unique MAC Address from manufacturing, NVM will be protected immediately after power cycle. Users cannot update NVM or MAC address.